

Si/SiC Hybrid Module – EliteSiC, 3 Channel Symmetric Boost 1000 V, 200 A IGBT, 1200 V, 60 A SiC Diode, Q2 Package

NXH600B100H4Q2F2PG, NXH600B100H4Q2F2SG, NXH600B100H4Q2F2SG-R

The NXH600B100H4Q2 is a Si/SiC Hybrid three channel symmetric boost module. Each channel contains two 1000 V, 200 A IGBTs, and two 1200 V, 60 A SiC diodes. The module contains an NTC thermistor.

Features

- Extremely Efficient Trench with Field Stop Technology
- Low Switching Loss Reduces System Power Dissipation
- Module Design Offers High Power Density
- Low Inductive Layout
- Low Package Height
- Pb-Free, Halogen Free/BFR Free and RoHS Compliant

Typical Applications

- Solar Inverters
- Uninterruptable Power Supplies Systems

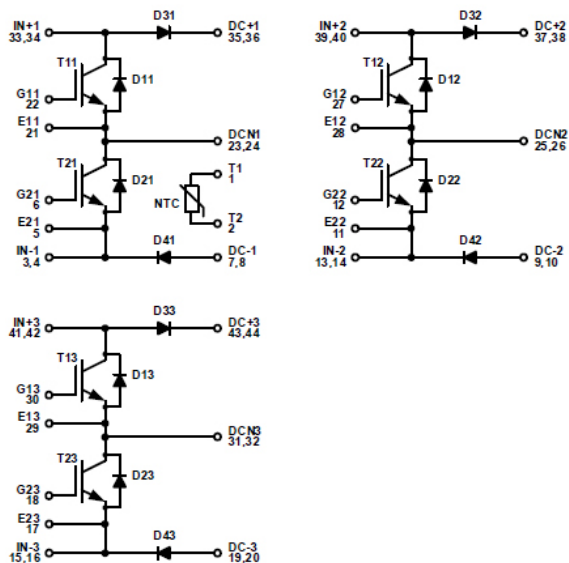
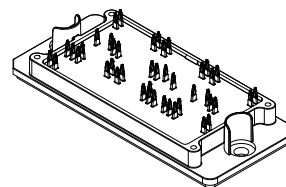
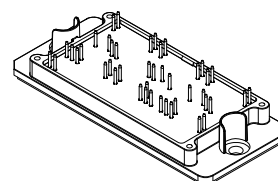

Figure 1. NXH600B100H4Q2F2 Schematic Diagram



PIM44, 93x47 (PRESS FIT)
CASE 180HF



PIM44, 93x47 (SOLDER PIN)
CASE 180HE

MARKING DIAGRAM

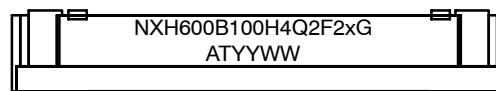

NXH600B100H4Q2F2xG = Device Code
 X = P or S
 G = Pb-Free Package
 AT = Assembly & Test Site Code
 YYWW = Year and Work Week Code

PIN CONNECTIONS

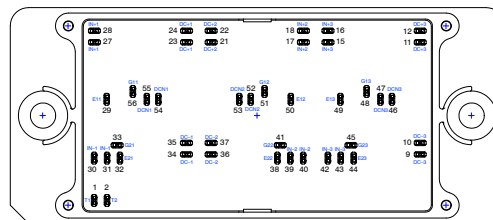

ORDERING INFORMATION

See detailed ordering and shipping information on page 11 of this data sheet.

NXH600B100H4Q2F2PG, NXH600B100H4Q2F2SG, NXH600B100H4Q2F2SG-R

ABSOLUTE MAXIMUM RATINGS (Note 1) $T_J = 25^\circ\text{C}$ unless otherwise noted

Parameter	Symbol	Value	Unit
IGBT (T11, T21, T12, T22, T13, T23)			
Collector-Emitter Voltage	V_{CES}	1000	V
Gate-Emitter Voltage Positive Transient Gate – Emitter Voltage (tpulse = 5 μs , $D < 0.10$)	V_{GE}	± 20 30	V
Continuous Collector Current @ $T_c = 80^\circ\text{C}$	I_C	192	A
Pulsed Peak Collector Current @ $T_c = 80^\circ\text{C}$ ($T_J = 175^\circ\text{C}$)	$I_{C(\text{Pulse})}$	576	A
Maximum Power Dissipation ($T_J = 175^\circ\text{C}$)	P_{tot}	511	W
Minimum Operating Junction Temperature	$T_{J\text{MIN}}$	-40	$^\circ\text{C}$
Maximum Operating Junction Temperature (Note 2)	$T_{J\text{MAX}}$	175	$^\circ\text{C}$

IGBT INVERSE DIODE (D11, D21, D12, D22, D13, D23)

Peak Repetitive Reverse Voltage	V_{RRM}	1200	V
Continuous Forward Current @ $T_c = 80^\circ\text{C}$	I_F	66	A
Repetitive Peak Forward Current ($T_J = 175^\circ\text{C}$)	I_{FRM}	198	A
Maximum Power Dissipation ($T_J = 175^\circ\text{C}$)	P_{tot}	101	W
Minimum Operating Junction Temperature	$T_{J\text{MIN}}$	-40	$^\circ\text{C}$
Maximum Operating Junction Temperature	$T_{J\text{MAX}}$	175	$^\circ\text{C}$

SILICON CARBIDE SCHOTTKY DIODE (D31, D41, D32, D42, D33, D43)

Peak Repetitive Reverse Voltage	V_{RRM}	1200	V
Continuous Forward Current @ $T_c = 80^\circ\text{C}$	I_F	73	A
Repetitive Peak Forward Current ($T_J = 175^\circ\text{C}$)	I_{FRM}	219	A
Maximum Power Dissipation ($T_J = 175^\circ\text{C}$)	P_{tot}	217	W
Minimum Operating Junction Temperature	$T_{J\text{MIN}}$	-40	$^\circ\text{C}$
Maximum Operating Junction Temperature	$T_{J\text{MAX}}$	175	$^\circ\text{C}$

THERMAL PROPERTIES

Operating Temperature under Switching Condition	T_{VJOP}	-40 to 150	$^\circ\text{C}$
Storage Temperature Range	T_{stg}	-40 to 125	$^\circ\text{C}$

INSULATION PROPERTIES

Isolation Test Voltage, $t = 1 \text{ s}$, 50 Hz	V_{is}	4000	V_{RMS}
Creepage Distance		12.7	mm
Comparative Tracking Index	CTI	>600	

Stresses exceeding those listed in the Maximum Ratings table may damage the device. If any of these limits are exceeded, device functionality should not be assumed, damage may occur and reliability may be affected.

1. Refer to ELECTRICAL CHARACTERISTICS, RECOMMENDED OPERATING RANGES and/or APPLICATION INFORMATION for Safe Operating parameters.
2. Qualification at 175°C per discrete TO247.

NXH600B100H4Q2F2PG, NXH600B100H4Q2F2SG, NXH600B100H4Q2F2SG-R

ELECTRICAL CHARACTERISTICS ($T_J = 25^\circ\text{C}$ unless otherwise noted) (continued)

Parameter	Test Conditions	Symbol	Min	Typ	Max	Unit	
IGBT (T11, T21, T12, T22, T13, T23) CHARACTERISTICS							
Collector-Emitter Breakdown Voltage	$V_{GE} = 0\text{ V}, I_C = 1\text{ mA}$	$V_{(BR)CES}$	1000	1165	–	V	
Collector-Emitter Cutoff Current	$V_{GE} = 0\text{ V}, V_{CE} = 1000\text{V}$	I_{CES}	–	–	10	μA	
Collector-Emitter Saturation Voltage	$V_{GE} = 15\text{ V}, I_C = 200\text{ A}, T_J = 25^\circ\text{C}$	$V_{CE(sat)}$	–	1.69	2.3	V	
	$V_{GE} = 15\text{ V}, I_C = 200\text{ A}, T_J = 175^\circ\text{C}$		–	2.15	–		
Gate-Emitter Threshold Voltage	$V_{GE} = V_{CE}, I_C = 200\text{ mA}$	$V_{GE(TH)}$	3.8	4.75	6.6	V	
Gate Leakage Current	$V_{GE} = \pm 20\text{ V}, V_{CE} = 0\text{ V}$	I_{GES}	–	–	± 1	μA	
Internal Gate Resistor		r_g	–	2	–	Ω	
Turn-on Delay Time	$T_J = 25^\circ\text{C}$ $V_{CE} = 600\text{ V}, I_C = 50\text{ A}$ $V_{GE} = -9\text{ V}, 15\text{ V}, R_{gon} = 6\ \Omega,$ $R_{goff} = 6\ \Omega$	$t_{d(on)}$	–	111	–	ns	
Rise Time		t_r	–	15	–		
Turn-off Delay Time		$t_{d(off)}$	–	338	–		
Fall Time		t_f	–	113	–		
Turn-on Switching Loss per Pulse		E_{on}	–	460	–		μJ
Turn off Switching Loss per Pulse		E_{off}	–	1930	–		
Turn-on Delay Time	$T_J = 125^\circ\text{C}$ $V_{CE} = 600\text{ V}, I_C = 50\text{ A}$ $V_{GE} = -9\text{ V}, 15\text{ V}, R_{gon} = 6\ \Omega,$ $R_{goff} = 6\ \Omega$	$t_{d(on)}$	–	111	–	ns	
Rise Time		t_r	–	17	–		
Turn-off Delay Time		$t_{d(off)}$	–	406	–		
Fall Time		t_f	–	142	–		
Turn-on Switching Loss per Pulse		E_{on}	–	660	–		μJ
Turn off Switching Loss per Pulse		E_{off}	–	2860	–		
Input Capacitance	$V_{CE} = 20\text{ V}, V_{GE} = 0\text{ V}, f = 1\text{ MHz}$	C_{ies}	–	13256	–	pF	
Output Capacitance		C_{oes}	–	456	–		
Reverse Transfer Capacitance		C_{res}	–	78	–		
Total Gate Charge	$V_{CE} = 600\text{ V}, I_C = 40\text{ A}, V_{GE} = -15\text{V} \sim 15\text{ V}$	Q_g	–	766	–	nC	
Thermal Resistance – Chip-to-Heatsink	Thermal grease, Thickness = 2.1 Mil $\pm 2\%$ $\lambda = 2.87\text{ W/mK}$	R_{thJH}	–	0.45	–	K/W	
Thermal Resistance – Chip-to-Case		R_{thJC}	–	0.186	–	K/W	
IGBT INVERSE DIODE (D11, D21, D12, D22, D13, D23) CHARACTERISTICS							
Diode Forward Voltage	$I_F = 50\text{ A}, T_J = 25^\circ\text{C}$	V_F	–	1.10	1.55	V	
	$I_F = 50\text{ A}, T_J = 175^\circ\text{C}$		–	0.975	–		
Thermal Resistance – Chip-to-Heatsink	Thermal grease, Thickness = 2.1 Mil $\pm 2\%$ $\lambda = 2.87\text{ W/mK}$	R_{thJH}	–	0.98	–	K/W	
Thermal Resistance – Chip-to-Case		R_{thJC}	–	0.65	–	K/W	
DIODES (D31, D41, D32, D42, D33, D43) CHARACTERISTICS							
Diode Forward Voltage	$I_F = 60\text{ A}, T_J = 25^\circ\text{C}$	V_F	–	1.54	1.85	V	
	$I_F = 60\text{ A}, T_J = 175^\circ\text{C}$		–	2.27	–		
Reverse Recovery Time	$T_J = 25^\circ\text{C}$ $V_{CE} = 600\text{ V}, I_C = 50\text{ A}$ $V_{GE} = -9\text{ V}, 15\text{ V}, R_{gon} = 6\ \Omega$	t_{rr}	–	13	–	ns	
Reverse Recovery Charge		Q_{rr}	–	93	–	nC	
Peak Reverse Recovery Current		I_{RRM}	–	11	–	A	
Peak Rate of Fall of Recovery Current		di/dt	–	2767	–	A/ μs	
Reverse Recovery Energy		E_{rr}	–	45	–	μJ	

NXH600B100H4Q2F2PG, NXH600B100H4Q2F2SG, NXH600B100H4Q2F2SG-R

ELECTRICAL CHARACTERISTICS ($T_J = 25^\circ\text{C}$ unless otherwise noted) (continued)

Parameter	Test Conditions	Symbol	Min	Typ	Max	Unit
Reverse Recovery Time	$T_J = 125^\circ\text{C}$ $V_{CE} = 600\text{ V}, I_C = 50\text{ A}$ $V_{GE} = -9\text{ V}, 15\text{ V}, R_{gon} = 6\ \Omega$	t_{rr}	–	12	–	ns
Reverse Recovery Charge		Q_{rr}	–	90	–	nC
Peak Reverse Recovery Current		I_{RRM}	–	11	–	A
Peak Rate of Fall of Recovery Current		di/dt	–	2287	–	A/ μs
Reverse Recovery Energy		E_{rr}	–	32	–	μJ
Thermal Resistance – Chip-to-Heatsink	Thermal grease, Thickness = 2.1 Mil $\pm 2\%$ $\lambda = 2.87\text{ W/mK}$	R_{thJH}	–	0.68	–	K/W
Thermal Resistance – Chip-to-Case		R_{thJC}	–	0.438	–	K/W

THERMISTOR CHARACTERISTICS

Nominal Resistance	$T = 25^\circ\text{C}$	R_{25}	–	22	–	k Ω
Nominal Resistance	$T = 100^\circ\text{C}$	R_{100}	–	1504	–	Ω
Deviation of R25		$\Delta R/R$	–1	–	1	%
Power Dissipation		P_D	–	187.5	–	mW
Power Dissipation Constant			–	1.5	–	mW/K
B-value	$B(25/100)$, tolerance $\pm 1\%$		–	3980	–	K

Product parametric performance is indicated in the Electrical Characteristics for the listed test conditions, unless otherwise noted. Product performance may not be indicated by the Electrical Characteristics if operated under different conditions.

TYPICAL CHARACTERISTICS – IGBT, INVERSE DIODE AND BOOST DIODE

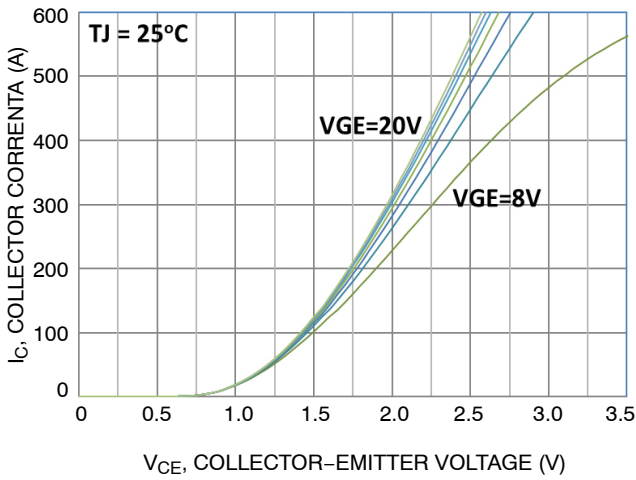

Figure 2. Typical Output Characteristics

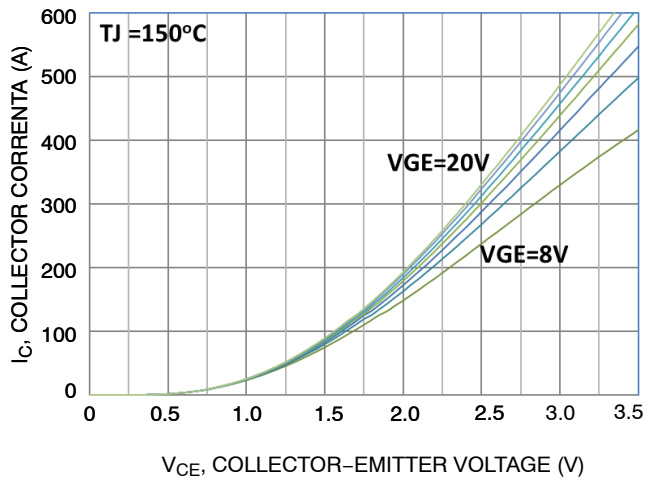

Figure 3. Typical Output Characteristics

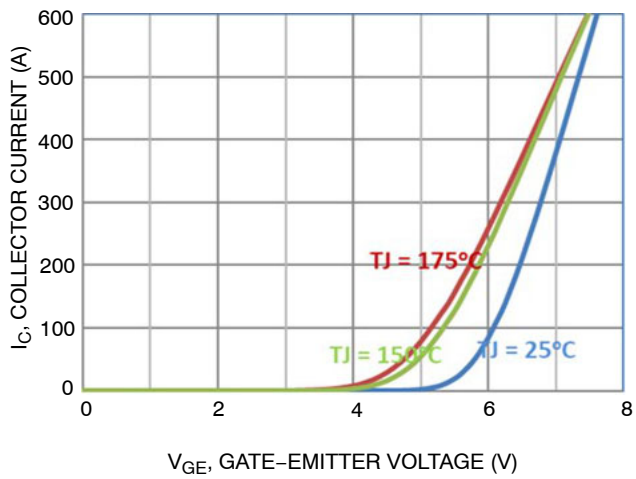

Figure 4. Transfer Characteristics

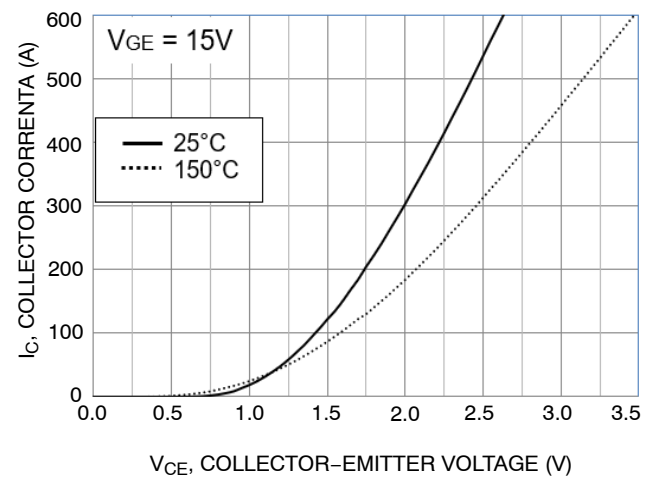

Figure 5. Saturation Voltage Characteristic

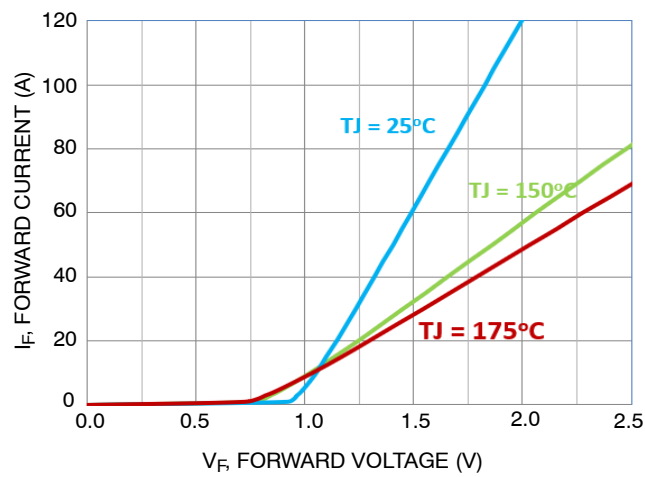

Figure 6. Boost Diode Forward Characteristics

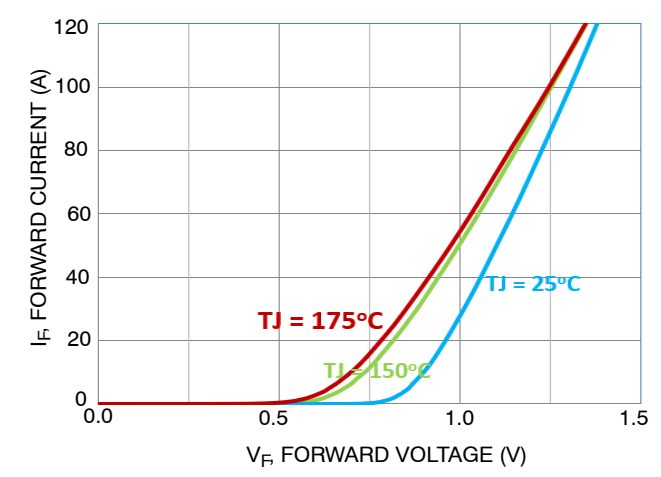

Figure 7. Inverse Diode Forward Characteristics

TYPICAL CHARACTERISTICS – IGBT AND BOOST DIODE

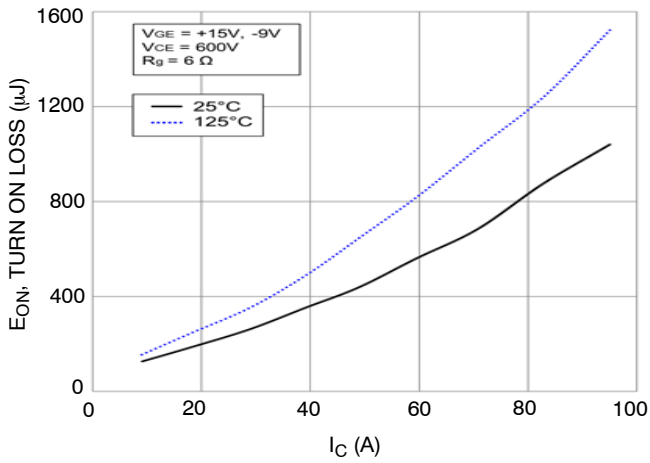

Figure 8. Typical Turn On Loss vs. Ic

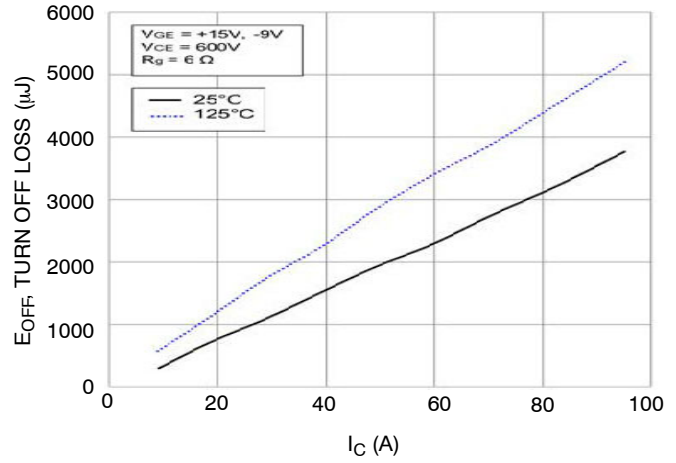

Figure 9. Typical Turn Off Loss vs. Ic

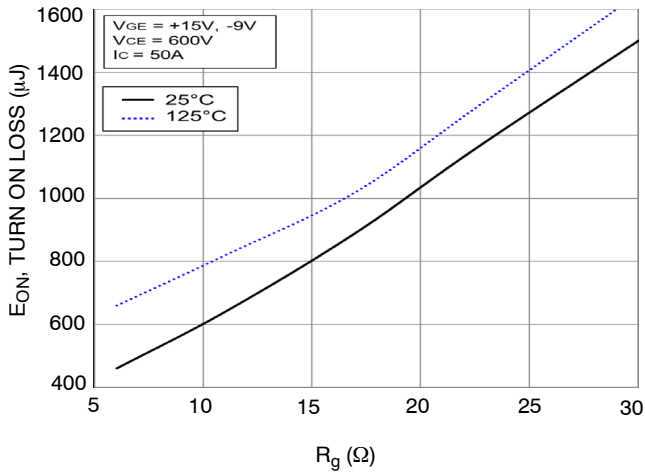

Figure 10. Typical Turn On Loss vs. Rg

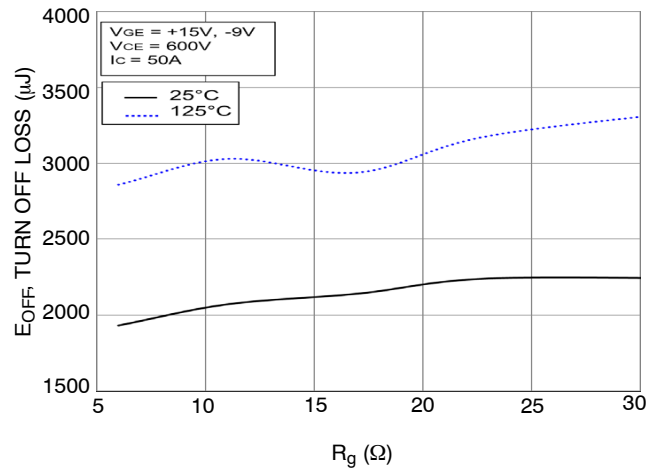

Figure 11. Typical Turn Off Loss vs. Rg

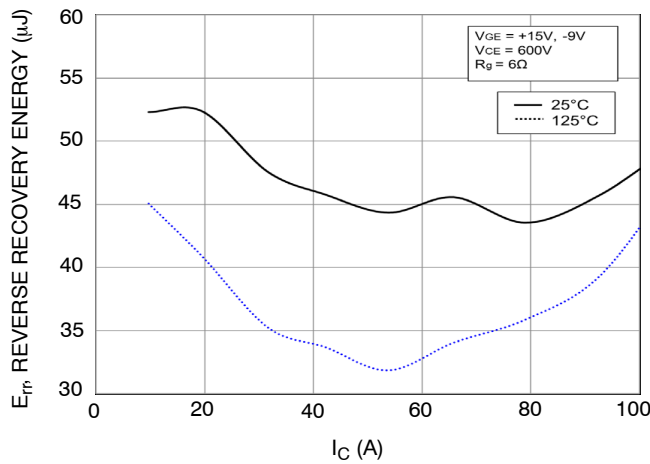

Figure 12. Typical Reverse Recovery Energy Loss vs. Ic

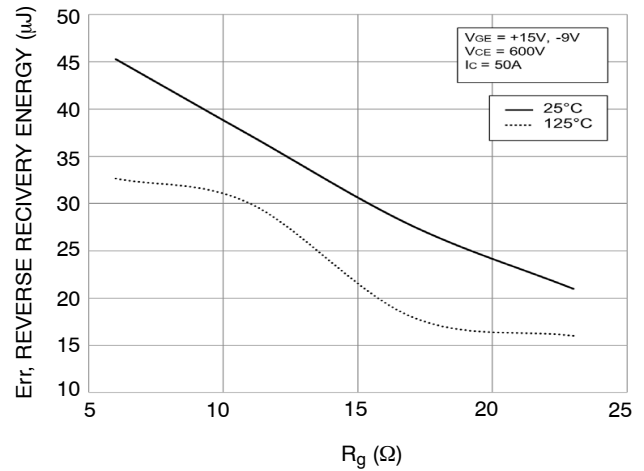

Figure 13. Typical Reverse Recovery Energy Loss vs. Rg

TYPICAL CHARACTERISTICS – IGBT AND BOOST DIODE (CONTINUED)

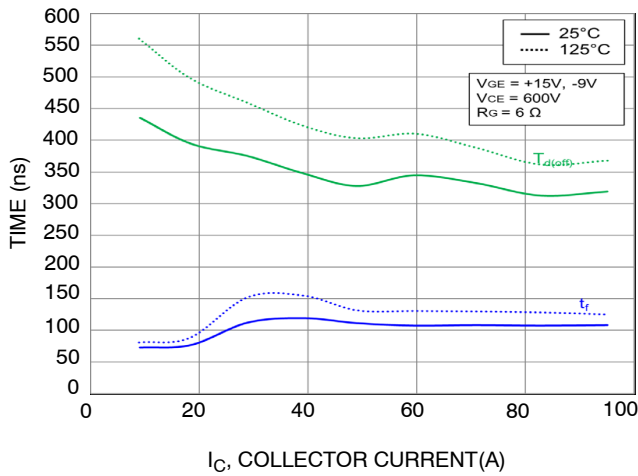

Figure 14. Typical Turn-Off Switching Time vs. I_C

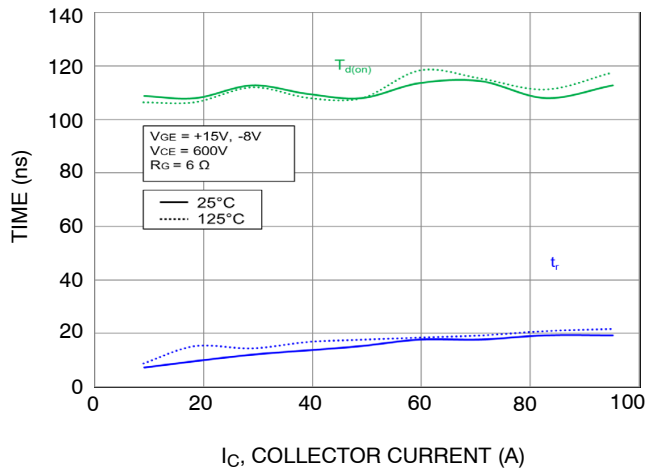

Figure 15. Typical Turn-On Switching Time vs. I_C

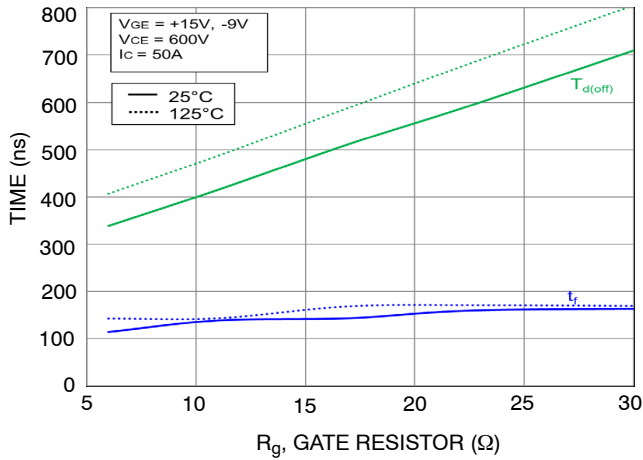

Figure 16. Typical Turn-Off Switching Time vs. R_g

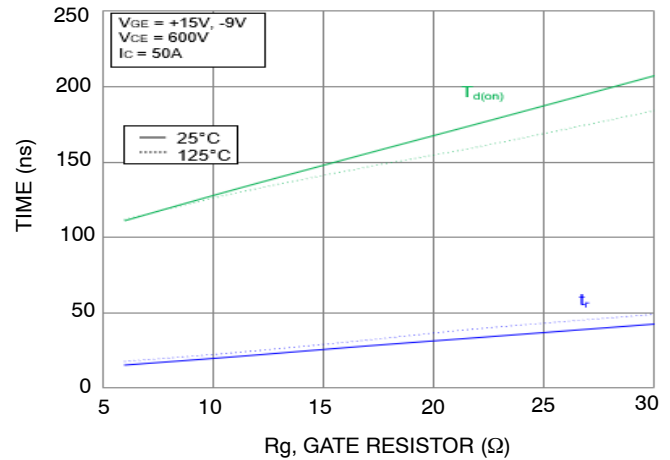

Figure 17. Typical Turn-On Switching Time vs. R_g

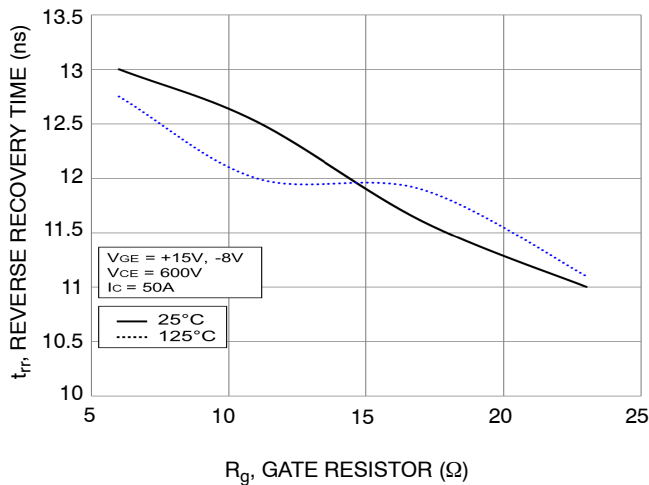

Figure 18. Typical Reverse Recovery Time vs. R_g

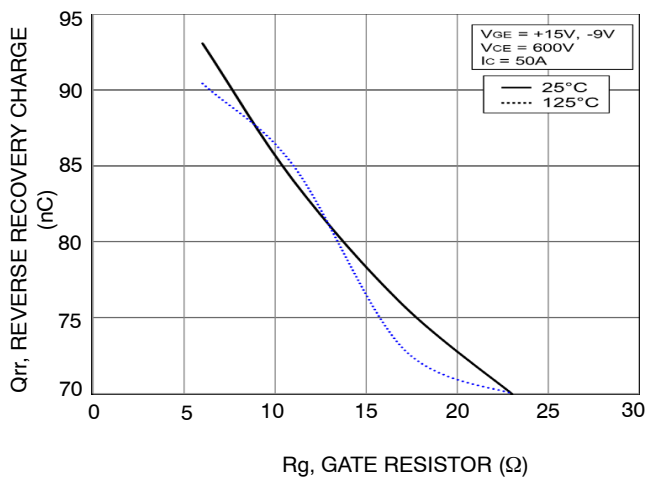

Figure 19. Typical Reverse Recovery Charge vs. R_g

TYPICAL CHARACTERISTICS – IGBT AND BOOST DIODE (CONTINUED)

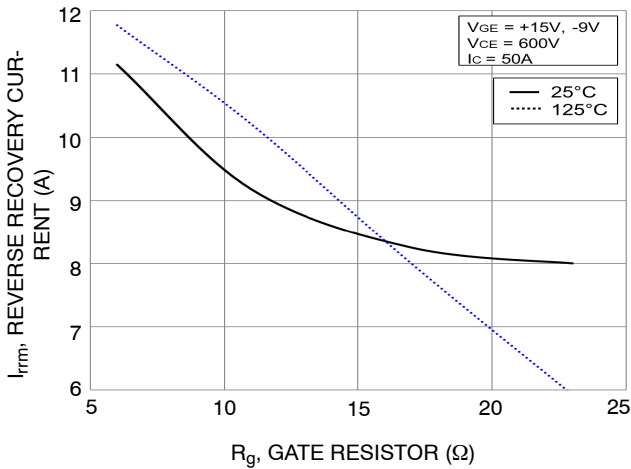

Figure 20. Typical Reverse Recovery Peak Current vs. R_g

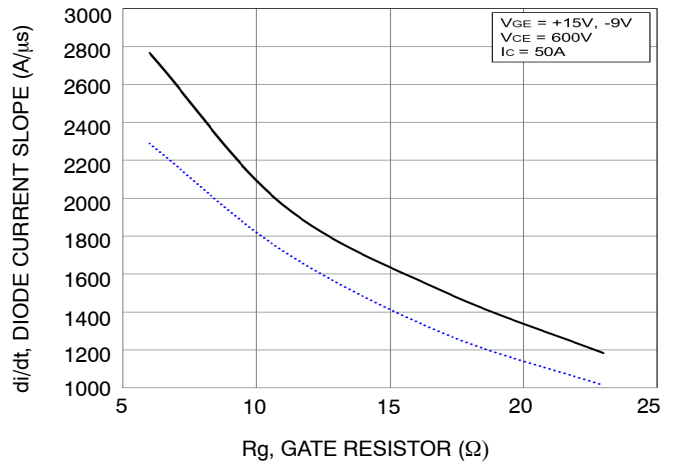

Figure 21. Typical di/dt vs. R_g

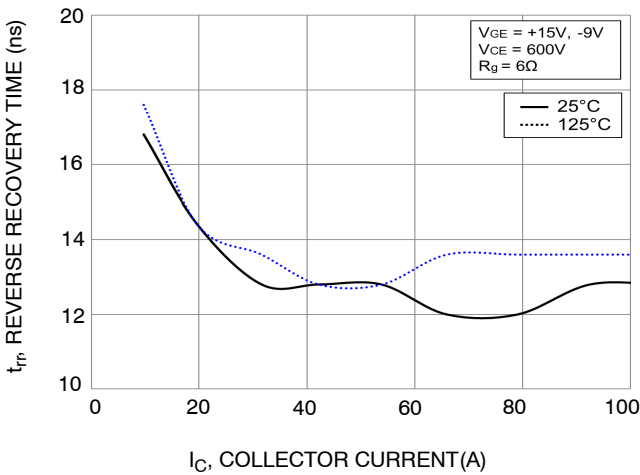

Figure 22. Typical Reverse Recovery Time vs. I_c

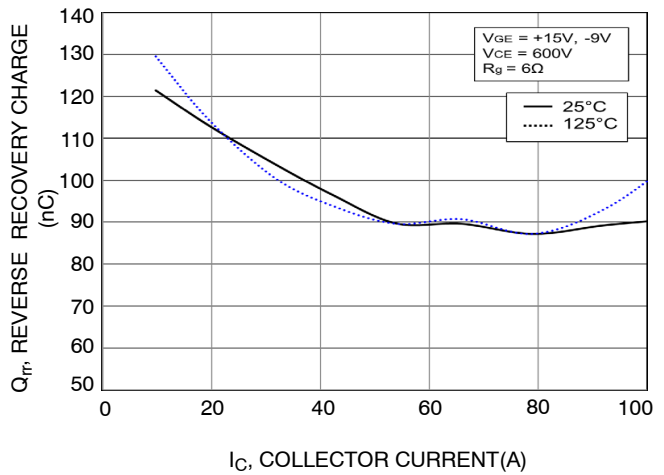

Figure 23. Typical Reverse Recovery Charge vs. I_c

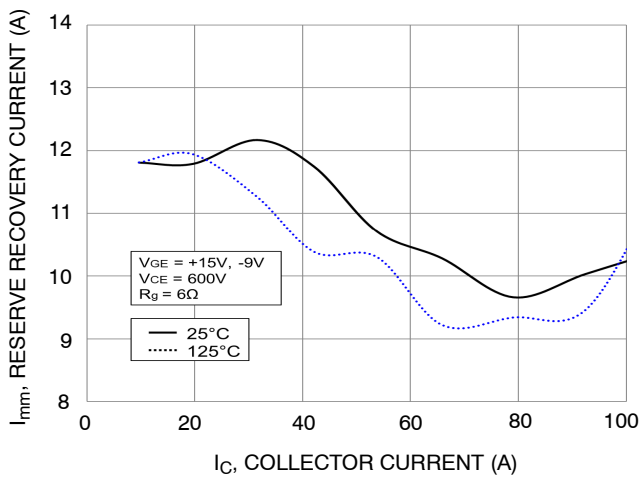

Figure 24. Typical Reserve Recovery Current vs. I_c

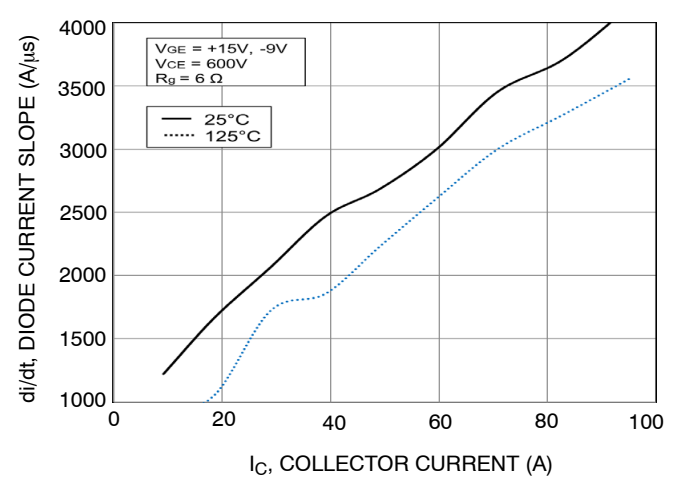

Figure 25. Typical di/dt vs. I_c

TYPICAL CHARACTERISTICS - IGBT

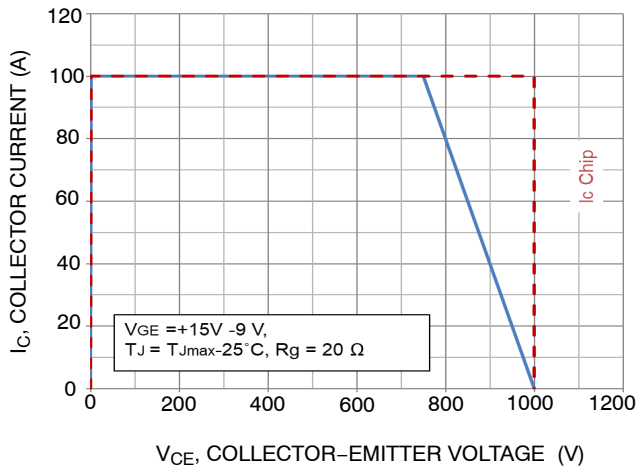

Figure 26. RBSOA

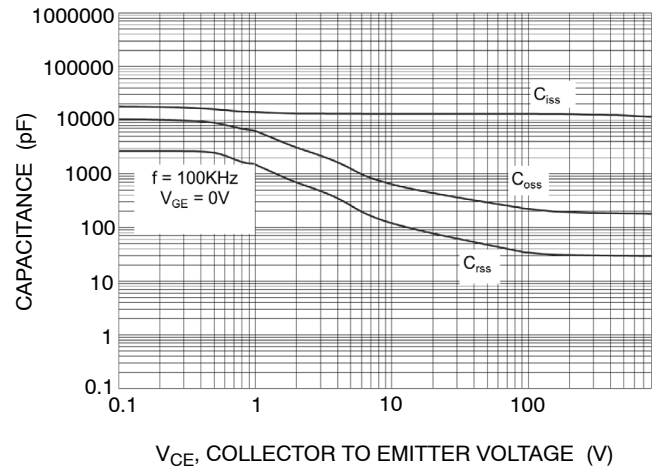

Figure 27. Capacitance Charge

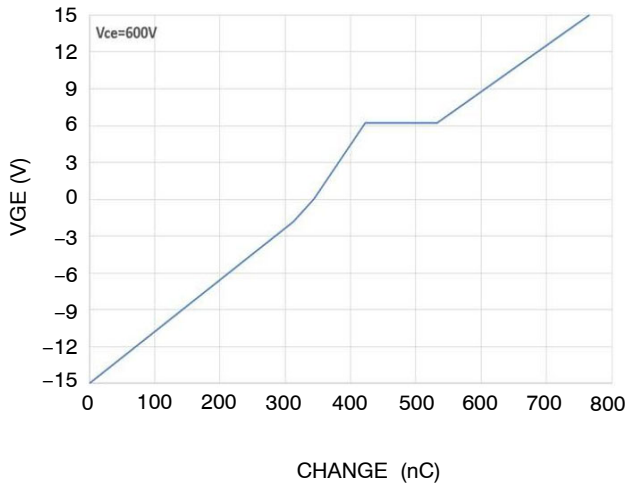

Figure 28. Gate Voltage vs. Gate Charge

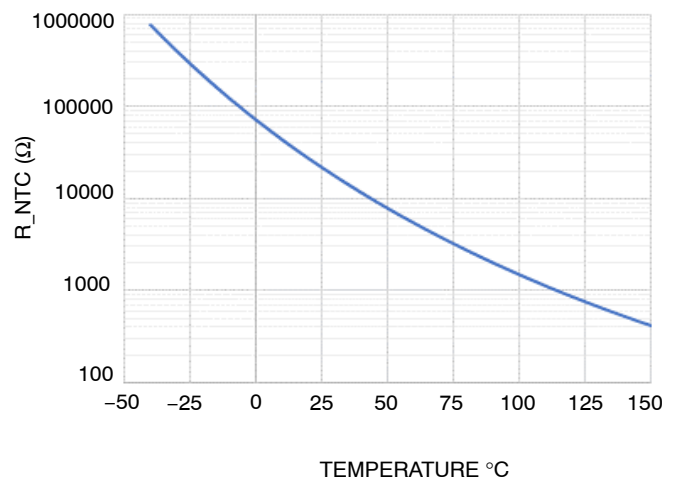

Figure 29. Temperature vs NTC Value

TYPICAL CHARACTERISTICS – IGBT, INVERSE DIODE AND BOOST DIODE

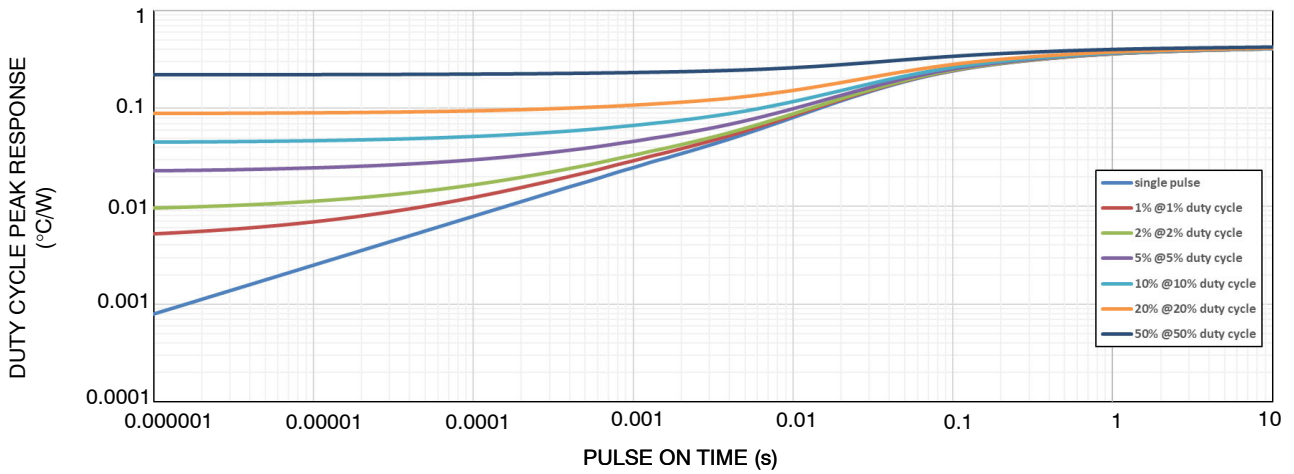

Figure 30. Transient Thermal Impedance (IGBT)

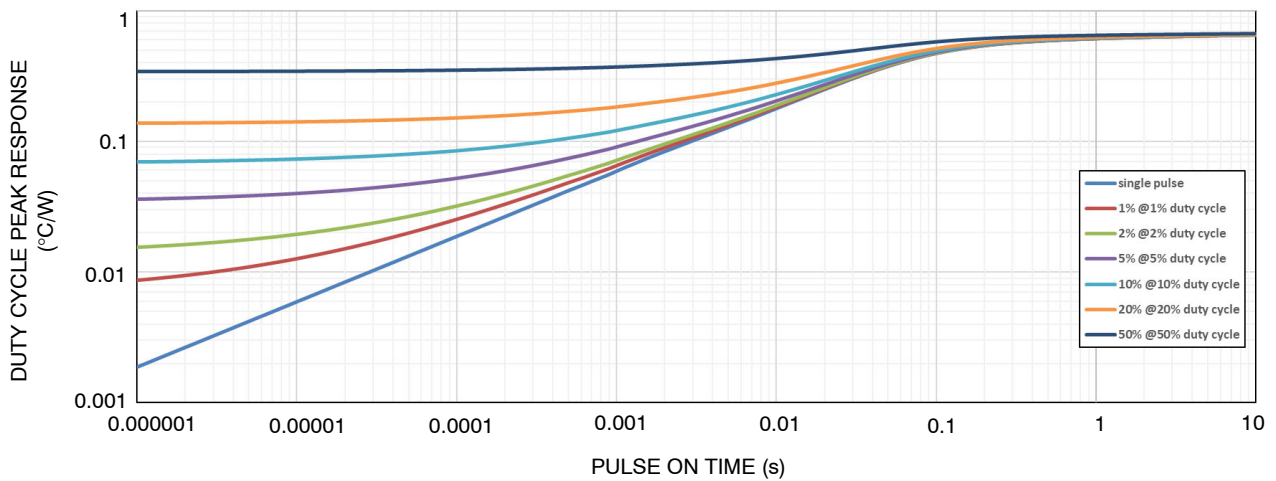

Figure 31. Transient Thermal Impedance (BOOST DIODE)

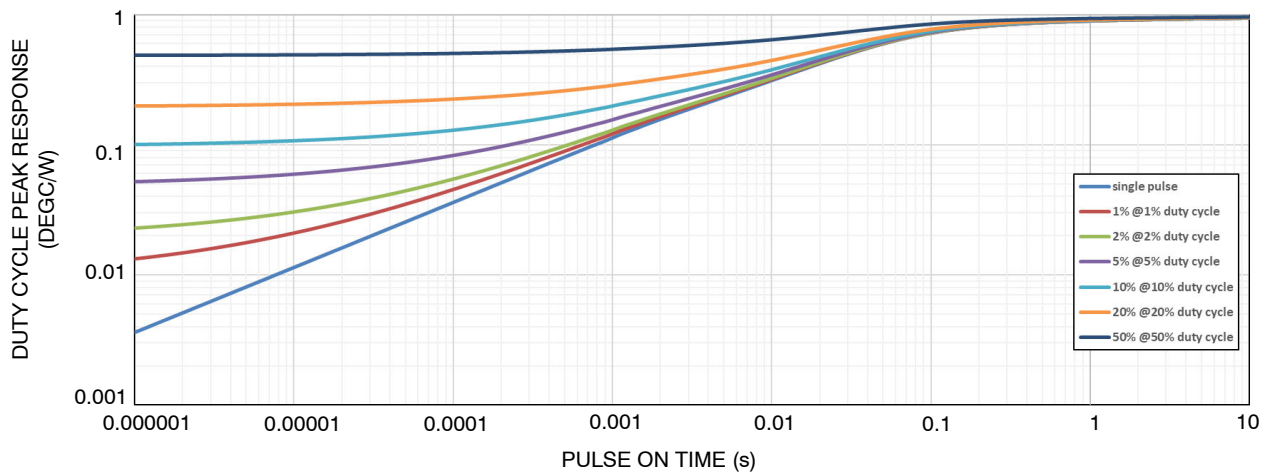

Figure 32. Transient Thermal Impedance (INVERSE DIODE)

NXH600B100H4Q2F2PG, NXH600B100H4Q2F2SG, NXH600B100H4Q2F2SG-R

ORDERING INFORMATION

Device Order Number	Marking	Package	Shipping
NXH600B100H4Q2F2SG, NXH600B100H4Q2F2SG-R	NXH600B100H4Q2F2SG, NXH600B100H4Q2F2SG-R	Q2BOOST - Case 180HE (Pb-Free and Halide-Free Solder Pins)	12 Units / Blister Tray
NXH600B100H4Q2F2PG	NXH600B100H4Q2F2PG	Q2BOOST - Case 180HF (Pb-Free and Halide-Free Press Fit Pins)	12 Units / Blister Tray

MECHANICAL CASE OUTLINE

PACKAGE DIMENSIONS

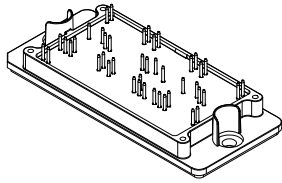

PIM44, 93x47 (SOLDER PIN)
CASE 180HE
ISSUE O

DATE 21 OCT 2021

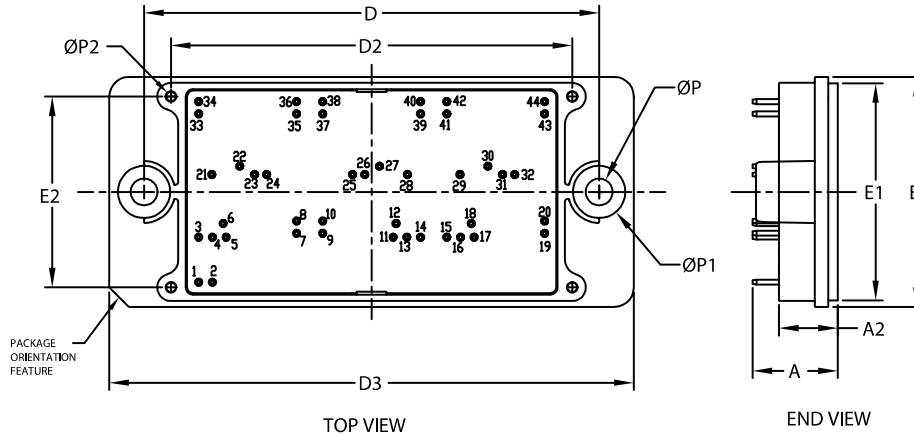

DIM	MILLIMETERS		
	MIN.	NOM.	MAX.
A	17.00	17.40	17.80
A2	11.70	12.00	12.30
A3	4.40	4.70	5.00
A4	16.40	16.70	17.00
b	0.95	1.00	1.05
D	92.90	93.00	93.10
D1	104.45	104.75	105.05
D2	81.80	82.00	82.20
D3	106.90	107.20	107.50
E	46.70	47.00	47.30
E1	44.10	44.40	44.70
E2	38.80	39.00	39.20
P	5.40	5.50	5.60
P1	10.60	10.70	10.80
P2	1.80	2.00	2.20

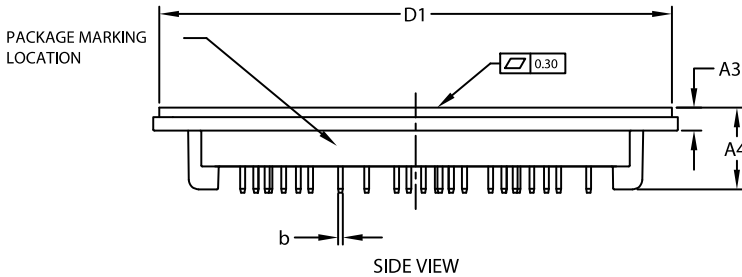

NOTES:

1. DIMENSIONING AND TOLERANCING PER ASME Y14.5M, 2009
2. CONTROLLING DIMENSION : MILLIMETERS
3. DIMENSIONS b AND b1 APPLY TO THE PLATED TERMINALS AND ARE MEASURED AT DIMENSION A1
4. PIN POSITION TOLERANCE IS $\pm 0.4\text{mm}$
5. PACKAGE MARKING IS LOCATED AS SHOWN ON THE SIDE OPPOSITE THE PACKAGE ORIENTATION FEATURES

NOTE 4

PIN	PIN POSITION		PIN	PIN POSITION	
	X	Y		X	Y
1	0.00	0.00	23	11.40	22.00
2	2.80	0.00	24	13.90	22.00
3	0.00	9.20	25	31.45	22.00
4	2.80	9.20	26	33.95	22.00
5	5.60	9.20	27	36.95	23.70
6	5.00	12.00	28	42.65	22.00
7	20.00	10.00	29	53.40	22.00
8	20.00	12.50	30	59.10	23.70
9	25.35	10.00	31	62.10	22.00
10	25.35	12.50	32	64.60	22.00
11	39.75	9.20	33	0.00	34.40
12	40.35	12.00	34	0.00	36.90
13	42.55	9.20	35	20.00	34.40
14	45.35	9.20	36	20.00	36.90
15	50.70	9.20	37	25.35	34.40
16	53.50	9.20	38	25.35	36.90
17	56.30	9.20	39	45.35	34.40
18	55.70	12.00	40	45.35	36.90
19	70.70	10.00	41	50.70	34.40
20	70.70	12.50	42	50.70	36.90
21	2.70	22.00	43	70.70	34.40
22	8.40	23.70	44	70.70	36.90

DOCUMENT NUMBER:	98AON39002H	Electronic versions are uncontrolled except when accessed directly from the Document Repository. Printed versions are uncontrolled except when stamped "CONTROLLED COPY" in red.
DESCRIPTION:	PIM44, 93x47 (SOLDER PIN)	PAGE 1 OF 2

onsemi and onsemi are trademarks of Semiconductor Components Industries, LLC dba onsemi or its subsidiaries in the United States and/or other countries. onsemi reserves the right to make changes without further notice to any products herein. onsemi makes no warranty, representation or guarantee regarding the suitability of its products for any particular purpose, nor does onsemi assume any liability arising out of the application or use of any product or circuit, and specifically disclaims any and all liability, including without limitation special, consequential or incidental damages. onsemi does not convey any license under its patent rights nor the rights of others.

MECHANICAL CASE OUTLINE

PACKAGE DIMENSIONS

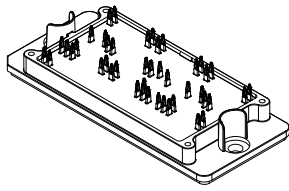

PIM44, 93x47 (PRESS FIT)
CASE 180HF
ISSUE O

DATE 26 OCT 2021

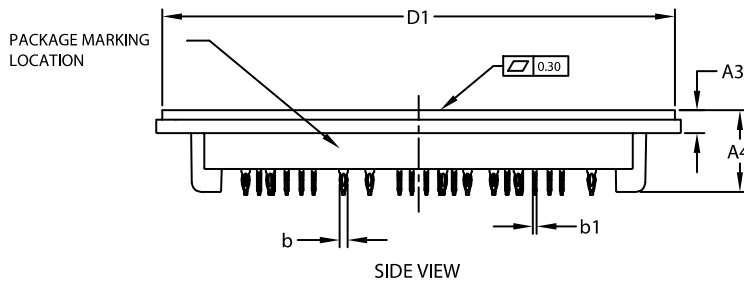
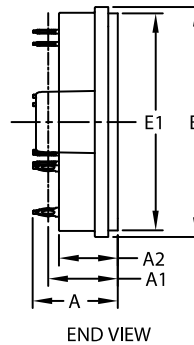
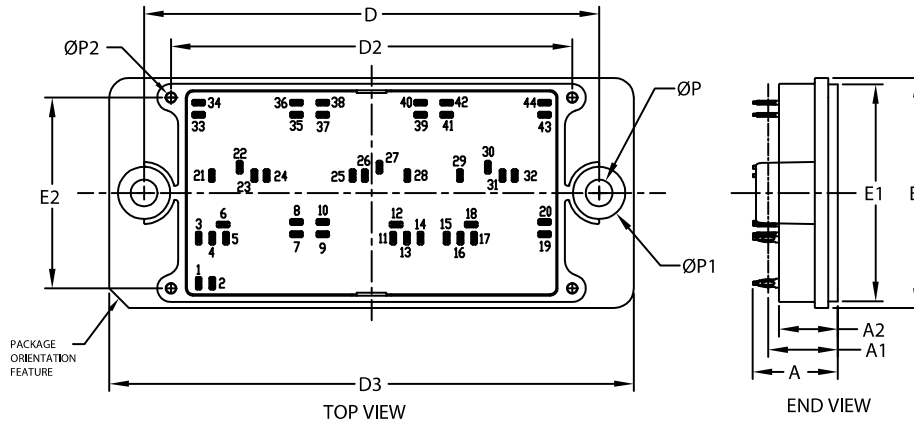

NOTES:

1. DIMENSIONING AND TOLERANCING PER ASME Y14.5M, 2009
2. CONTROLLING DIMENSION : MILLIMETERS
3. DIMENSIONS b AND b1 APPLY TO THE PLATED TERMINALS AND ARE MEASURED AT DIMENSION A1
4. PIN POSITION TOLERANCE IS $\pm 0.4\text{mm}$
5. PACKAGE MARKING IS LOCATED AS SHOWN ON THE SIDE OPPOSITE THE PACKAGE ORIENTATION FEATURES

DIM	MILLIMETERS		
	MIN.	NOM.	MAX.
A	16.90	17.30	17.70
A1	14.18(REF)		
A2	11.70	12.00	12.30
A3	4.40	4.70	5.00
A4	16.40	16.70	17.00
b	1.61	1.66	1.71
b1	0.75	0.80	0.85
D	92.90	93.00	93.10
D1	104.45	104.75	105.05
D2	81.80	82.00	82.20
D3	106.90	107.20	107.50
E	46.70	47.00	47.30
E1	44.10	44.40	44.70
E2	38.80	39.00	39.20
P	5.40	5.50	5.60
P1	10.60	10.70	10.80
P2	1.80	2.00	2.20

NOTE 4

PIN	PIN POSITION		PIN	PIN POSITION	
	X	Y		X	Y
1	0.00	0.00	23	11.40	22.00
2	2.80	0.00	24	13.90	22.00
3	0.00	9.20	25	31.45	22.00
4	2.80	9.20	26	33.95	22.00
5	5.60	9.20	27	36.95	23.70
6	5.00	12.00	28	42.65	22.00
7	20.00	10.00	29	53.40	22.00
8	20.00	12.50	30	59.10	23.70
9	25.35	10.00	31	62.10	22.00
10	25.35	12.50	32	64.60	22.00
11	39.75	9.20	33	0.00	34.40
12	40.35	12.00	34	0.00	36.90
13	42.55	9.20	35	20.00	34.40
14	45.35	9.20	36	20.00	36.90
15	50.70	9.20	37	25.35	34.40
16	53.50	9.20	38	25.35	36.90
17	56.30	9.20	39	45.35	34.40
18	55.70	12.00	40	45.35	36.90
19	70.70	10.00	41	50.70	34.40
20	70.70	12.50	42	50.70	36.90
21	2.70	22.00	43	70.70	34.40
22	8.40	23.70	44	70.70	36.90

DOCUMENT NUMBER:	98AON39004H	Electronic versions are uncontrolled except when accessed directly from the Document Repository. Printed versions are uncontrolled except when stamped "CONTROLLED COPY" in red.
DESCRIPTION:	PIM44, 93x47 (PRESS FIT)	PAGE 1 OF 2

onsemi and ONSEMI are trademarks of Semiconductor Components Industries, LLC dba onsemi or its subsidiaries in the United States and/or other countries. onsemi reserves the right to make changes without further notice to any products herein. onsemi makes no warranty, representation or guarantee regarding the suitability of its products for any particular purpose, nor does onsemi assume any liability arising out of the application or use of any product or circuit, and specifically disclaims any and all liability, including without limitation special, consequential or incidental damages. onsemi does not convey any license under its patent rights nor the rights of others.

MECHANICAL CASE OUTLINE
PACKAGE DIMENSIONS



PIM44, 93x47 (PRESS FIT)
CASE 180HF
ISSUE O

DATE 26 OCT 2021

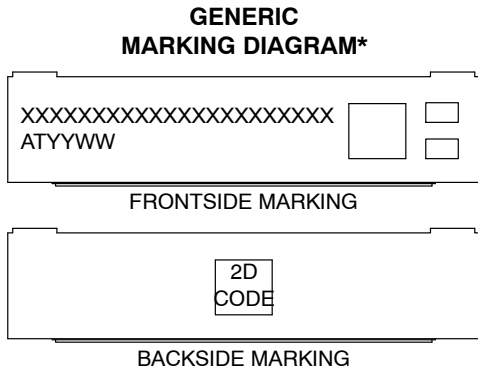

XXXXX = Specific Device Code
 AT = Assembly & Test Site Code
 YYWW = Year and Work Week Code

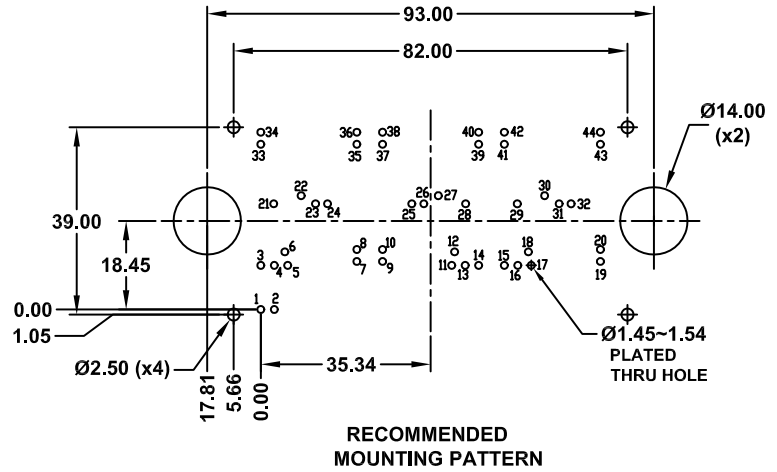

*This information is generic. Please refer to device data sheet for actual part marking. Pb-Free indicator, "G" or microdot "▪", may or may not be present. Some products may not follow the Generic Marking.

DOCUMENT NUMBER:	98AON39004H	Electronic versions are uncontrolled except when accessed directly from the Document Repository. Printed versions are uncontrolled except when stamped "CONTROLLED COPY" in red.
DESCRIPTION:	PIM44, 93x47 (PRESS FIT)	PAGE 2 OF 2

onsemi and onsemi are trademarks of Semiconductor Components Industries, LLC dba onsemi or its subsidiaries in the United States and/or other countries. onsemi reserves the right to make changes without further notice to any products herein. onsemi makes no warranty, representation or guarantee regarding the suitability of its products for any particular purpose, nor does onsemi assume any liability arising out of the application or use of any product or circuit, and specifically disclaims any and all liability, including without limitation special, consequential or incidental damages. onsemi does not convey any license under its patent rights nor the rights of others.

www.onsemi.com

onsemi, **Onsemi**, and other names, marks, and brands are registered and/or common law trademarks of Semiconductor Components Industries, LLC dba "**onsemi**" or its affiliates and/or subsidiaries in the United States and/or other countries. **onsemi** owns the rights to a number of patents, trademarks, copyrights, trade secrets, and other intellectual property. A listing of **onsemi**'s product/patent coverage may be accessed at www.onsemi.com/site/pdf/Patent-Marking.pdf. **onsemi** reserves the right to make changes at any time to any products or information herein, without notice. The information herein is provided "as-is" and **onsemi** makes no warranty, representation or guarantee regarding the accuracy of the information, product features, availability, functionality, or suitability of its products for any particular purpose, nor does **onsemi** assume any liability arising out of the application or use of any product or circuit, and specifically disclaims any and all liability, including without limitation special, consequential or incidental damages. Buyer is responsible for its products and applications using **onsemi** products, including compliance with all laws, regulations and safety requirements or standards, regardless of any support or applications information provided by **onsemi**. "Typical" parameters which may be provided in **onsemi** data sheets and/or specifications can and do vary in different applications and actual performance may vary over time. All operating parameters, including "Typicals" must be validated for each customer application by customer's technical experts. **onsemi** does not convey any license under any of its intellectual property rights nor the rights of others. **onsemi** products are not designed, intended, or authorized for use as a critical component in life support systems or any FDA Class 3 medical devices or medical devices with a same or similar classification in a foreign jurisdiction or any devices intended for implantation in the human body. Should Buyer purchase or use **onsemi** products for any such unintended or unauthorized application, Buyer shall indemnify and hold **onsemi** and its officers, employees, subsidiaries, affiliates, and distributors harmless against all claims, costs, damages, and expenses, and reasonable attorney fees arising out of, directly or indirectly, any claim of personal injury or death associated with such unintended or unauthorized use, even if such claim alleges that **onsemi** was negligent regarding the design or manufacture of the part. **onsemi** is an Equal Opportunity/Affirmative Action Employer. This literature is subject to all applicable copyright laws and is not for resale in any manner.

ADDITIONAL INFORMATION

TECHNICAL PUBLICATIONS:

Technical Library: www.onsemi.com/design/resources/technical-documentation
onsemi Website: www.onsemi.com

ONLINE SUPPORT: www.onsemi.com/support

For additional information, please contact your local Sales Representative at www.onsemi.com/support/sales