



# American Opto Plus LED Corp.

## L955SRIRC-TR

3.5 x 2.8 x 1.9 mm Bi-Color PLCC-4

### PACKAGE OUTLINES:

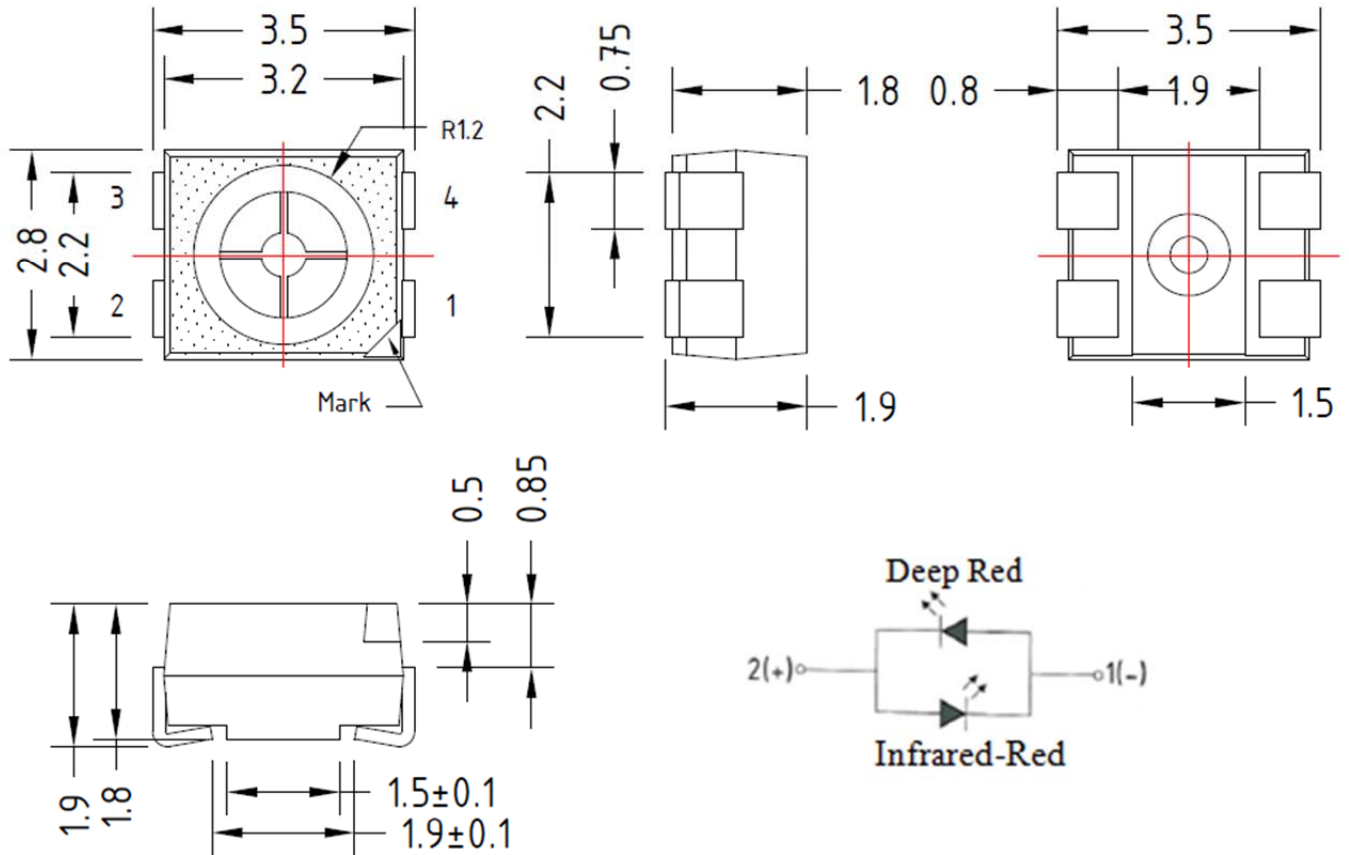

Item	Materials
Package	Heat-Resistant Polymer
Encapsulating Resin	Silicone
Electrodes	Ag Plating Copper Alloy

#### NOTES:

1. All dimensions are in millimeters (inches);
2. Electrical Connection between all Cathodes is Recommended



# American Opto Plus LED Corp.

## L955SRIRC-TR

3.5 x 2.8 x 1.9 mm Bi-Color PLCC-4

### ABSOLUTE MAXIMUM RATINGS

(Ta=25°C)

Item	Symbol	Max Rating		Unit
		SR	IR	
DC Forward Current	I <sub>F</sub>	50	50	mA
Peak Pulse Forward Current *	I <sub>PF</sub>	100	--	mA
Surge Current (t=10 μs) *	I <sub>FP</sub>	--	1	A
Power Dissipation Single Color	P <sub>D</sub>	120	85	mW
Reverse Voltage	V <sub>R</sub>	5	5	V
Operating Temperature	T <sub>OPR</sub>	-30~+85		°C
Storage Temperature	T <sub>STG</sub>	-40~+100		°C
Solder Temperature	T <sub>SOL</sub>	265°C for 10 sec Hand soldering: 350°C for 3sec		

\*Pulse width ≤ 100 μs, Duty Ratio ≤ 1%

### OPTICAL-ELECTRICAL CHARACTERISTICS

(Ta=25°C)

Parameter	Symbol	Test Condition	Super Red			Infrared			Unit
			Min	Typ	Max	Min	Typ	Max	
Forward Voltage	V <sub>F</sub>	I <sub>F</sub> =20mA	2.0	2.1	2.4	--	1.5	1.7	V
Reverse Current	I <sub>R</sub>	V <sub>R</sub> =5V	--	--	10	--	--	10	μA
Peak Wavelength	λ <sub>p</sub>	I <sub>F</sub> =20mA	650	660	670	840	850	860	nm
Spectral Half Width	Δλ <sub>1/2</sub>	I <sub>F</sub> =20mA	--	16	--	--	35	--	nm
Radiant Intensity	E <sub>e</sub>	I <sub>F</sub> =20mA	--	45	--	--	30	--	mW/sr

Notes: Luminous intensity tolerance is ±10%



American Opto Plus LED Corp.

L955SRIRC-TR

3.5 x 2.8 x 1.9 mm Bi-Color PLCC-4

## Radiation Pattern

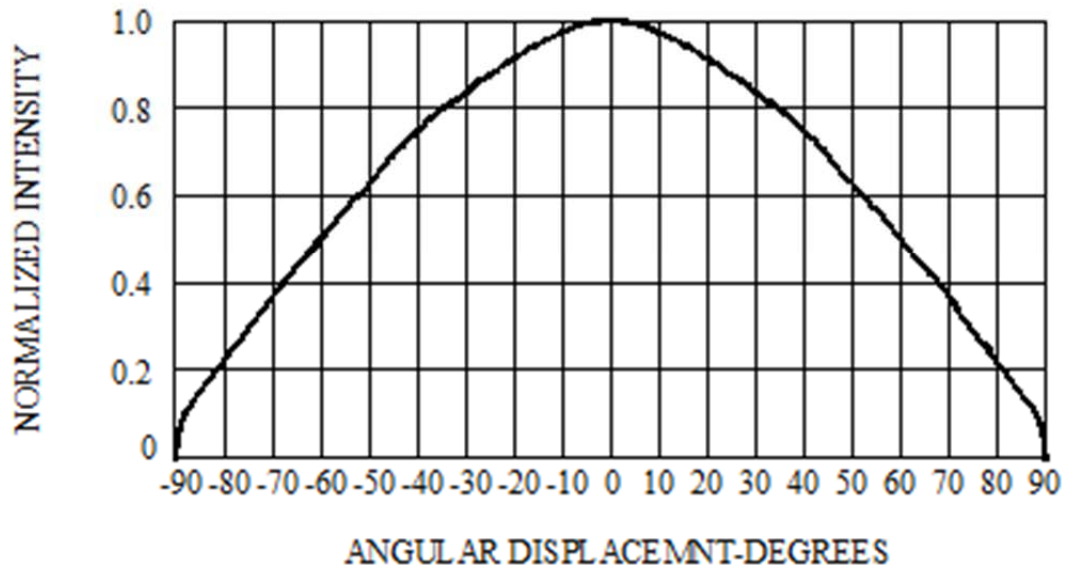

## Recommended Soldering Pad Pattern

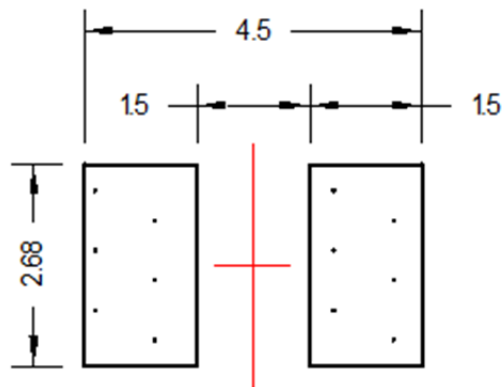

(Unit:mm)

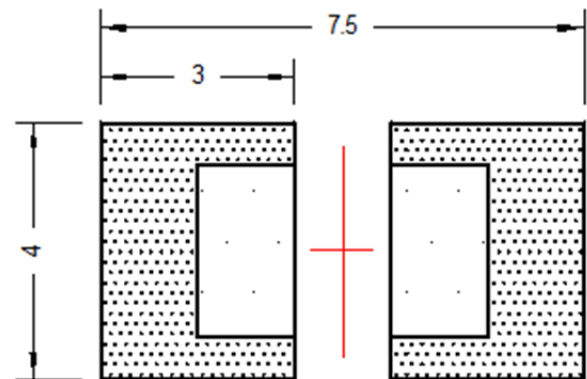

 Solder resist (Unit:mm)



# American Opto Plus LED Corp.

## L955SRIRC-TR

3.5 x 2.8 x 1.9 mm Bi-Color PLCC-4

### Electrical-Optical Characteristics

Forward Current vs. Forward Voltage

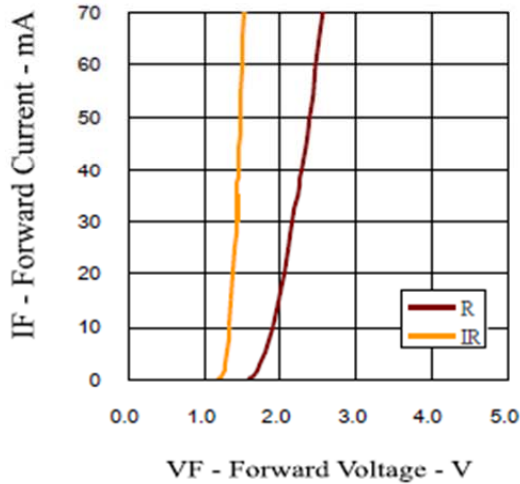

Relative Intensity vs. Forward Current

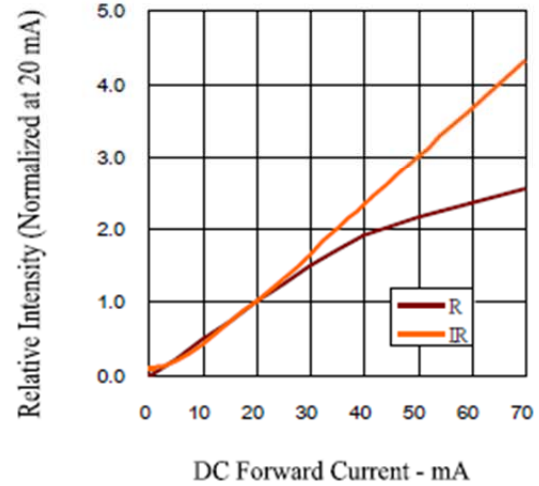

Forward Current vs. Ambient Temperature

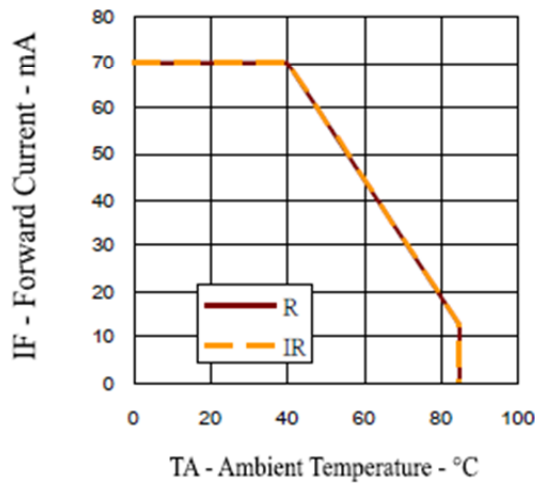

Relative Intensity vs. Wavelength

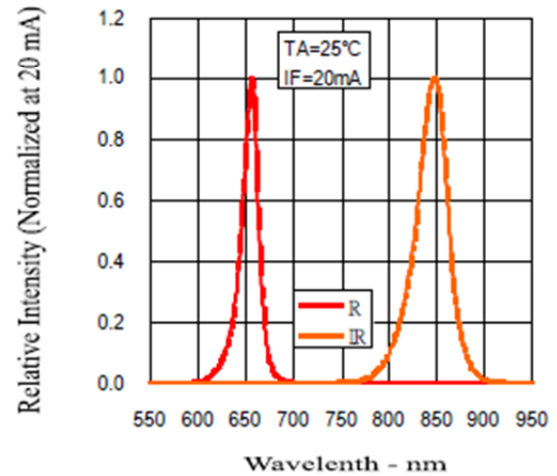



# American Opto Plus LED Corp.

## L955SRIRC-TR

3.5 x 2.8 x 1.9 mm Bi-Color PLCC-4

### Soldering Conditions

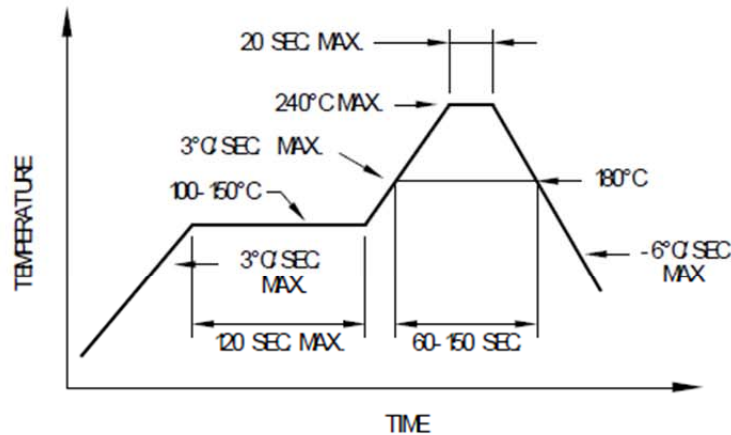

Recommended reflow soldering profile

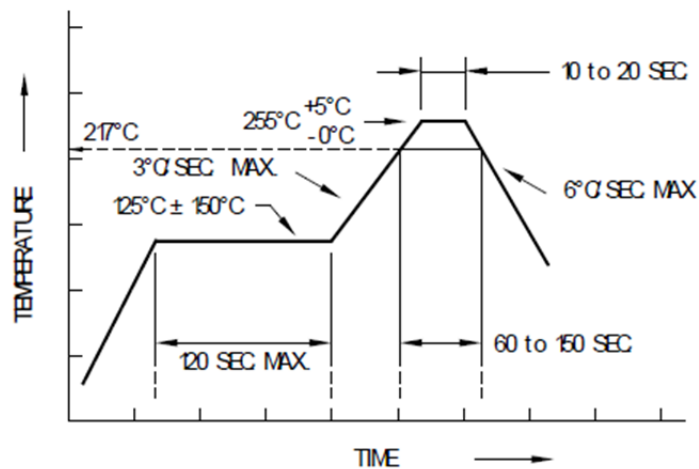

Recommended Pb-free reflow soldering profile

- Repairing should not be done after the LEDs have been soldered. When repairing is unavoidable, a double-head soldering iron should be used. It should be confirmed beforehand whether the characteristics of the LEDs will or will not be damaged by repairing.
- Reflow soldering should not be done more than two times.
- When soldering, do not put stress on the LEDs during heating.
- After soldering, do not warp the circuit board.



# American Opto Plus LED Corp.

## L955SRIRC-TR

3.5 x 2.8 x 1.9 mm Bi-Color PLCC-4

### Tape Dimension

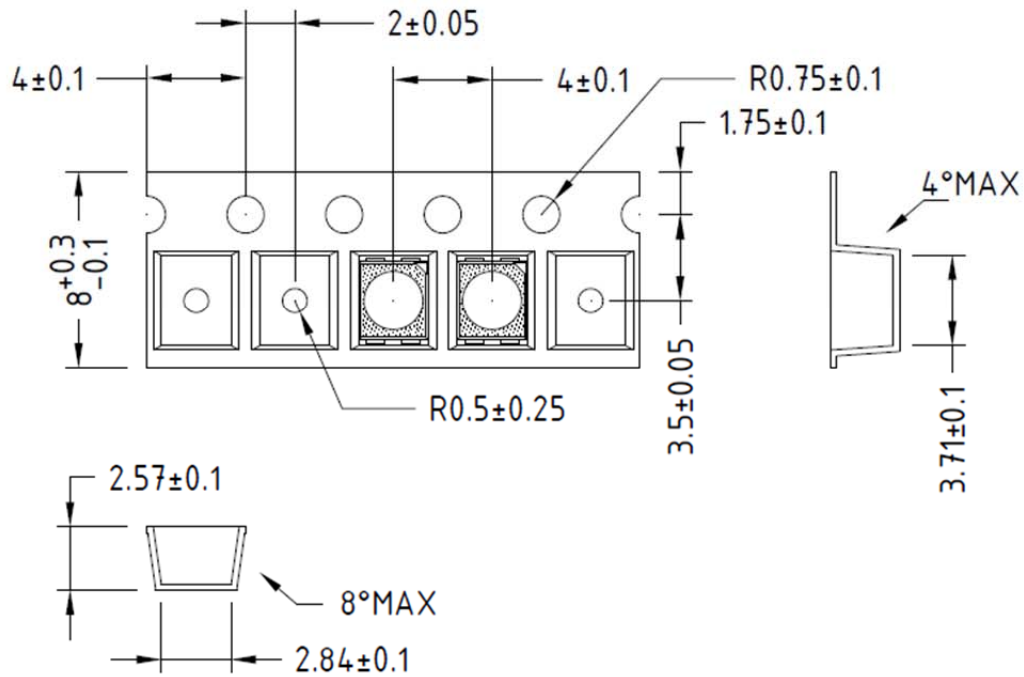

### Tape Leader and Trailer Dimension

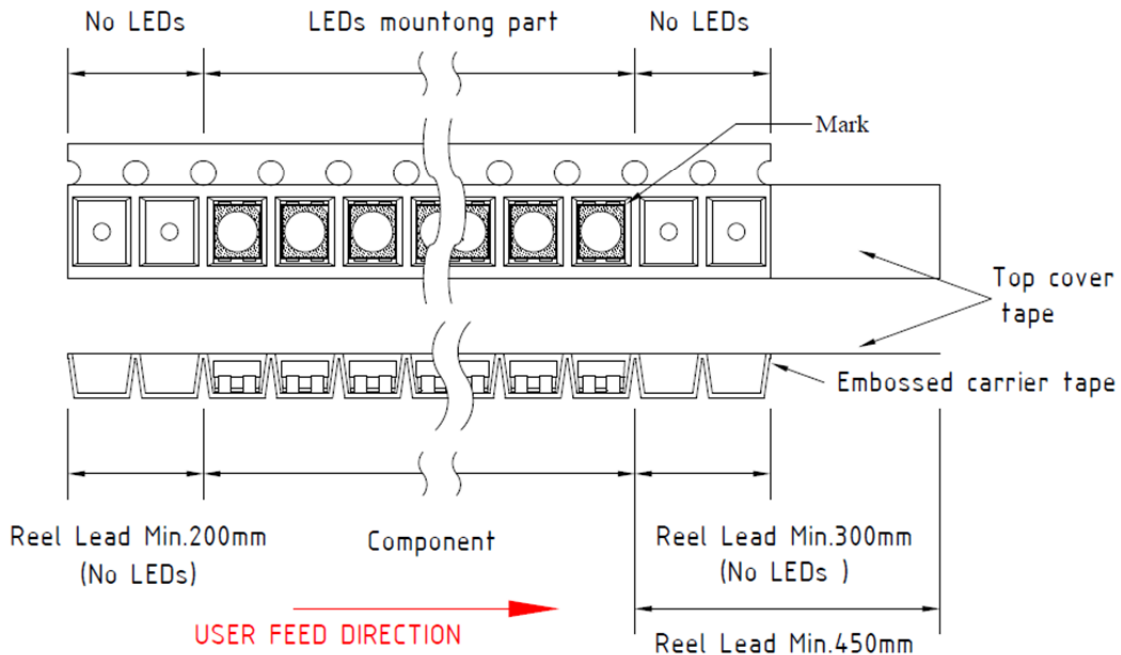

Note: 2000 pcs / reel



American Opto Plus LED Corp.

L955SRIRC-TR

3.5 x 2.8 x 1.9 mm Bi-Color PLCC-4

## Reel dimension

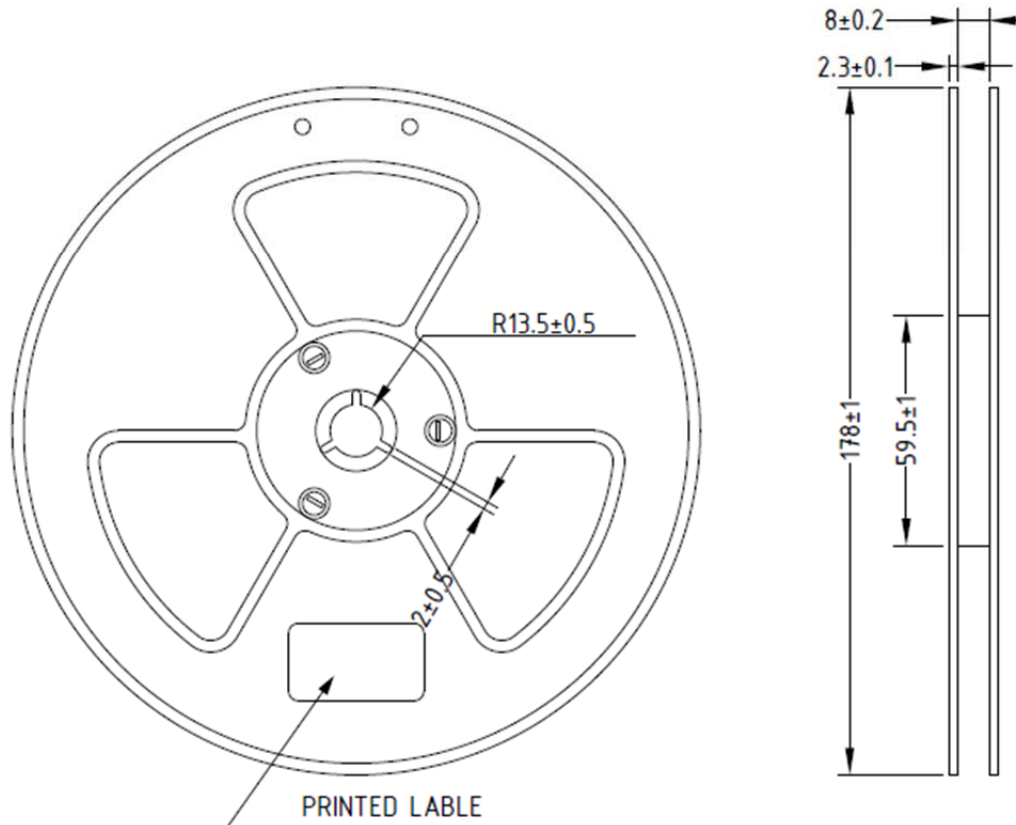

Note: Baking is required under the following conditions:

The pack has been opened for more than four weeks.

Baking recommended conditions:

$60 \pm 5$  °C for 20 hours.