

Encapsulated Quarter-Brick 100-Watt Isolated DC-DC Converter



| Output Voltage (V) | Output Current (A) | Input Voltage (V) |
|--------------------|--------------------|-------------------|
| 5 | 20 | 110 |
| 12 | 8.3 | 110 |
| 24 | 4.2 | 110 |

Optimized for harsh environments in industrial/railway applications, the IRQ DC-DC converter series offer regulated outputs in an industry-standard quarter brick fully encased package.

FEATURES

- DC input range: 57.6-160V (Covers both 96V and 110V input range)
- Encapsulated circuitry for optimal thermal/vibration performance
- Regulation: $\pm 0.3\%$ from no load to full load
- High Efficiency
- Maximum baseplate operating temperature: 100°C, full load
- Over-current & Over-temperature protection
- Diode rectifier topology
- Stable no-load operation
- Support Pre-Bias startup

SAFETY FEATURES

- Reinforced insulation
- 3000Vrms input to output isolation
- EN 50155
- UL 60950-1
- CAN/CSA-C22.2 No. 60950-1
- IEC 60950-1
- RoHS compliant

PRODUCT OVERVIEW

The IRQ series regulated converter module deliver a 5V, 12V or 24V output @ $V_{in} = 57.6 - 160$ Vdc in an industry standard quarter brick fully encased package at astonishing efficiency. The fully isolated (3000Vrms) IRQ series accept a 57.6 to 160 Volt DC input voltage range with a reinforced insulation system. Typical applications include industrial, railway and transportation applications.

The IRQ's diode-rectifier topology and fixed frequency operations means excellent efficiencies. A wealth of electronic protection features include input under voltage lockout, output over voltage lockout protection, output current limit, short circuit hiccup, V_{out} overshoot, and over temperature shutdown. Available options include various pin lengths and flanged baseplate. The IRQ series is designed to meet all UL and IEC emissions, safety, and flammability certifications.

Slotted / Flanged Baseplate
"V" Option Pins / Pinout
Pin Dia : 0.080

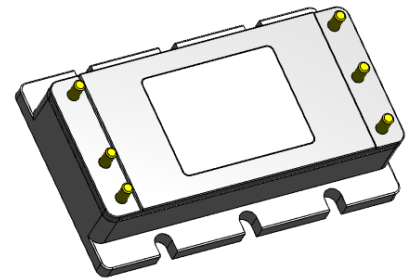

Slotted / Flanged Baseplate
DOSA Pins / Pinout
Pin Dia : 0.040 / 0.060

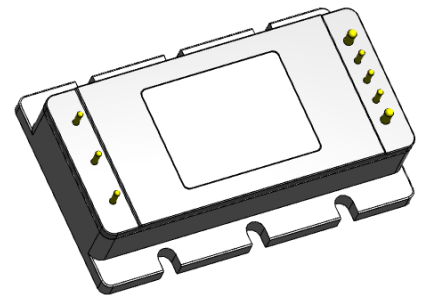

Standard Baseplate
DOSA Pins / Pinout
Pin Dia : 0.040 / 0.060

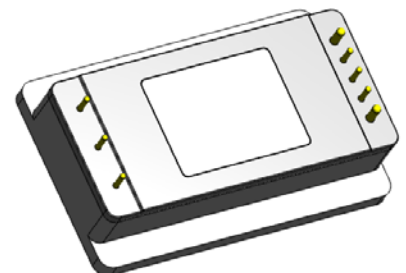

For full details go to
www.murata-ps.com/rohs



| PERFORMANCE SPECIFICATIONS SUMMARY AND ORDERING GUIDE ① ② | | | | | | | | | | | | | |
|---|----------|---------------|-----------------|------------------------|------|-------------------|-------|--------------|-----------|-------------------|--------------------|------------|-------|
| Root Model ① | Output | | | | | | | Input | | | | Efficiency | |
| | VOUT (V) | IOUT (A, max) | Total Power (W) | Ripple & Noise (mVp-p) | | Regulation (max.) | | VIN Nom. (V) | Range (V) | IIN, no load (mA) | IIN, full load (A) | Min. | Typ. |
| | | | | Typ. | Max. | Line | Load | | | | | | |
| IRQ-5/20-T110 | 5 | 20 | 100 | 80 | 150 | ±0.2% | ±0.3% | 110 | 57.6-160 | 150 | 2.06 | 83.0% | 85.5% |
| IRQ-12/8.3-T110 | 12 | 8.3 | 100 | 50 | 120 | ±0.6% | ±0.5% | 110 | 57.6-160 | 50 | 2.50 | 87.0% | 87.4% |
| IRQ-24/4.2-T110 | 24 | 4.2 | 100 | 100 | 240 | ±0.3% | ±0.3% | 110 | 57.6-160 | 20 | 2.50 | 86.5% | 88.2% |

① Please refer to the part number structure for additional options and complete ordering part numbers.

② All specifications are at nominal line voltage and full load, +25 °C. Unless otherwise noted. See detailed specifications. Output capacitors are 1 µF ceramic in parallel with 10 µF electrolytic. I/O caps are necessary for our test equipment and may not be needed for your application.

NOTE: Please see [Page 30](#) for the Product Status information.

Part Number Structure

IR X - Vout / Iout - Input Voltage N V F - C

- Industrial-Railway** (IR)
- Package** (X)
 - Q = Quarter Brick
- Nominal Output Voltage** (Vout / Iout)
 - 5 = 5Vout
 - 12 = 12Vout
 - 24 = 24Vout
- Maximum Rated Output Current** (Iout)
 - Amps
- Input Voltage Range** (Input Voltage)
 - T110 = 57.6 - 160V (110V Nominal)
- On/Off Control Logic** (N)
 - N = Negative Logic (Standard with Pin Option #2)
 - P = Positive Logic (Standard with Pin Option #1-V)
- Pin Options** (V)
 - V = Option #1, V Option Pins/Pinout
 - Please see mechanical drawings for V Option
 - Blank = Option #2 (DOSA)
- Package/Cooling Configuration** (F)
 - Blank = Standard Baseplate (Not available with Pin Option #1 V, Please see mechanical drawings for details)
 - F = Slotted/Flanged Baseplate (Please see mechanical drawings for details)
- RoHS-Compliant** (C)

Examples: IRQ-5/20-T110N-C stands for Industrial Rail Quarter Brick, 5Vout @ 20A, 57.6V - 160Vin, Negative Logic, Option #2 Pin Option, Standard Baseplate, RoHS Compliant. IRQ-5/20-T110PVF-C stands for Industrial Rail Quarter Brick, 5Vout @ 20A, 57.6V - 160Vin, Positive Logic, V Pin option with Slotted / Flanged Baseplate, RoHS Compliant.

Note: Please see mechanical drawings for details. Special order applies to Positive Logic version. Some model number combinations may not be available. See website or contact your local Murata sales representative.

IRQ SERIES FUNCTIONAL SPECIFICATIONS

| ABSOLUTE MAXIMUM RATINGS | Conditions | Minimum | Typical/Nominal | Maximum | Units |
|--|---|---------|-----------------|---------|-------|
| Input Voltage, Continuous | | 0 | | 160 | Vdc |
| Input Voltage, Transient | 100 mS max. duration | | | 170 | Vdc |
| Isolation Voltage(Test voltage) | Input to output | | | 3000 | Vrms |
| | Input to Baseplate | | | 1500 | Vrms |
| | Output to Baseplate | | | 1500 | Vrms |
| On/Off Remote Control | Referred to -Vin | 0 | | 15 | Vdc |
| Operating Temperature Range | Ambient Temperature | -40 | | 85 | °C |
| Storage Temperature Range | Baseplate Temperature | -55 | | 125 | °C |
| Absolute Baseplate Temperature | | | | 100 | °C |
| Absolute maximums are stress ratings. Exposure of devices to greater than any of these conditions may adversely affect long-term reliability. Proper operation under conditions other than those listed in the Performance/Functional Specifications Table is not implied nor recommended. | | | | | |
| INPUT | | | | | |
| Operating Input Voltage Range | | 57.6 | | 160 | Vdc |
| Turn-on Voltage Threshold | | 52 | 54.5 | 57 | Vdc |
| Turn-off Voltage Threshold | | 50 | 52 | 56 | Vdc |
| FEATURES and OPTIONS | | | | | |
| Conditions | | | | | |
| Minimum | | | | | |
| Typical/Nominal | | | | | |
| Maximum | | | | | |
| Units | | | | | |
| Primary On/Off control (designed to be driving with an open collector logic, Voltages referenced to -Vin) | | | | | |
| "P" suffix: Standard on the V Option #1, V Option Pins/Pinout | | | | | |
| Positive Logic, ON state | ON = pin open or external voltage | 3.5 | | 15 | V |
| Positive Logic, OFF state | OFF = ground pin or external voltage | 0 | | 1 | V |
| Control Current | open collector/drain | | 1 | 2 | mA |
| "N" suffix: Standard on the Option #2, DOSA Pin Option | | | | | |
| Negative Logic, ON state | ON = ground pin or external voltage | -0.1 | | 0.8 | V |
| Negative Logic, OFF state | OFF = pin open or external voltage | 2.5 | | 15 | V |
| Control Current | open collector/drain | | 1 | 2 | mA |
| Remote Sense Compliance | Sense pins connected externally to respective Vout pins | | 5 | | % |
| ENVIRONMENTAL | | | | | |
| Operating Ambient Temperature | Ambient Temperature | -40 | | 85 | °C |
| | Baseplate Temperature | -40 | | 110 | °C |
| Storage Temperature | | -55 | | 125 | °C |
| Semiconductor Junction Temperature | | | | 125 | °C |
| Thermal Protection | Average PCB Temperature | | 125 | | °C |
| Thermal Protection Restart Hysteresis | | | | | °C |
| Electromagnetic Interference | External filter required; see Emissions performance test. | | B | | Class |
| Conducted, EN55022/CISPR22 | | | | | |
| RoHS rating | | | RoHS | | |
| GENERAL and SAFETY | | | | | |

IRQ SERIES FUNCTIONAL SPECIFICATIONS

| | | | | | |
|------------------------------------|--|----------------|------------------------|----------------|--------------|
| Insulation Safety Rating | | | Reinforced | | |
| Isolation Resistance | | 10 | | | MΩ |
| Isolation Capacitance | | | | 500 | pF |
| Safety | Certified to UL-60950-1, CSA-C22.2 No.60950-1, IEC60950-1, 2nd edition | | Yes | | |
| MECHANICAL | Conditions | Minimum | Typical/Nominal | Maximum | Units |
| Through Hole Pin Diameter | Standard:Option#2 | | 0.06 & 0.04 | | Inches |
| | | | 1.524 & 1.016 | | mm |
| | Option#1 | | 0.08 | | Inches |
| | | | 2.032 | | mm |
| Through Hole Pin Material | | | Copper alloy | | |
| TH Pin Plating Metal and Thickness | Nickel subplate | | 98.4-299 | | μ-inches |
| | Gold overplate | | 4.7-19.6 | | μ-inches |

FUNCTIONAL SPECIFICATIONS (IRQ-5/20-T110)

| INPUT | Conditions | Minimum | Typical/Nominal | Maximum | Units |
|---|--|---------|-----------------|---------|----------------------|
| Input current | | | | | |
| Full Load Conditions | Vin = nominal | | 1.06 | 1.11 | A |
| Low Line input current | Vin = minimum | | 2.01 | 2.06 | A |
| Inrush Transient | Vin = 110v | | 0.1 | 0.2 | A ² -Sec. |
| Short Circuit input current | | | 0.1 | 0.2 | A |
| No Load input current | Iout = minimum, unit=ON | | 50 | 150 | mA |
| Shut-Down input current (Off, UV, OT) | | | 15 | 30 | mA |
| Back Ripple Current | Measured at the input of module with a simulated source impedance of 12μH, 220μF, 450V, across source, 33μF, 250V external capacitors across input pins. | | | 2000 | mAp-p |
| Internal Filter Type/Value | | | Pi | | |
| Recommended Input fuse | | | | 5 | A |
| OUTPUT | | | | | |
| Total Output Power | | 0 | 100 | 101 | W |
| Voltage | | | | | |
| Setting Accuracy | At 100% load, no trim, all conditions | 4.95 | 5 | 5.05 | Vdc |
| Output Adjust Range | | 4.950 | | 5.050 | Vdc |
| Overvoltage Protection | See technical notes for details | 6 | 6.3 | 6.5 | Vdc |
| Current | | | | | |
| Output Current Range | | 0 | 20 | 20 | A |
| Minimum Load | | | 0 | | |
| Current Limit Inception | cold condition | 22 | 25 | 30 | A |
| Short Circuit | | | | | |
| Short Circuit Current | Hiccup technique - Auto recovery within 1.25% of Vout | | 2.0 | 4.0 | A |
| Short Circuit Duration (remove short for recovery) | Output shorted to ground, no damage | | Continuous | | |
| Short circuit protection method | Hiccup current limiting | | Non-latching | | |
| Regulation | | | | | |
| Line Regulation | Vin = 57.6-160, Vout = nom., full load | | | ±0.2 | % |
| Load Regulation | Iout = min. to max., Vin = nom. | | | ±0.3 | % |
| Ripple and Noise | 20 MHz BW, Cout = 1μF | | 80 | 150 | mV pk-pk |
| | paralleled with 10μF | | | | |
| Temperature Coefficient | At all outputs | | 0.02 | | % of Vnom./°C |
| Maximum Output Capacitance | (Loads : CR mode) | | | 3300 | μF |
| | (Loads : CC mode) | | | 3300 | μF |
| GENERAL and SAFETY | | | | | |
| Efficiency | Vin=110V, full load | 83 | 85.5 | | % |

FUNCTIONAL SPECIFICATIONS (IRQ-5/20-T110)

| | | | | | |
|-------------------------------------|---|----------------|------------------------|----------------|-------------------------|
| Isolation Resistance | | 10 | | | MΩ |
| Isolation Capacitance | | | | 500 | pF |
| Calculated MTBF | Per Telcordia SR-332, Issue 2, Method 1, Class 1, Ground Fixed, Tcase=+25°C | | 1800 | | Hours x 10 ³ |
| DYNAMIC CHARACTERISTICS | | | | | |
| Switching Frequency | | | 200 | | KHz |
| Turn On Time | | | | | |
| Rise time | 10% Vout to 90% Vout | | 15 | 30 | mS |
| Delay time | Vin on to 10% Vout | | 20 | 30 | mS |
| Dynamic Load Response | 50-75-50%, 1A/us, within 1% of Vout | | | 50 | μSec |
| Dynamic Load Peak Deviation | same as above | | ±100 | ±300 | mV |
| MECHANICAL | Conditions | Minimum | Typical/Nominal | Maximum | Units |
| Outline Dimensions (with baseplate) | | | 2.28x 1.45 x 0.5 | | Inches |
| | | | 57.91x36.83x 12.7 | | mm |
| Weight (with baseplate) | | | 2.23 | | Ounces |
| | | | 63.6 | | Grams |

PERFORMANCE DATA (IRQ-5/20-T110)

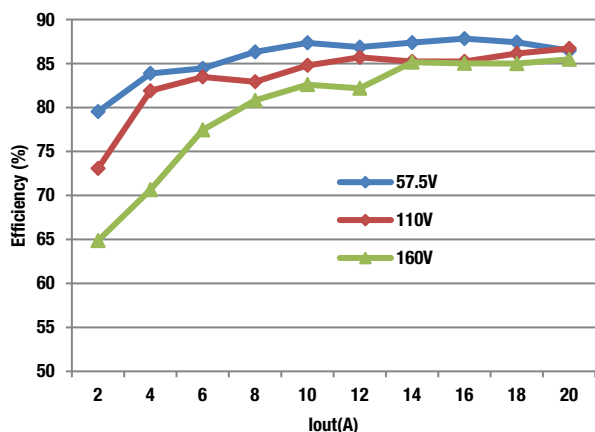

Efficiency vs. Load Current

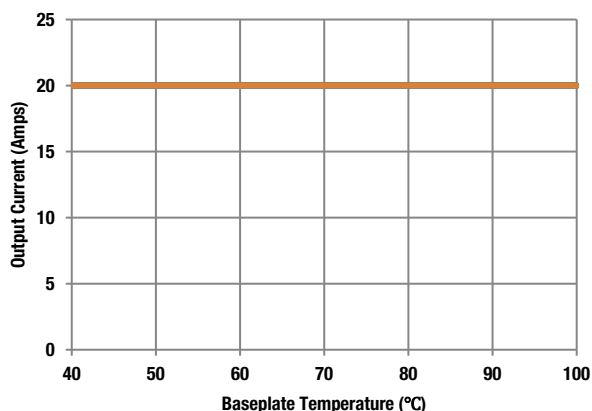

Thermal Derating vs. Baseplate temperature

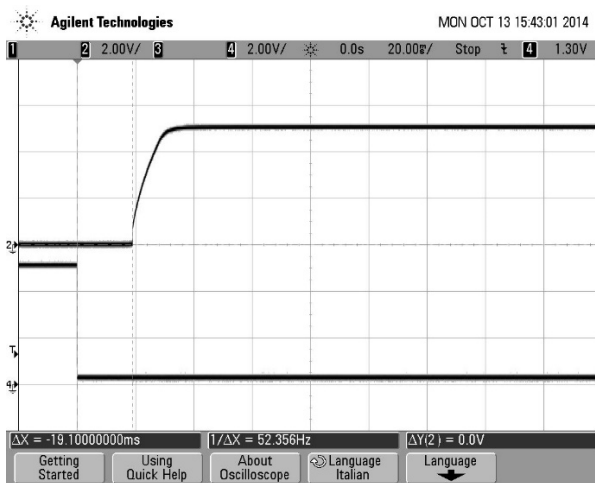

Turn-on transient at zero load current
(20 mS/div, Top Trace: Vout, 2V/div; Bottom Trace: ON/OFF, 2V/div)

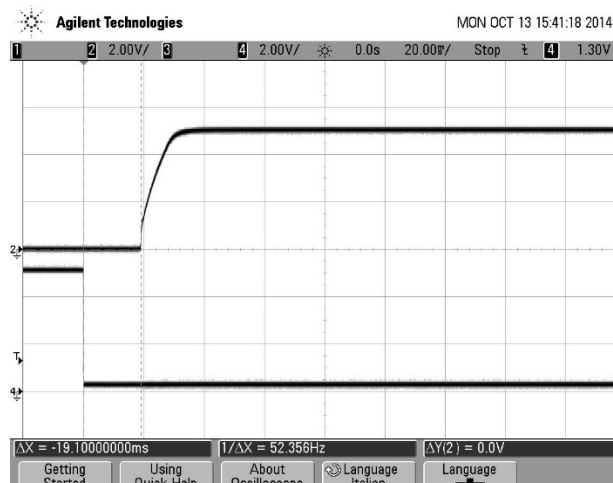

Turn-on transient at full load current
(20 mS/div, Top Trace: Vout, 2V/div; Bottom Trace: ON/OFF, 2V/div)

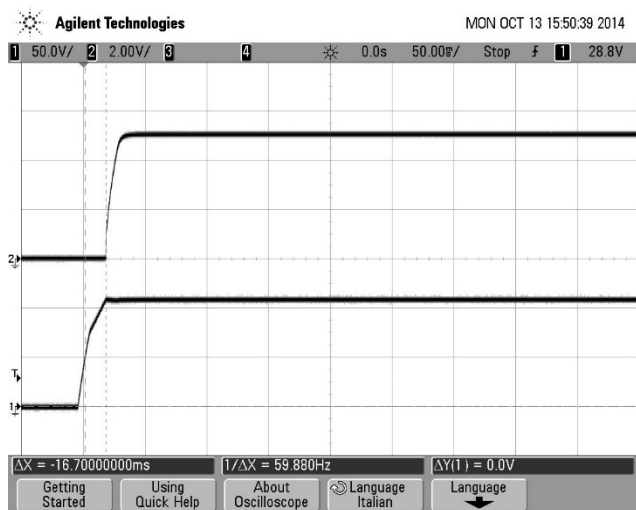

Turn-on transient at zero load current
(50 mS/div, Top Trace: Vout, 2V/div; Bottom Trace: Vin, 50V/div)

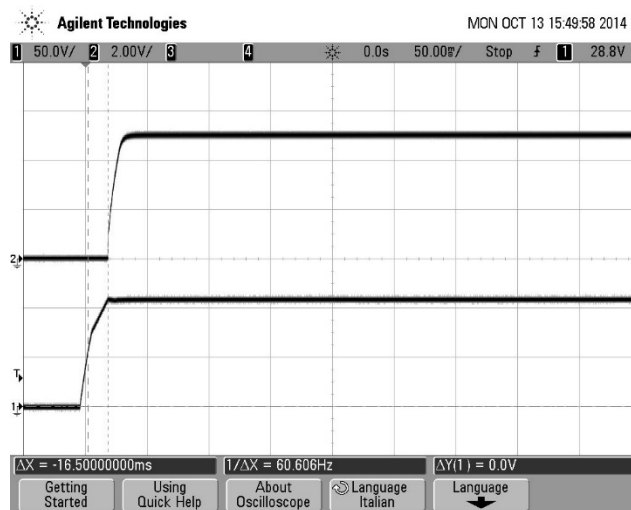

Turn-on transient at full load current
(50 mS/div, Top Trace: Vout, 2V/div; Bottom Trace: Vin, 50V/div)

PERFORMANCE DATA (IRQ-5/20-T110)

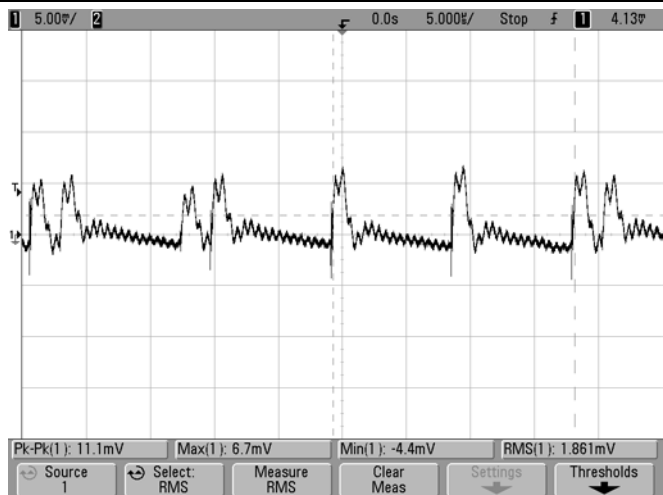

Ripple and Noise @25°C

(Vin = 110V, Vout = nom., Iout= 0, Cloud = 0, ScopeBW = 20MHz, 5µS/div)

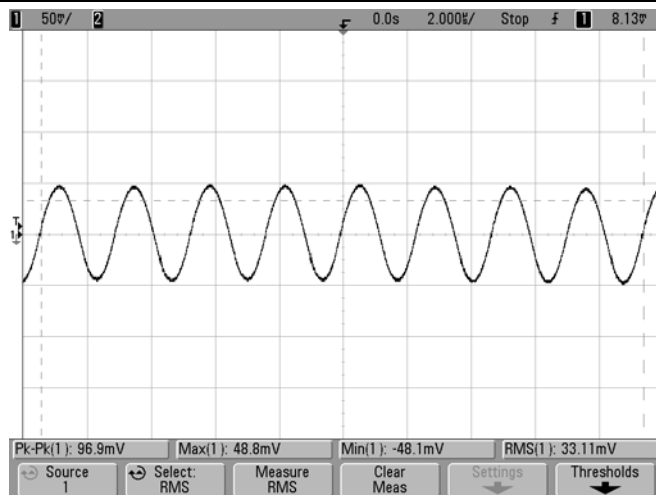

Ripple and Noise @25°C

(Vin = 110V, Vout = nom., Iout= 20A, Cloud = 0, ScopeBW = 20MHz, 2µS/div)

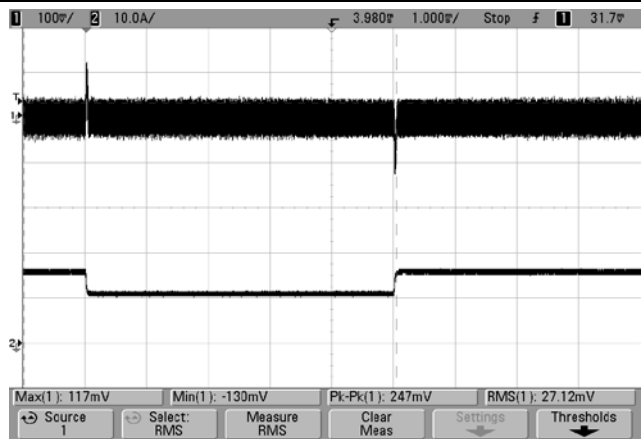

Step Load Transient Response@25°C

(Vin = 110V, Vout = nom., Iout= 75-50-75% of full load, Cloud = 0µF, ScopeBW = 20MHz, 1mS/div)

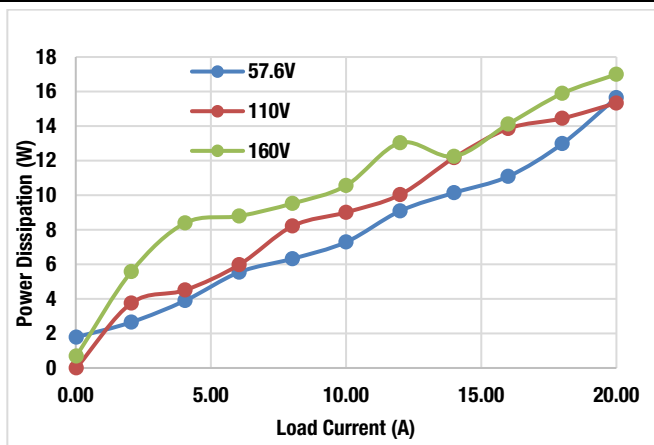

Power Dissipation vs. Load Current @25°C

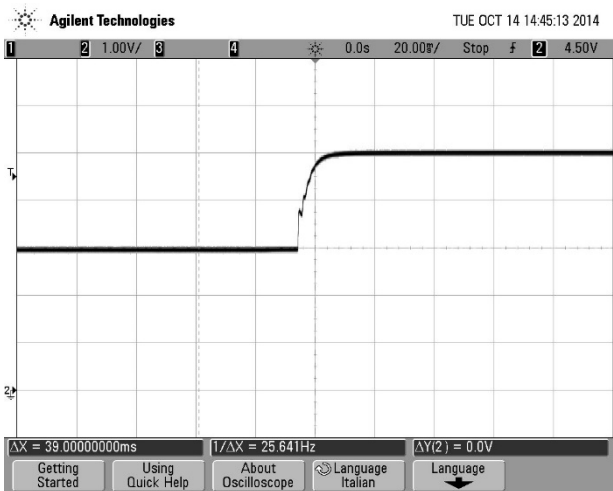

Start-up into a Pre-bias Load@25°C

(Vin = 57.6V, Prebias V = 3V, Cloud = 0µF, 20mS/div)

Thermal Derating (IRQ-5/20-T110, Unit mounted on a 10 X 10 inch PCB)

TRANSVERSE (AIRFLOW FROM Vin- TO Vin+)

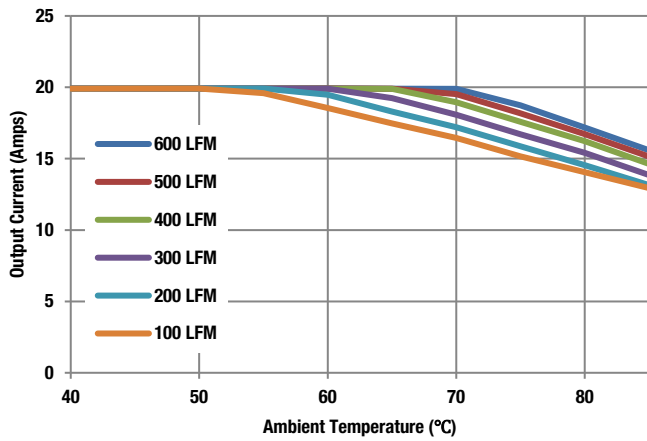

Maximum Current Temperature Derating (Vin = 57.6V)

LONGITUDINAL (AIRFLOW FROM Vin TO Vout)

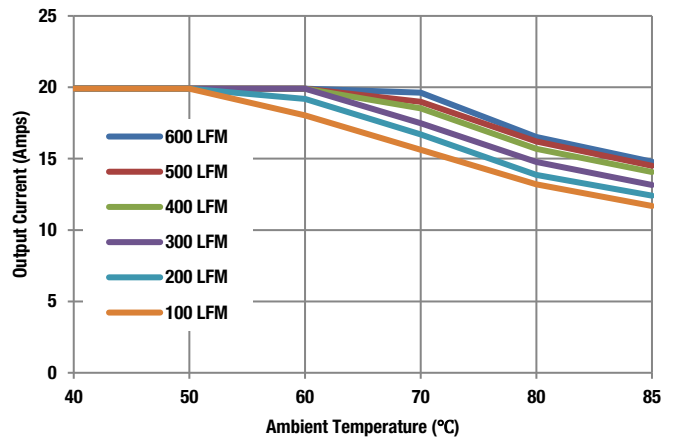

Maximum Current Temperature Derating (Vin = 57.6V)

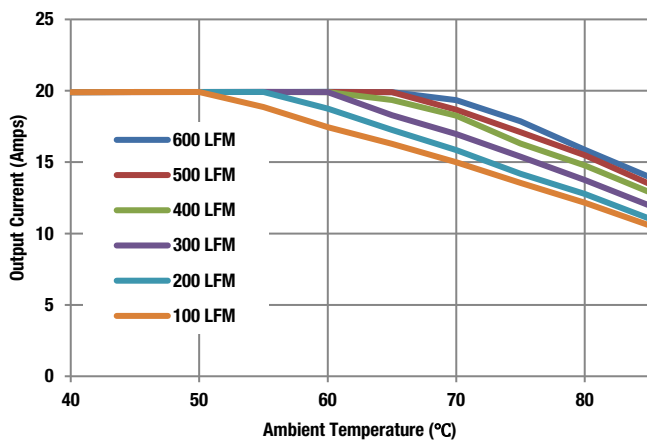

Maximum Current Temperature Derating (Vin = 110V)

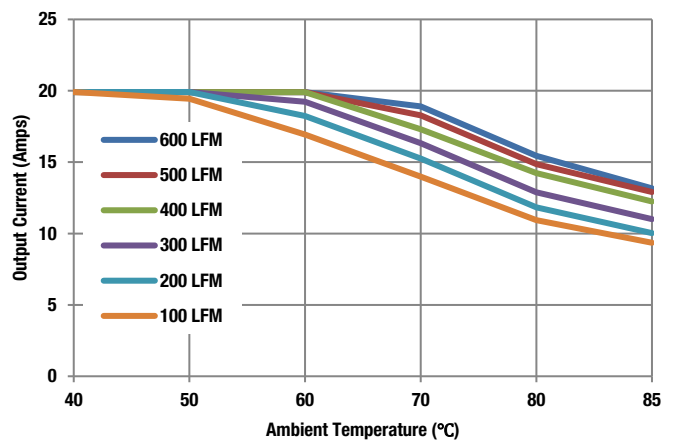

Maximum Current Temperature Derating (Vin = 110V)

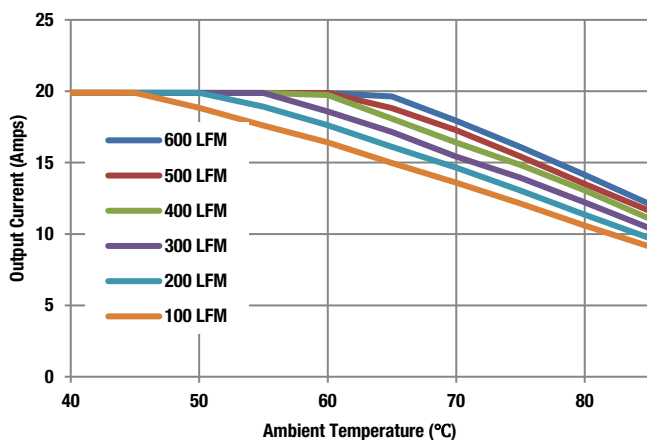

Maximum Current Derating (Vin = 160V)

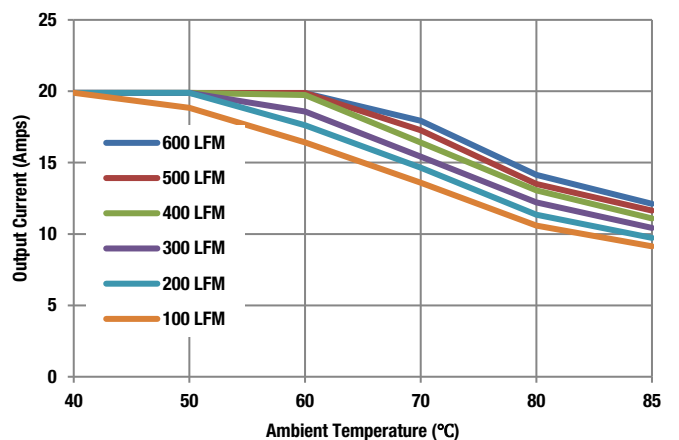

Maximum Current Derating (Vin = 160V)

FUNCTIONAL SPECIFICATIONS (IRQ-12/8.3-T110)

| INPUT | Conditions | Minimum | Typical/Nominal | Maximum | Units |
|---|--|---------|-----------------|---------|----------------------|
| Input current | | | | | |
| Full Load Conditions | Vin = nominal | | 1.00 | 1.50 | A |
| Low Line input current | Vin = minimum | | 1.98 | 2.50 | A |
| Inrush Transient | Vin = 110v | | 0.1 | 0.2 | A ² -Sec. |
| Short Circuit input current | | | 0.02 | 0.05 | A |
| No Load input current | Iout = minimum, unit=ON | | 7 | 50 | mA |
| Shut-Down input current (Off, UV, OT) | | | 5 | 50 | mA |
| Back Ripple Current | Measured at the input of module with a simulated source impedance of 12μH, 220μF, 450V, across source, 33μF, 250V external capacitors across input pins. | | | 600 | mAp-p |
| Internal Filter Type/Value | | | Pi | | |
| Recommended Input fuse | | | | 5 | A |
| OUTPUT | | | | | |
| Total Output Power | | 0 | 99.60 | 100.60 | W |
| Voltage | | | | | |
| Setting Accuracy | At 100% load, no trim, all conditions | 11.88 | 12 | 12.12 | Vdc |
| Output Adjust Range | | 10.8 | | 13.2 | Vdc |
| Overvoltage Protection | See technical notes for details | 14 | 16 | 18 | Vdc |
| Current | | | | | |
| Output Current Range | | 0 | 8.30 | 8.30 | A |
| Minimum Load | | | 0 | | |
| Current Limit Inception | cold condition | 9.13 | 10.50 | 12.45 | A |
| Short Circuit | | | | | |
| Short Circuit Current | Hiccup technique - Auto recovery within 1.25% of Vout | | 1.4 | 3 | A |
| Short Circuit Duration (remove short for recovery) | Output shorted to ground, no damage | | Continuous | | |
| Short circuit protection method | Hiccup current limiting | | Non-latching | | |
| Regulation | | | | | |
| Line Regulation | Vin = 57.6-160, Vout = nom., full load | | | ±0.6 | % |
| Load Regulation | Iout = min. to max., Vin = nom. | | | ±0.5 | % |
| Ripple and Noise | 20 MHz BW, Cout = 1μF | | 50 | 120 | mV pk-pk |
| | paralleled with 10μF | | | | |
| Temperature Coefficient | At all outputs | | | 0.02 | % of Vnom./°C |
| Maximum Output Capacitance | (Loads : CR mode) | | | 1000 | μF |
| | (Loads : CC mode) | | | 1000 | μF |
| GENERAL and SAFETY | | | | | |
| Efficiency | Vin=110V, full load | 87 | 87.4 | | % |

FUNCTIONAL SPECIFICATIONS (IRQ-12/8.3-T110)

| | | | | | |
|-------------------------------------|---|----------------|------------------------|----------------|-------------------------|
| Isolation Resistance | | | 10 | | MΩ |
| Isolation Capacitance | | | 500 | | pF |
| Calculated MTBF | Per Telcordia SR-332, Issue 2, Method 1, Class 1, Ground Fixed, Tcase=+25°C | | 1800 | | Hours x 10 ³ |
| DYNAMIC CHARACTERISTICS | | | | | |
| Switching Frequency | | | 200 | | KHz |
| Turn On Time | | | | | |
| Rise time | 10% Vout to 90% Vout | | 10 | 25 | mS |
| Delay time | Vin on to 10% Vout | | 18 | 30 | mS |
| Dynamic Load Response | 50-75-50%, 1A/us, within 1% of Vout | | 400 | 600 | μSec |
| Dynamic Load Peak Deviation | same as above | | ±200 | ±300 | mV |
| MECHANICAL | Conditions | Minimum | Typical/Nominal | Maximum | Units |
| Outline Dimensions (with baseplate) | | | 2.28x 1.45 x 0.50 | | Inches |
| | | | 57.91x36.83x 12.7 | | mm |
| Weight (with baseplate) | | | 2.23 | | Ounces |
| | | | 63.6 | | Grams |

PERFORMANCE DATA (IRQ-12/8.3-T110)

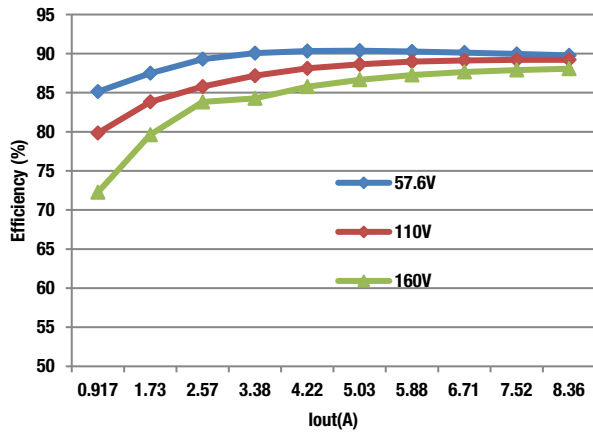

Efficiency vs. Load Current

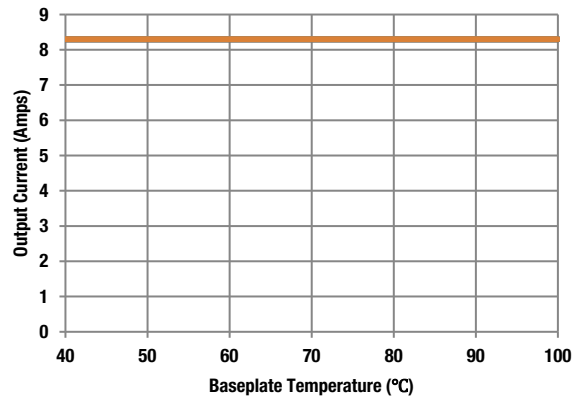

Thermal Derating vs. Baseplate temperature



Turn-on transient at zero load current
(10 mS/div, Top Trace: Vout, 5V/div; Bottom Trace: ON/OFF, 2V/div)



Turn-on transient at full load current
(10 mS/div, Top Trace: Vout, 5V/div; Bottom Trace: ON/OFF, 2V/div)

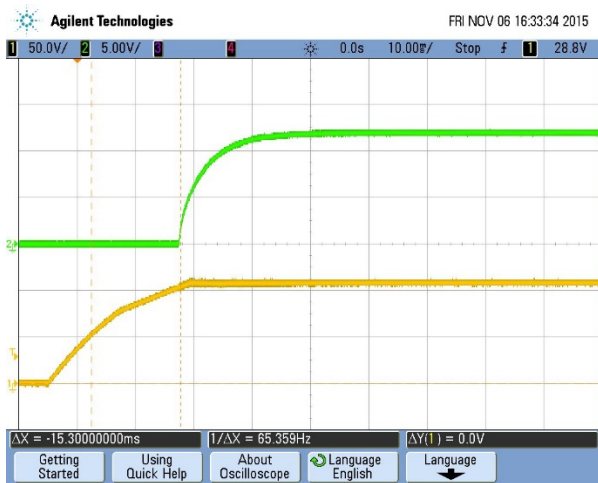

Turn-on transient at zero load current
(10 mS/div, Top Trace: Vout, 5V/div; Bottom Trace: Vin, 50V/div)

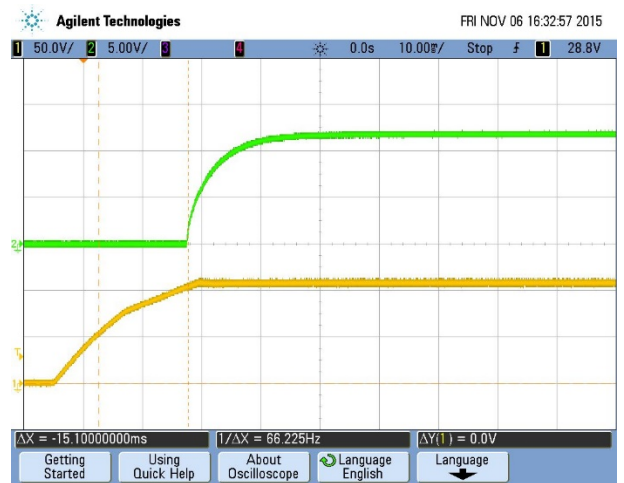

Turn-on transient at full load current
(10 mS/div, Top Trace: Vout, 5V/div; Bottom Trace: Vin, 50V/div)

PERFORMANCE DATA (IRQ-12/8.3-T110)

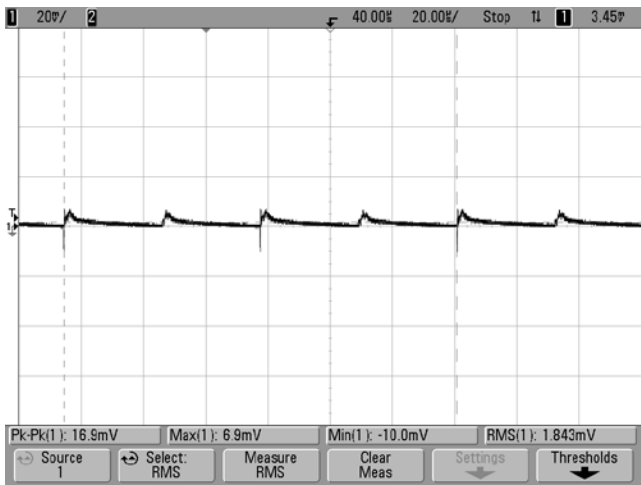

Ripple and Noise @25°C

(Vin = 110V, Vout = nom., Iout = 0, Cloud = 0, ScopeBW = 20MHz, 20µS/div)

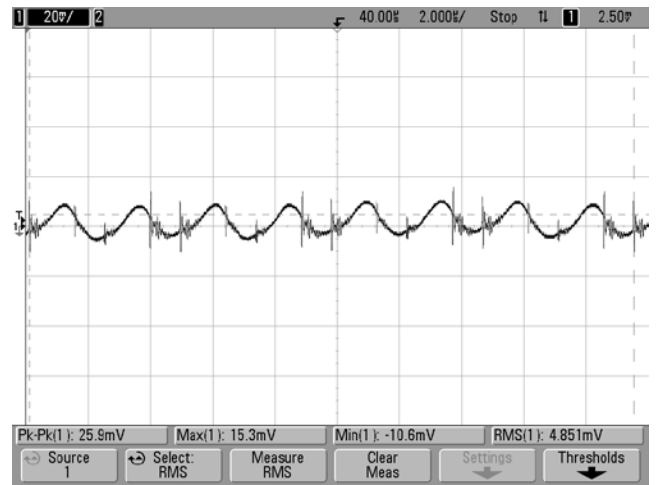

Ripple and Noise @25°C

(Vin = 110V, Vout = nom., Iout = 8.3A, Cloud = 0, ScopeBW = 20MHz, 2µS/div)

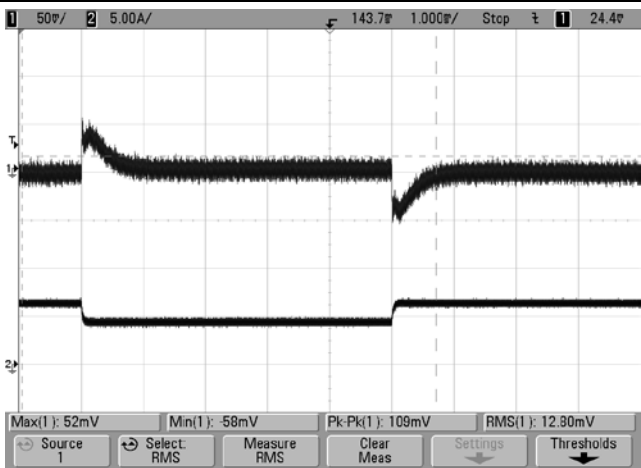

Step Load Transient Response@25°C

(Vin = 110V, Vout = nom., Iout = 75-50-75% of full load, Cloud = 0µF, ScopeBW = 20MHz, 1mS/div)

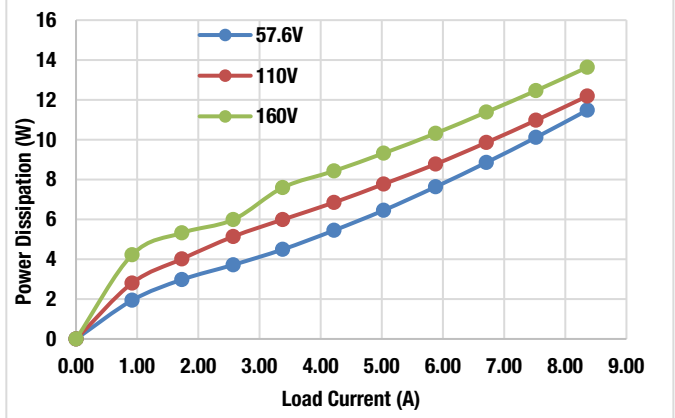

Power Dissipation vs. Load Current @25°C



Start-up into a Pre-bias Load@25°C

(Vin = 57.6V, Prebias V = 4V, Cloud = 0µF, 5mS/div)

Thermal Derating (IRQ-12/8.3-T110, Unit mounted on a 10 X 10 inch PCB)

TRANSVERSE (AIRFLOW FROM Vin- TO Vin+)

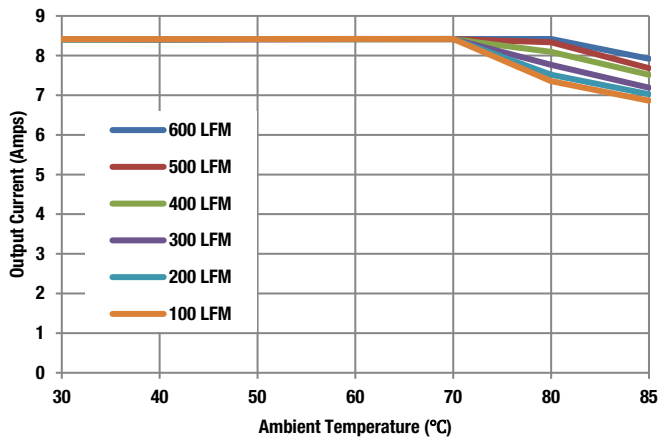

Maximum Current Temperature Derating (Vin = 57.6V)

LONGITUDINAL (AIRFLOW FROM Vin TO Vout)

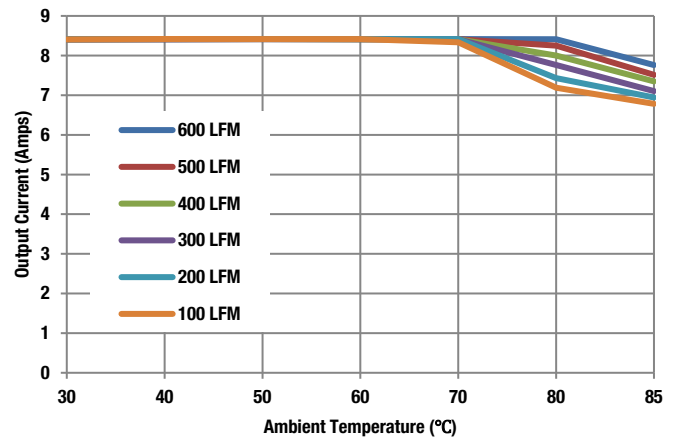

Maximum Current Temperature Derating (Vin = 57.6V)

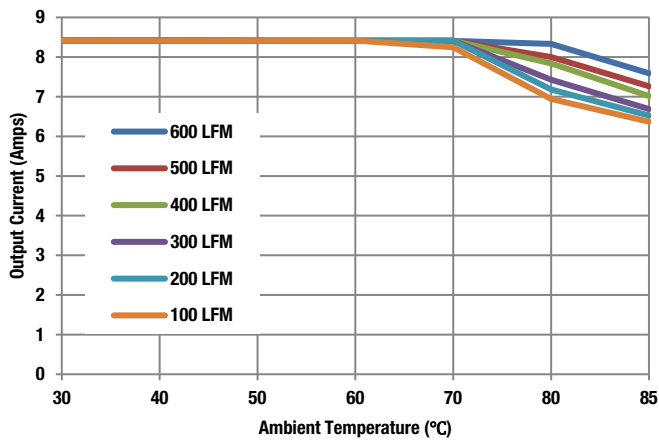

Maximum Current Temperature Derating (Vin = 110V)

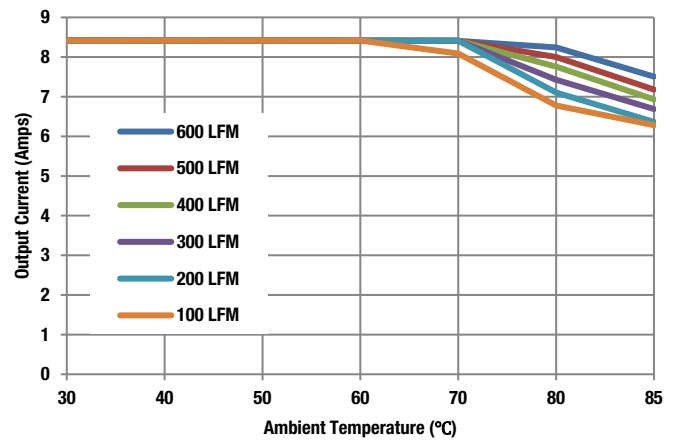

Maximum Current Temperature Derating (Vin = 110V)

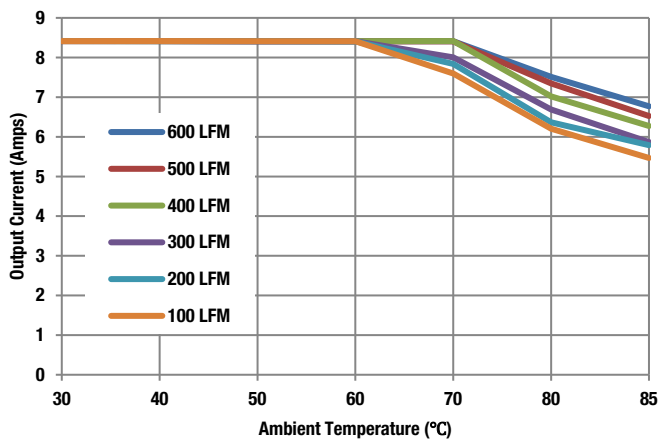

Maximum Current Derating (Vin = 160V)

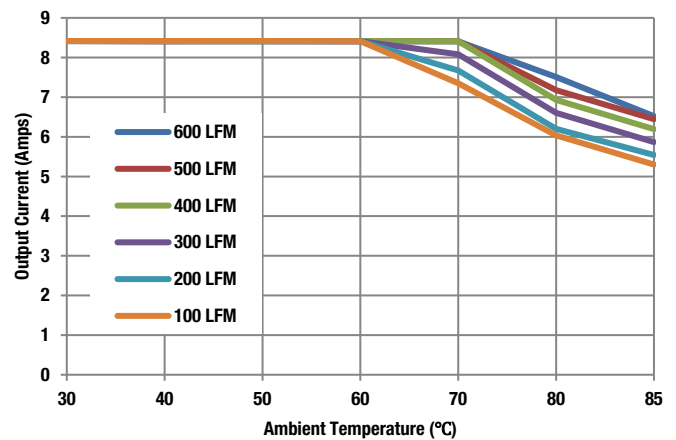

Maximum Current Derating (Vin = 160V)

FUNCTIONAL SPECIFICATIONS (IRQ-24/4.2-T110)

| INPUT | Conditions | Minimum | Typical/Nominal | Maximum | Units |
|---|--|---------|-----------------|---------|----------------------|
| INPUT | | | | | |
| Input Current | | | | | |
| Full Load Conditions | Vin = nominal | | 1.00 | 1.50 | A |
| Low Line input current | Vin = minimum | | 2.02 | 2.50 | A |
| Inrush Transient | Vin = 110v | | 0.1 | 0.2 | A ² -Sec. |
| Short Circuit input current | | | 0.03 | 0.05 | A |
| No Load input current | Iout = minimum, unit=ON | | 7 | 20 | mA |
| Shut-Down input current (Off, UV, OT) | | | 5 | 20 | mA |
| Back Ripple Current | Measured at the input of module with a simulated source impedance of 12μH, 220μF, 450V, across source, 33μF, 250V external capacitors across input pins. | | | 500 | mAp-p |
| Internal Filter Type/Value | | | Pi | | |
| Recommended Input fuse | | | | 5 | A |
| OUTPUT | | | | | |
| Total Output Power | | 0 | 100.80 | 101.81 | W |
| Voltage | | | | | |
| Setting Accuracy | At 100% load, no trim, all conditions | 23.76 | 24 | 24.24 | Vdc |
| Output Adjust Range | | 21.6 | | 26.4 | Vdc |
| Overvoltage Protection | See technical notes for details | 28.8 | 32 | 36 | Vdc |
| Current | | | | | |
| Output Current Range | | 0 | 4.20 | 4.20 | A |
| Minimum Load | | | 0 | | |
| Current Limit Inception | cold condition | 4.62 | 5.67 | 6.30 | A |
| Short Circuit | | | | | |
| Short Circuit Current | Hiccup technique - Auto recovery within 1.25% of Vout | | 1.4 | 3 | A |
| Short Circuit Duration (remove short for recovery) | Output shorted to ground, no damage | | Continuous | | |
| Short circuit protection method | Hiccup current limiting | | Non-latching | | |
| Regulation | | | | | |
| Line Regulation | Vin = 57.6-160, Vout = nom., full load | | | ±0.2 | % |
| Load Regulation | Iout = min. to max., Vin = nom. | | | ±0.3 | % |
| Ripple and Noise | 20 MHz BW, Cout = 1μF | | 100 | 240 | mV pk-pk |
| | paralleled with 10μF | | | | |
| Temperature Coefficient | At all outputs | | | 0.02 | % of Vnom./°C |
| Maximum Output Capacitance | (Loads : CR mode) | | | 560 | μF |
| | (Loads : CC mode) | | | 560 | μF |
| GENERAL and SAFETY | | | | | |
| Efficiency | Vin=110V, full load | 86.5 | 88.2 | | % |

FUNCTIONAL SPECIFICATIONS (IRQ-24/4.2-T110)

| | | | | | |
|-------------------------------------|---|----------------|------------------------|----------------|-------------------------|
| Isolation Resistance | | | 10 | | MΩ |
| Isolation Capacitance | | | 500 | | pF |
| Calculated MTBF | Per Telcordia SR-332, Issue 2, Method 1, Class 1, Ground Fixed, Tcase=+25°C | | 1800 | | Hours x 10 ³ |
| DYNAMIC CHARACTERISTICS | | | | | |
| Switching Frequency | | | 200 | | KHz |
| Turn On Time | | | | | |
| Rise time | 10% Vout to 90% Vout | | 10 | 25 | mS |
| Delay time | Vin on to 10% Vout | | 18 | 30 | mS |
| Dynamic Load Response | 50-75-50%, 1A/us, within 1% of Vout | | 300 | 500 | μSec |
| Dynamic Load Peak Deviation | same as above | | ±400 | ±600 | mV |
| MECHANICAL | Conditions | Minimum | Typical/Nominal | Maximum | Units |
| Outline Dimensions (with baseplate) | | | 2.28x 1.45 x 0.5 | | Inches |
| | | | 57.91x36.83x 12.7 | | mm |
| Weight (with baseplate) | | | 2.23 | | Ounces |
| | | | 63.6 | | Grams |

PERFORMANCE DATA (IRQ-24/4.2-T110)

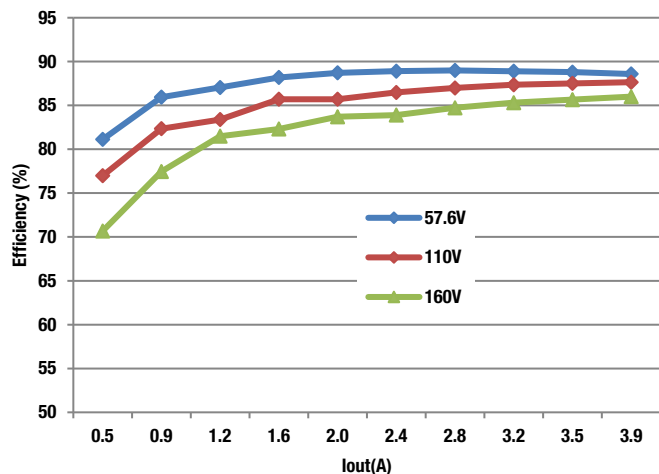

Efficiency vs. Load Current

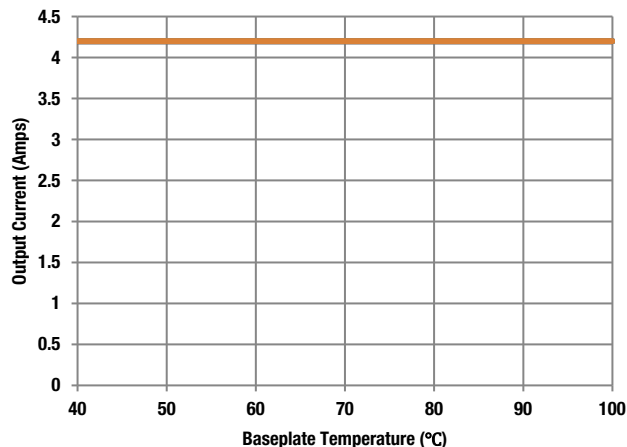

Thermal Derating vs. Baseplate temperature



Turn-on transient at zero load current
(10 mS/div, Top Trace: Vout, 10V/div; Bottom Trace: ON/OFF, 2V/div)



Turn-on transient at full load current
(10 mS/div, Top Trace: Vout, 10V/div; Bottom Trace: ON/OFF, 2V/div)

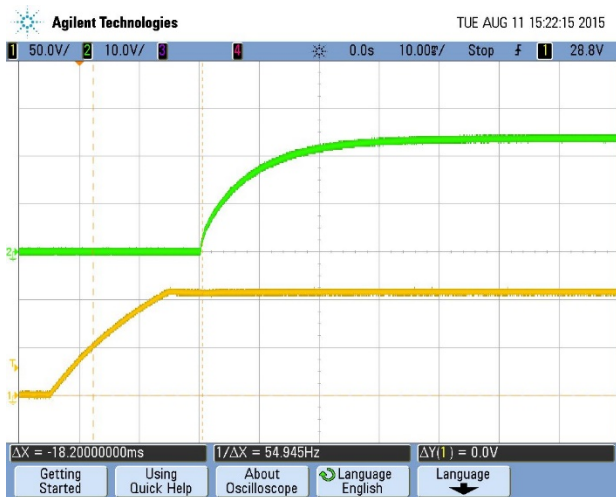

Turn-on transient at zero load current
(10 mS/div, Top Trace: Vout, 10V/div; Bottom Trace: Vin, 50V/div)



Turn-on transient at full load current
(10 mS/div, Top Trace: Vout, 10V/div; Bottom Trace: Vin, 50V/div)

PERFORMANCE DATA (IRQ-24/4.2-T110)

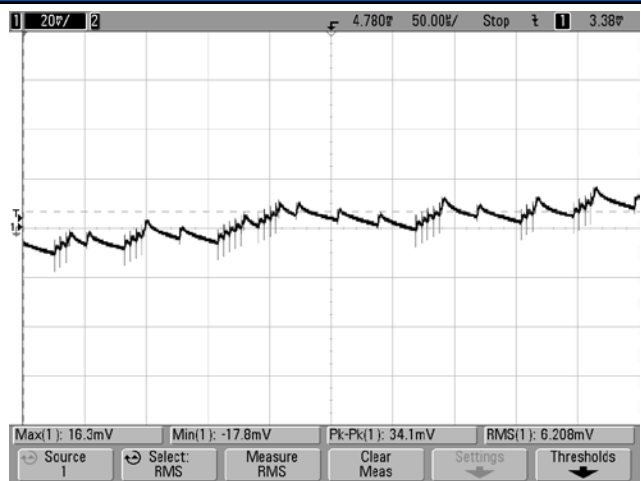

Ripple and Noise @25°C

(Vin = 110V, Vout = nom., Iout = 0, Clod = 0, ScopeBW = 20MHz, 50µS/div)

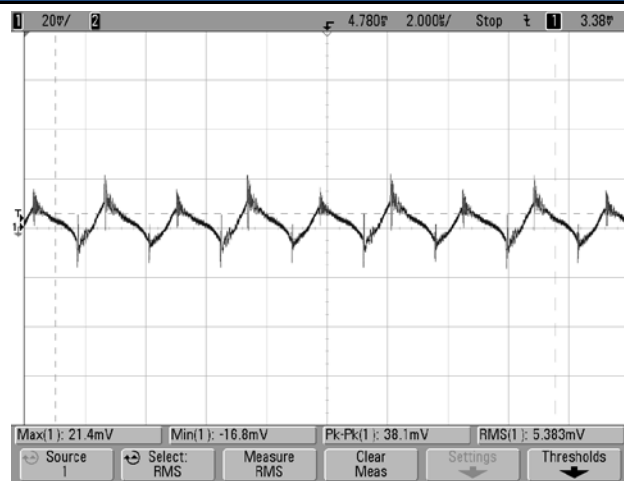

Ripple and Noise @25°C

(Vin = 110V, Vout = nom., Iout = 4.2A, Clod = 0, ScopeBW = 20MHz, 2µS/div)

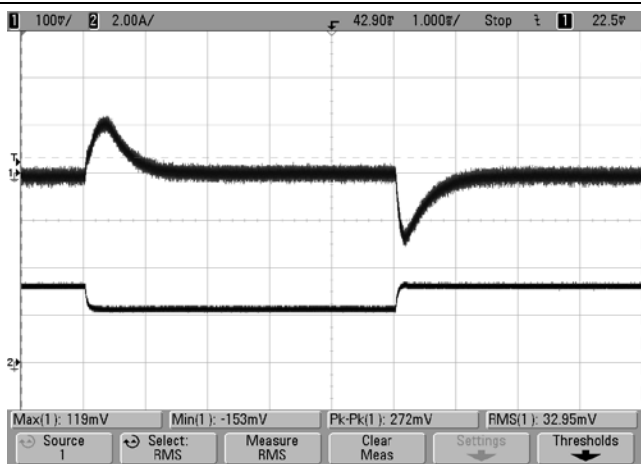

Step Load Transient Response@25°C

(Vin = 110V, Vout = nom., Iout = 75-50-75% of full load, Clod = 0µF, ScopeBW = 20MHz, 1mS/div)

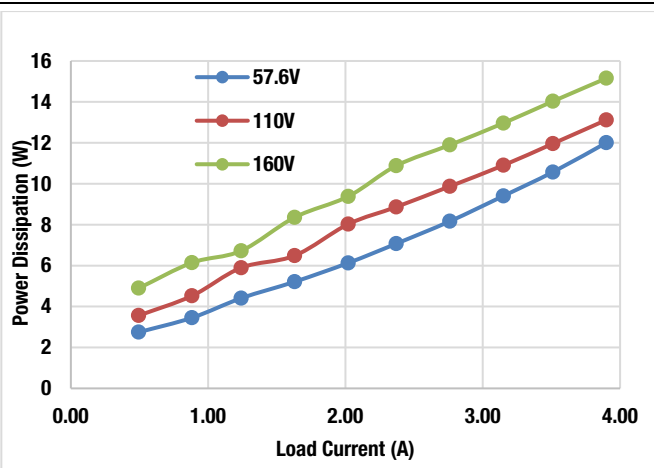

Power Dissipation vs. Load Current @25°C

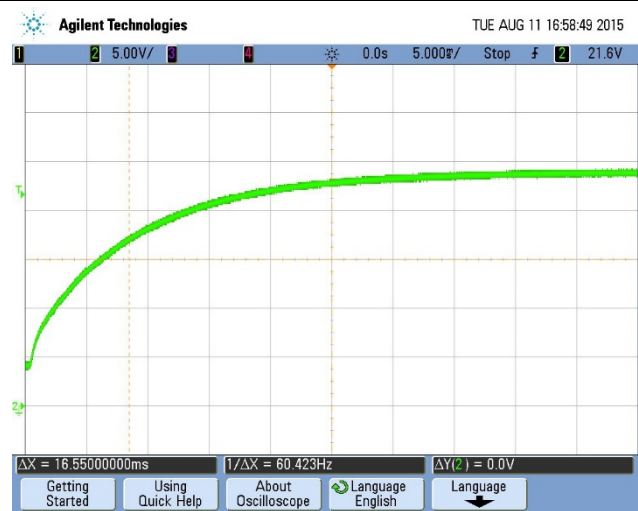

Start-up into a Pre-bias Load@25°C

(Vin = 57.6V, Prebias V = 4V, Clod = 0µF, 5mS/div)

Thermal Derating (IRQ-24/4.2-T110, Unit mounted on a 10 X 10 inch PCB)

TRANSVERSE (AIRFLOW FROM Vin- TO Vin+)

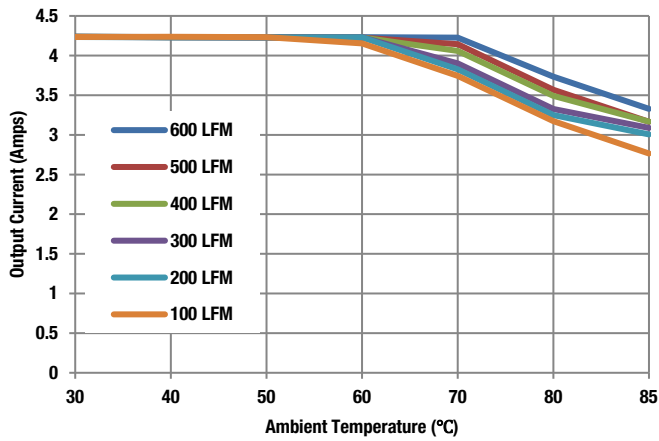

Maximum Current Temperature Derating (Vin = 57.6V)

LONGITUDINAL (AIRFLOW FROM Vin TO Vout)

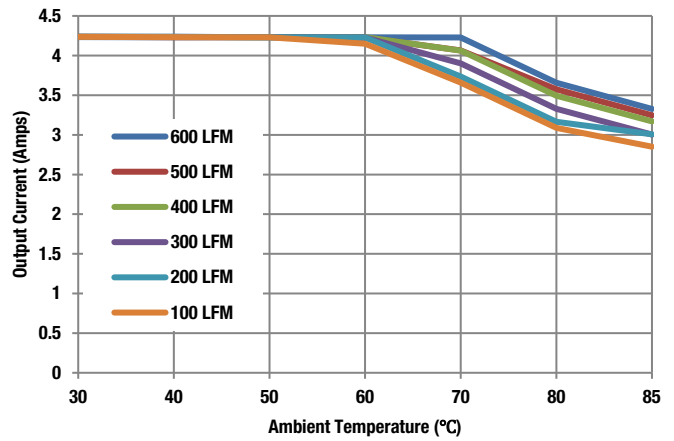

Maximum Current Temperature Derating (Vin = 57.6V)

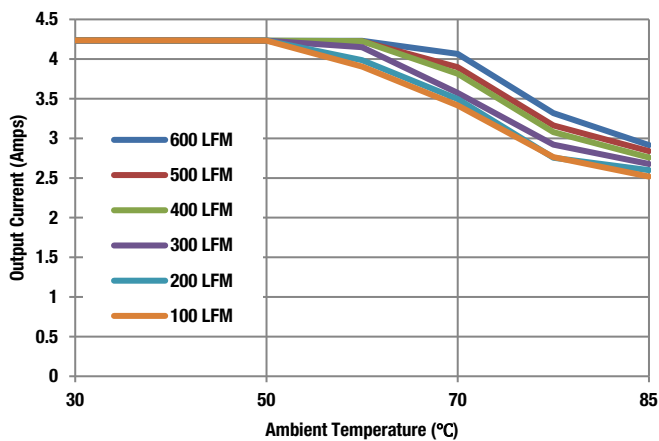

Maximum Current Temperature Derating (Vin = 110V)

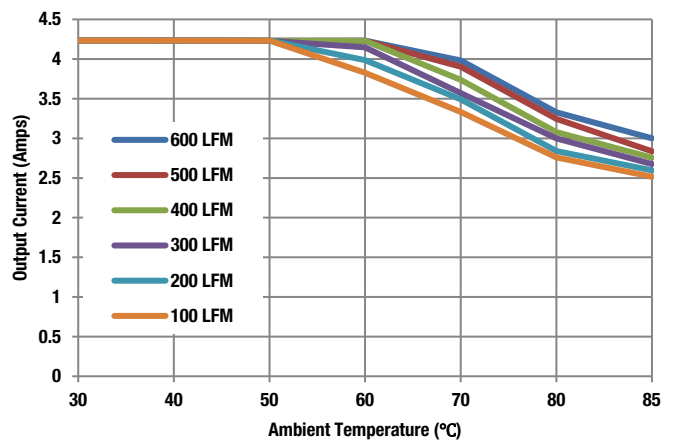

Maximum Current Temperature Derating (Vin = 110V)

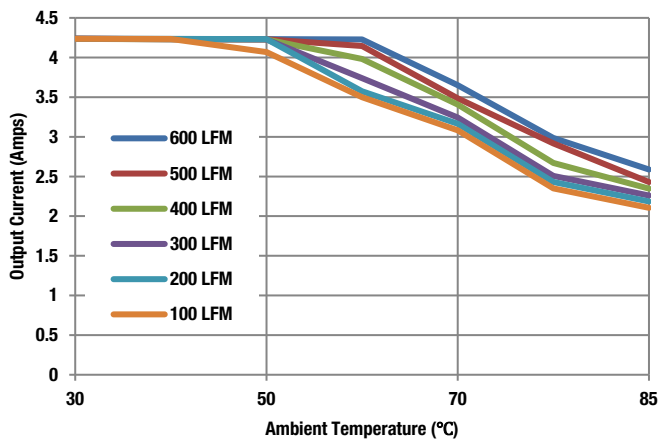

Maximum Current Derating (Vin = 160V)

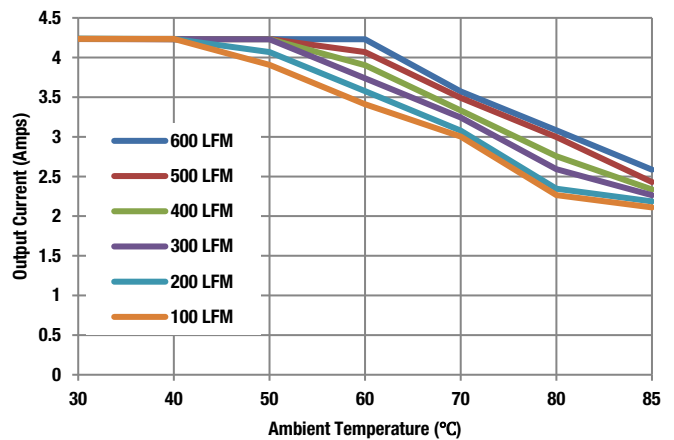

Maximum Current Derating (Vin = 160V)

MECHANICAL SPECIFICATIONS

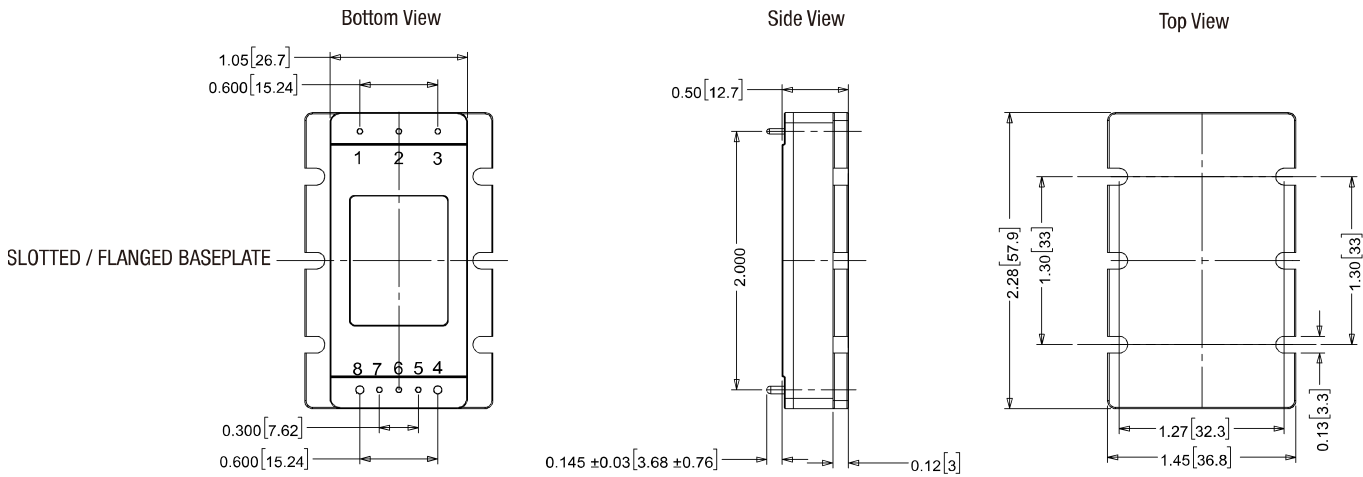

Pin Option#2:
Pin 1-3,5-7: Dia 0.040
Pin 4,8: Dia 0.060

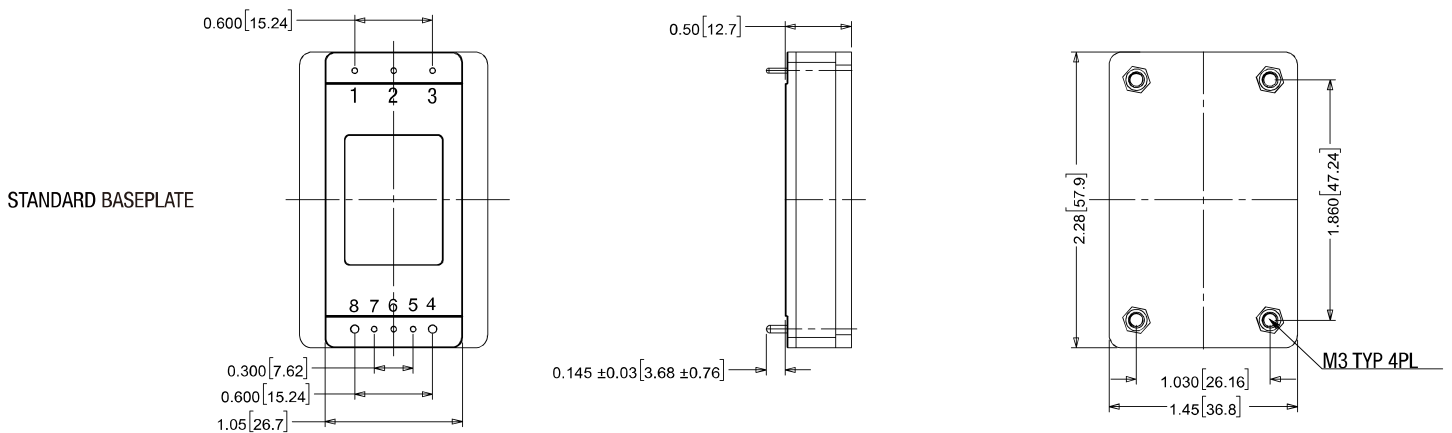

- NOTES:**
 UNLESS OTHERWISE SPECIFIED:
 1: M3 SCREW USED TO BOLT UNIT'S BASEPLATE TO OTHER SURFACES(SUCH AS HEATSINK) MUST NOT EXCEED 0.100" (2.5mm) DEPTH BELOW THE SURFACE OF BASEPLATE
 2: APPLIED TORQUE PER SCREW SHOULD NOT EXCEED 5.3In-lb(0.6Nm);
 3: ALL DIMENSION ARE IN INCHES[MILIMETER];
 4: ALL TOLERANCES: x.xx×in ,±0.02in(x.xxmm,±0.5mm)
 x.x××in ,±0.01in(x.x×mm,±0.25mm)

Material:
 Pin 1-3,5-7: Dia 0.040 PINS: COPPER ALLOY
 Pin 4,8: Dia 0.060 PINS: COPPER ALLOY
 FINISH:(ALL PINS)
 GOLD(5 u"MIN) OVER NICKEL (100u"MIN)

Dimensions are in inches (mm) shown for ref. only.

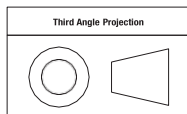

Tolerances (unless otherwise specified):
 .XX ± 0.02 (0.5)
 .XXX ± 0.010 (0.25)
 Angles ± 2°

INPUT/OUTPUT CONNECTIONS

| Pin | Function |
|-----|----------------|
| 1 | Vin(+) |
| 2 | On/Off Control |
| 3 | Vin(-) |
| 4 | Vout(-) |
| 5 | Sense(-) |
| 6 | Trim |
| 7 | Sense(+) |
| 8 | Vout(+) |

MECHANICAL SPECIFICATIONS

Bottom View

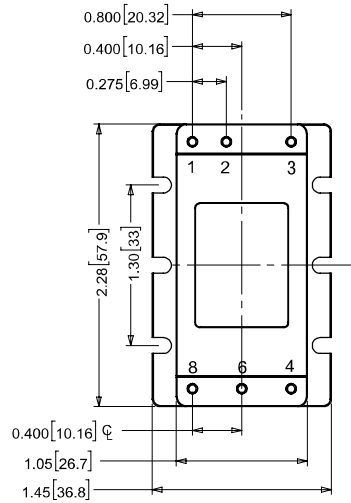

Side View

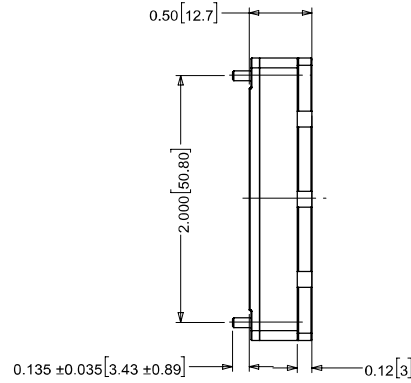

Top View

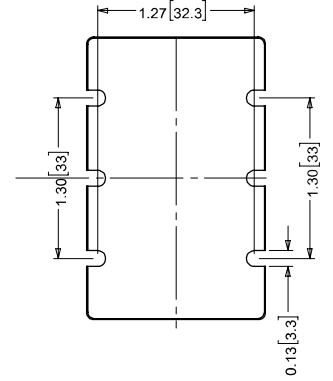

"V" OPTION PINS / PINOUT WITH SLOTTED / FIANGED BASPLATE

Pin Option#1 :
Pin 1-4,6,8: Dia 0.080

- NOTES:
UNLESS OTHERWISE SPECIFIED:
1:M3 SCREW USED TO BOLT UNIT'S BASEPLATE TO OTHER SURFACES(SUCH AS HEATSINK) MUST NOT EXCEED 0.100"(2.5mm) DEPTH BELOW THE SURFACE OF BASEPLATE
2:APPLIED TORQUE PER SCREW SHOULD NOT EXCEED 5.3In-lb(0.6Nm);
3:ALL DIMENSION ARE IN INCHES[MILIMETER];
4:ALL TOLERANCES: ×.××in ,±0.02in(×.×mm,±0.5mm)
×.×××in ,±0.01in(×.××mm,±0.25mm)

Material:
Pin 1-4,6,8: Dia 0.080 PINS: COPPER ALLOY
FINISH:(ALL PINS)
GOLD(5 u"MIN) OVER NICKEL (100u"MIN)

Dimensions are in inches (mm) shown for ref. only.

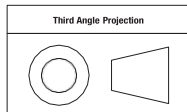

Tolerances (unless otherwise specified):
.XX ± 0.02 (0.5)
.XXX ± 0.010 (0.25)
Angles ± 2°

INPUT/OUTPUT CONNECTIONS

| Pin | Function |
|-----|----------------|
| 1 | Vin(+) |
| 2 | On/Off Control |
| 3 | Vin(-) |
| 4 | Vout(-) |
| 6 | Trim |
| 8 | Vout(+) |

Top View

Pin Option#2

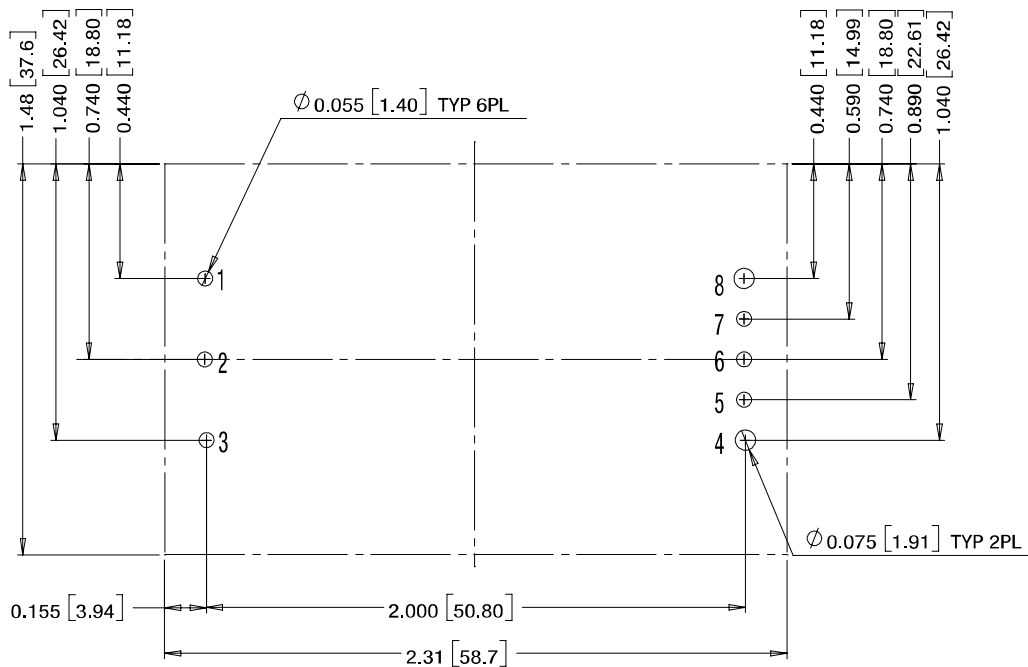

Recommended Footprint for Slotted / Flanged Baseplate and Standard Baseplate

Pin Option#1

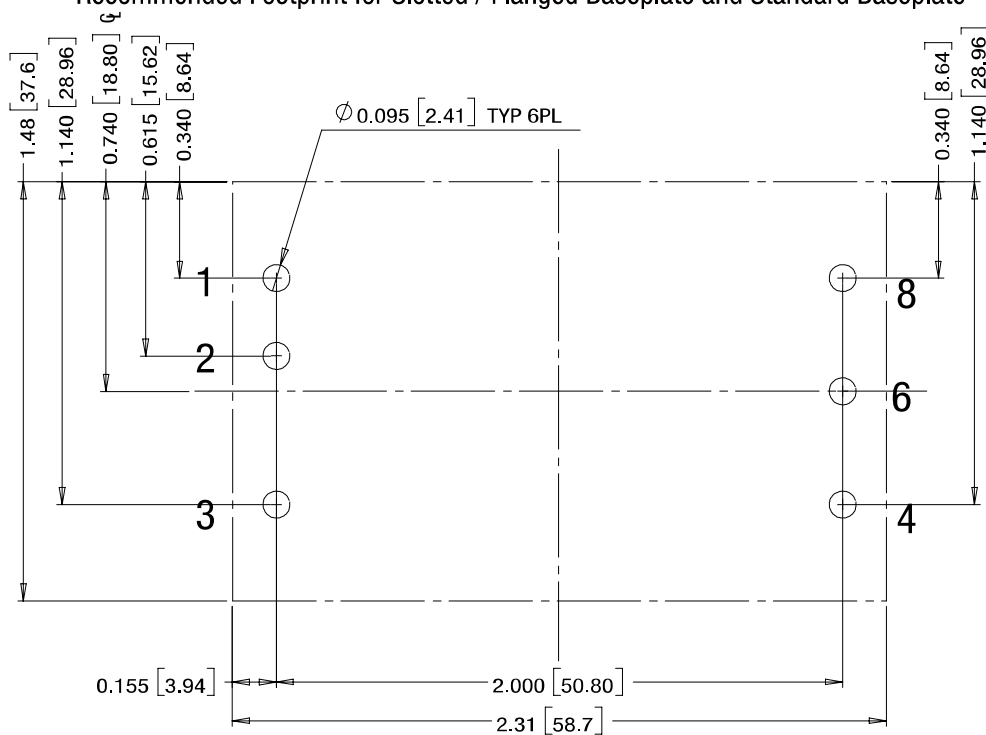

Recommended Footprint for "V" Option Pins / Pinout with Slotted / Flanged Baseplate

SHIPPING TRAYS AND BOXES

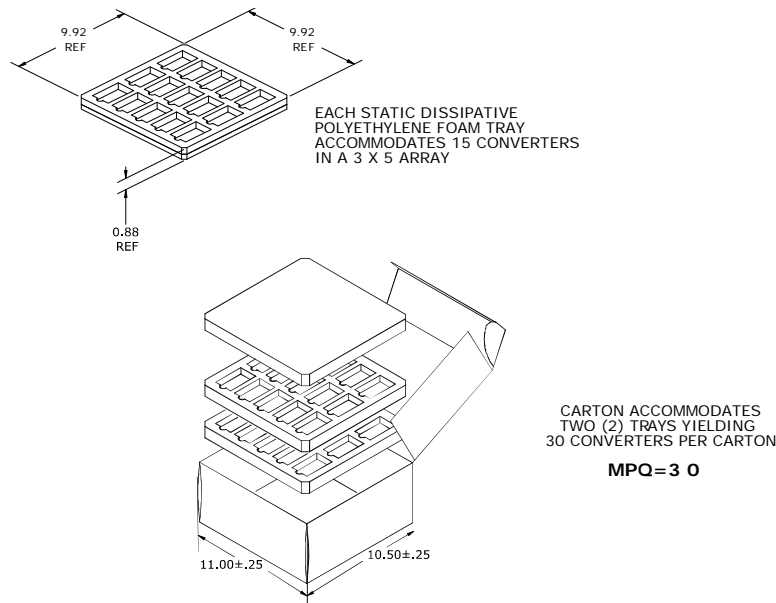

SHIPPING TRAY DIMENSIONS

IRQ modules are supplied in a 15-piece (5 × 3) shipping tray. The tray is an anti-static closed-cell polyethylene foam. Dimensions are shown below.

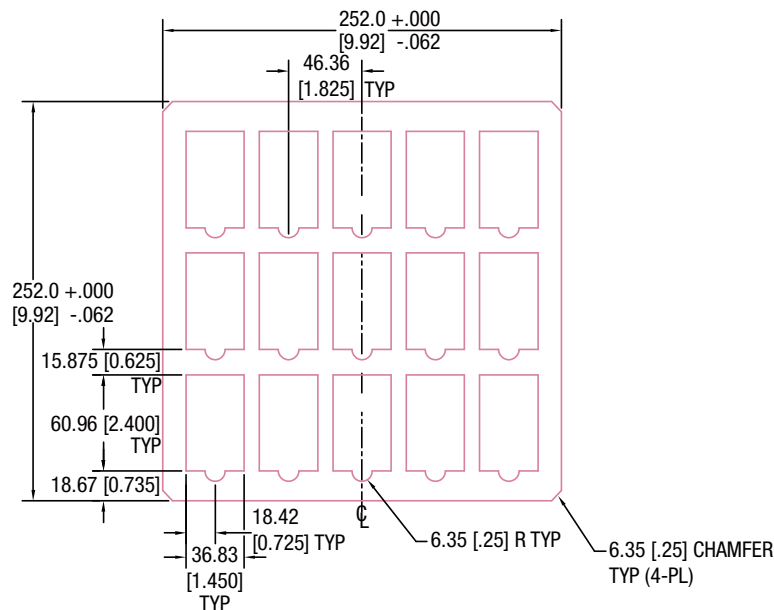

- Notes:
1. Material: Dow 220 antistat ethafoam (Density: 34-35 kg/m³)
 2. Dimensions: 252 x 252 x 19.1 mm
5 x 3 array (15 per tray)
 3. All dimensions in millimeters [inches]
 4. Tolerances unless otherwise specified: +1/-0

STANDARDS COMPLIANCE

| Parameter | Notes |
|---|--|
| EN 60950-1/A12:2011 | Reinforced insulation |
| UL 60950-1/R:2011-12 | |
| CAN/CSA-C22.2 No. 60950-1/A1:2011 | |
| IEC 61000-4-2 | ESD test, 8 kV - NP, 15 kV air - NP (Normal Performance) |
| Note: An external input fuse must always be used to meet these safety requirements. | |

ENVIRONMENTAL QUALIFICATION TESTING

| Parameter | # Units | Test Conditions |
|---|---------|--|
| Vibration | 15 | EN 61373:1999 Category I, Class B, Body mounted |
| Mechanical Shock | 15 | EN 61373:1999 Category I, Class B, Body mounted |
| DMTBF(Life Test) | 60 | Vin nom , units at derating point,101days |
| Temperature Cycling Test(TCT) | 15 | -40 °C to 125 °C, unit temp. ramp 15 °C/min.,500cycles |
| Power and Temperature Cycling Test (PTCT) | 5 | Temperature operating = min to max, Vin = min to max, Load=50% of rated maximum,100cycles |
| Temperature ,Humidity and Bias(THB) | 15 | 85 °C85RH,Vin=max, Load=min load,1072Hour(72hours with a pre-conditioning soak, unpowered) |
| Damp heat test, cyclic | 15 | EN60068-2-30: Temperatures: + 55 °C and + 25 °C; Number of cycles: 2 (respiration effect);Time: 2 x 24 hours; Relative Humidity: 95% |
| Dry heat test | 5 | EN60068-2-2, Vin=nom line, Full load, 85°C for 6 hours. |
| High Temperature Operating Bias(HTOB) | 15 | Vin=min to max ,95% rated load, units at derating point,500hours |
| Low Temperature operating | 5 | Vin=nom line, Full load,-40°C for 2 hours. |
| Highly Accelerated Life Test(HALT) | 5 | High temperature limits, low temperature limits, Vibration limits, Combined Environmental Tests. |
| EMI | 3 | Class A in C1SSPR 22 or IEC62236-3-2(GB/T 24338.4) |
| ESD | 3 | IEC 6100-4-2: +/-8kv contact discharge +/-15kv air discharge |
| Surge Protection | 3 | EN50121-3-2 |
| Solderability | 15Pins | MIL-STD-883, method 2003 (IPC/EIA/JEDEC J-SID-002B) |

Technical Notes

On/Off Control

The input-side, remote On/Off Control function (pin 2) can be ordered to operate with either logic type:

Negative (“N” suffix): Negative-logic devices are off when pin 2 is left open (or pulled high, applying +3.5V to +13V), and on when pin 2 is pulled low (0 to 0.8V) with respect to –Input as shown in Figure 1.

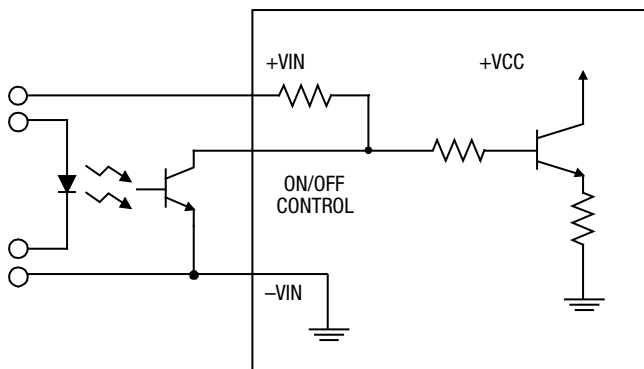

Figure 1. Driving the Negative Logic On/Off Control Pin

Dynamic control of the remote on/off function is best accomplished with a mechanical relay or an open-collector/open-drain drive circuit (optically isolated if appropriate). The drive circuit should be able to sink appropriate current (see Performance Specifications) when activated and withstand appropriate voltage when deactivated. Applying an external voltage to pin 2 when no input power is applied to the converter can cause permanent damage to the converter.

Input Fusing

Certain applications and/or safety agencies may require fuses at the inputs of power conversion components. Fuses should also be used when there is the possibility of sustained input voltage reversal which is not current-limited. For greatest safety, we recommend a fast blow fuse installed in the ungrounded input supply line.

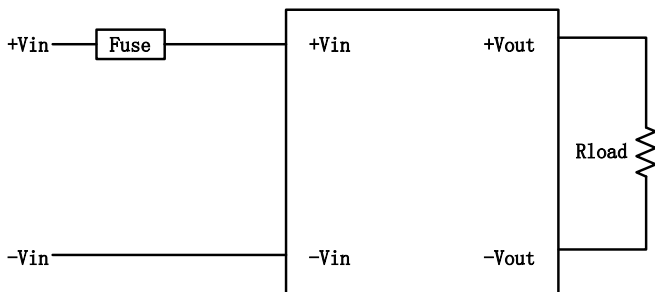

Figure 2. Input Fusing

Input Under-Voltage Shutdown and Start-Up Threshold

Under normal start-up conditions, converters will not begin to regulate properly until the rising input voltage exceeds and remains at the Start-Up Threshold Voltage (see Specifications). Once operating, converters will not turn off until the input voltage drops below the Under-Voltage Shutdown Limit. Subsequent restart will not occur until the input voltage rises again above the Start-Up Threshold. This built-in hysteresis prevents any unstable on/off operation at a single input voltage.

Start-Up Time

Assuming that the output current is set at the rated maximum, the Vin to

Vout Start-Up Time (see Specifications) is the time interval between the point when the rising input voltage crosses the Start-Up Threshold and the fully loaded output voltage enters and remains within its specified accuracy band. Actual measured times will vary with input source impedance, external input capacitance, input voltage slew rate and final value of the input voltage as it appears at the converter.

These converters include a soft start circuit to moderate the duty cycle of its PWM controller at power up, thereby limiting the input inrush current.

The On/Off Remote Control interval from On command to Vout (final ±5%) assumes that the converter already has its input voltage stabilized above the Start-Up Threshold before the On command. The interval is measured from the On command until the output enters and remains within its specified accuracy band. The specification assumes that the output is fully loaded at maximum rated current. Similar conditions apply to the On to Vout regulated specification such as external load capacitance and soft start circuitry.

Recommended Input Filtering

The user must assure that the input source has low AC impedance to provide dynamic stability and that the input supply has little or no inductive content, including long distributed wiring to a remote power supply. The converter will operate with no additional external capacitance if these conditions are met.

For best performance, we recommend installing a low-ESR capacitor immediately adjacent to the converter’s input terminals. The capacitor should be a ceramic type such as the Murata GRM32 series or a polymer type. Make sure that the input terminals do not go below the undervoltage shutdown voltage at all times. More input bulk capacitance may be added in parallel (either electrolytic or tantalum) if needed.

Recommended Output Filtering

The converter will achieve its rated output ripple and noise with no additional external capacitor. However, the user may install more external output capacitance to reduce the ripple even further or for improved dynamic response. Again, use low-ESR ceramic (Murata GRM32 series) or polymer capacitors. Mount these close to the converter. Measure the output ripple under your load conditions.

Use only as much capacitance as required to achieve your ripple and noise objectives. Excessive capacitance can make step load recovery sluggish or possibly introduce instability. Do not exceed the maximum rated output capacitance listed in the specifications.

Input Ripple Current and Output Noise

All models in this converter series are tested and specified for input reflected ripple current and output noise using designated external input/output components, circuits and layout as shown in the figures below. The Cbus and Lbus components simulate a typical DC voltage bus.

Output Over-Voltage Protection

The IRQ output voltage is monitored for an over-voltage condition using a comparator. The signal is optically coupled to the primary side and if the output voltage rises to a level which could be damaging to the load, the sensing circuitry will disable the PWM controller drive causing the output voltage to decrease. It is referred to as “latch” mode.

Encapsulated 100-Watt Isolated DC-DC Converter

Murata Power Solutions makes Characterization measurements in a closed cycle wind tunnel with calibrated airflow. We use both thermocouples and an infrared camera system to observe thermal performance. As a practical matter, it is quite difficult to insert an anemometer to precisely measure airflow in most applications. Sometimes it is possible to estimate the effective airflow if you thoroughly understand the enclosure geometry, entry/exit orifice areas and the fan flow rate specifications.

CAUTION: If you exceed these Derating guidelines, the converter may have an unplanned Over Temperature shut down. Also, these graphs are all collected near Sea Level altitude. Be sure to reduce the derating for higher altitude.

Output Fusing

The converter is extensively protected against current, voltage and temperature extremes. However your output application circuit may need additional protection. In the extremely unlikely event of output circuit failure, excessive voltage could be applied to your circuit. Consider using an appropriate fuse in series with the output.

Output Current Limiting

Current limiting inception is defined as the point at which full power falls below the rated tolerance. See the Performance/Functional Specifications. Note particularly that the output current may briefly rise above its rated value in normal operation as long as the average output power is not exceeded. This enhances reliability and continued operation of your application. If the output current is too high, the converter will enter the short circuit condition.

Output Short Circuit Condition

When a converter is in current-limit mode, the output voltage will drop as the output current demand increases. If the output voltage drops too low (approximately 97% of nominal output voltage for most models), the PWM controller will shut down. Following a time-out period, the PWM will restart, causing the output voltage to begin rising to its appropriate value. If the short-circuit condition persists, another shutdown cycle will initiate. This rapid on/off cycling is called "hiccup mode." The hiccup cycling reduces the average output current, thereby preventing excessive internal temperatures and/or component damage.

The "hiccup" system differs from older latching short circuit systems because you do not have to power down the converter to make it restart. The system will automatically restore operation as soon as the short circuit condition is removed.

Output Capacitive Load

These converters do not require external capacitance added to achieve rated specifications. Users should only consider adding capacitance to reduce switching noise and/or to handle spike current load steps. Install only enough capacitance to achieve noise objectives. Excess external capacitance may cause degraded transient response and possible oscillation or instability.

NOTICE: Please use only this customer data sheet as product documentation when laying out your printed circuit boards and applying this product into your application. Do NOT use other materials as official documentation such as advertisements, product announcements, or website graphics.

We strive to have all technical data in this customer data sheet highly accurate and complete. This customer data sheet is revision-controlled and dated. The latest customer data sheet revision is normally on our website (www.murata-ps.com) for products which are fully released to Manufacturing. Please be especially careful using any data sheets labeled "Preliminary" since data may change without notice.

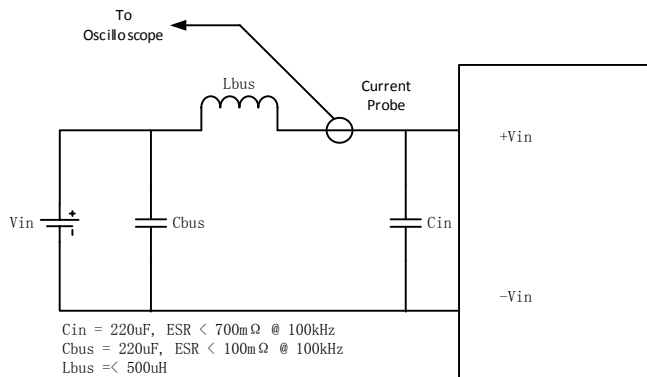

Figure 3. Measuring Input Ripple Current

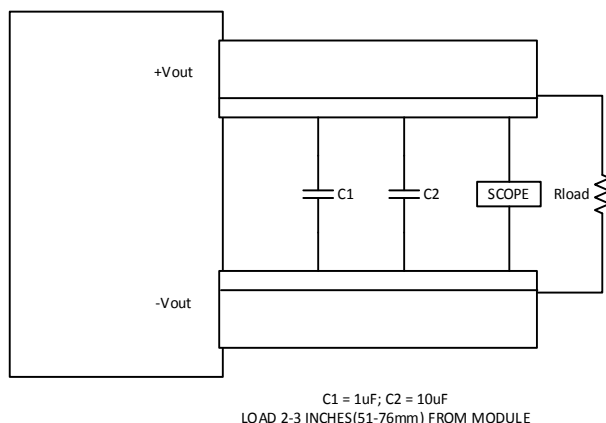

Figure 4 Measuring Output Ripple and Noise (PARD)

Minimum Output Loading Requirements

All models regulate within specification and are stable under no load to full load conditions. Operation under no load might however slightly increase output ripple and noise.

Thermal Shutdown

To prevent many over temperature problems and damage, these converters include thermal shutdown circuitry. If environmental conditions cause the temperature of the DC-DC's to rise above the Operating Temperature Range up to the shutdown temperature, an on-board electronic temperature sensor will power down the unit. When the temperature decreases below the turn-on threshold, the converter will automatically restart. There is a small amount of hysteresis to prevent rapid on/off cycling.

CAUTION: If you operate too close to the thermal limits, the converter may shut down suddenly without warning. Be sure to thoroughly test your application to avoid unplanned thermal shutdown.

Temperature Derating Curves

The graphs in this data sheet illustrate typical operation under a variety of conditions. The Derating curves show the maximum continuous ambient air temperature and decreasing maximum output current which is acceptable under increasing forced airflow measured in Linear Feet per Minute ("LFM"). Note that these are AVERAGE measurements. The converter will accept brief increases in current or reduced airflow as long as the average is not exceeded.

Note that the temperatures are of the ambient airflow, not the converter itself which is obviously running at higher temperature than the outside air.

Encapsulated 100-Watt Isolated DC-DC Converter

Trimming the Output Voltage

The Trim input to the converter allows the user to adjust the output voltage over the rated trim range (please refer to the Specifications). In the trim equations and circuit diagrams that follow, trim adjustments use either a trimpot or a single fixed resistor connected between the Trim input and either the +Sense or –Sense terminals. Trimming resistors should have a low temperature coefficient (± 100 ppm/deg.C or less) and be mounted close to the converter. Keep leads short. If the trim function is not used, leave the trim unconnected. With no trim, the converter will exhibit its specified output voltage accuracy.

There are two CAUTIONs to observe for the Trim input:

CAUTION: To avoid unplanned power down cycles, do not exceed EITHER the maximum output voltage OR the maximum output power when setting the trim. Be particularly careful with a trimpot. If the output voltage is excessive, the OVP circuit may inadvertently shut down the converter. If the maximum power is exceeded, the converter may enter current limiting. If the power is exceeded for an extended period, the converter may overheat and encounter overtemperature shut down.

CAUTION: Be careful of external electrical noise. The Trim input is a sensitive input to the converter’s feedback control loop. Excessive electrical noise may cause instability or oscillation. Keep external connections short to the Trim input. Use shielding if needed.

Trim Equations

Trim Down

Connect trim resistor between trim pin and –Sense

$$R_{TrimDn} (k \Omega) = \frac{V_o}{V_{onom} - V_o}$$

Trim Up

Connect trim resistor between trim pin and +Sense

$$R_{TrimUp} (k \Omega) = \frac{V_{onom} * (V_o - 1.23)}{1.23 * (V_o - V_{onom})} - 1$$

Where,

Do not exceed the specified trim range or maximum power ratings when adjusting trim. Use 1% precision resistors mounted close to the converter on short leads.

If sense is not installed, connect the trim resistor to the respective V_{out} pin.

Trim Circuits

Remote Sense Input

Use the Sense inputs with caution. Sense is normally connected **at the load**. Sense inputs compensate for output voltage inaccuracy delivered at the load. This is done by correcting IR voltage drops along the output wiring and the current carrying capacity of PC board etch. This output drop (the difference between Sense and V_{out} when measured at the converter) should not exceed 0.5V. Consider using heavier wire if this drop is excessive. Sense inputs also improve the stability of the converter and load system by optimizing the control loop phase margin.

NOTE: The Sense input and power V_{out} lines are internally connected through low value resistors to their respective polarities so that the converter can operate without external connection to the Sense. Nevertheless, if the Sense function is not used for remote regulation, the user should connect +Sense to + V_{out} and –Sense to – V_{out} at the converter pins.

The remote Sense lines carry very little current. They are also capacitively coupled to the output lines and therefore are in the feedback control loop to regulate and stabilize the output. As such, they are not low impedance inputs and must be treated with care in PC board layouts. Sense lines on the PCB should run adjacent to DC signals, preferably Ground. In cables and discrete wiring, use twisted pair, shielded tubing or similar techniques.

Any long, distributed wiring and/or significant inductance introduced into the Sense control loop can adversely affect overall system stability. If in doubt, test your applications by observing the converter’s output transient response during step loads. There should not be any appreciable ringing or oscillation. You may also adjust the output trim slightly to compensate for voltage loss in any external filter elements. Do not exceed maximum power ratings.

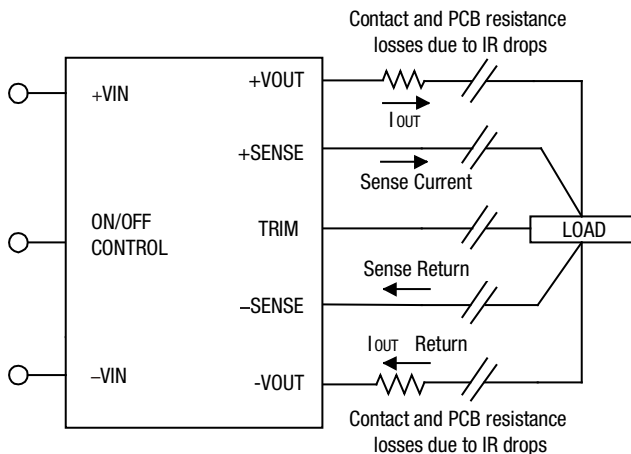

Figure 5 Remote Sense Circuit Configuration

Please observe Sense inputs tolerance to avoid improper operation:

$$[V_{out}(+) - V_{out}(-)] - [Sense(+) - Sense(-)] \leq 10\% \text{ of } V_{out}$$

Output overvoltage protection is monitored at the output voltage pin, not the Sense pin. Therefore excessive voltage differences between V_{out} and Sense together with trim adjustment of the output can cause the overvoltage protection circuit to activate and shut down the output.

Power derating of the converter is based on the combination of maximum output current and the highest output voltage. Therefore the designer must insure:

$$(V_{out} \text{ at pins}) \times (I_{out}) \leq (\text{Max. rated output power})$$

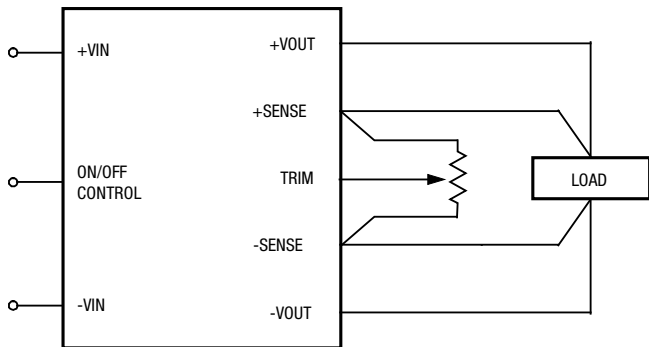

Figure 6 Trim Connections Using A Trimpot

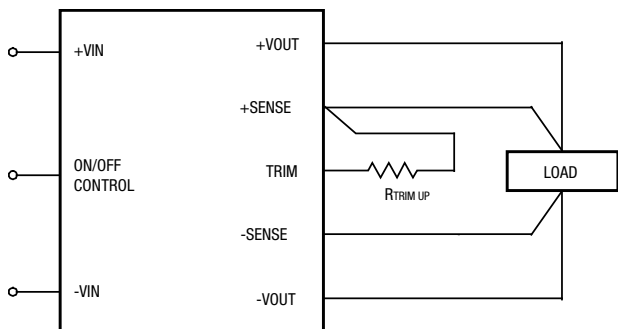

Figure 7 Trim Connections to Increase Output Voltages

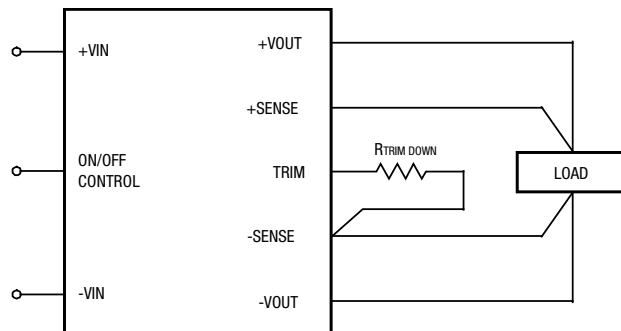
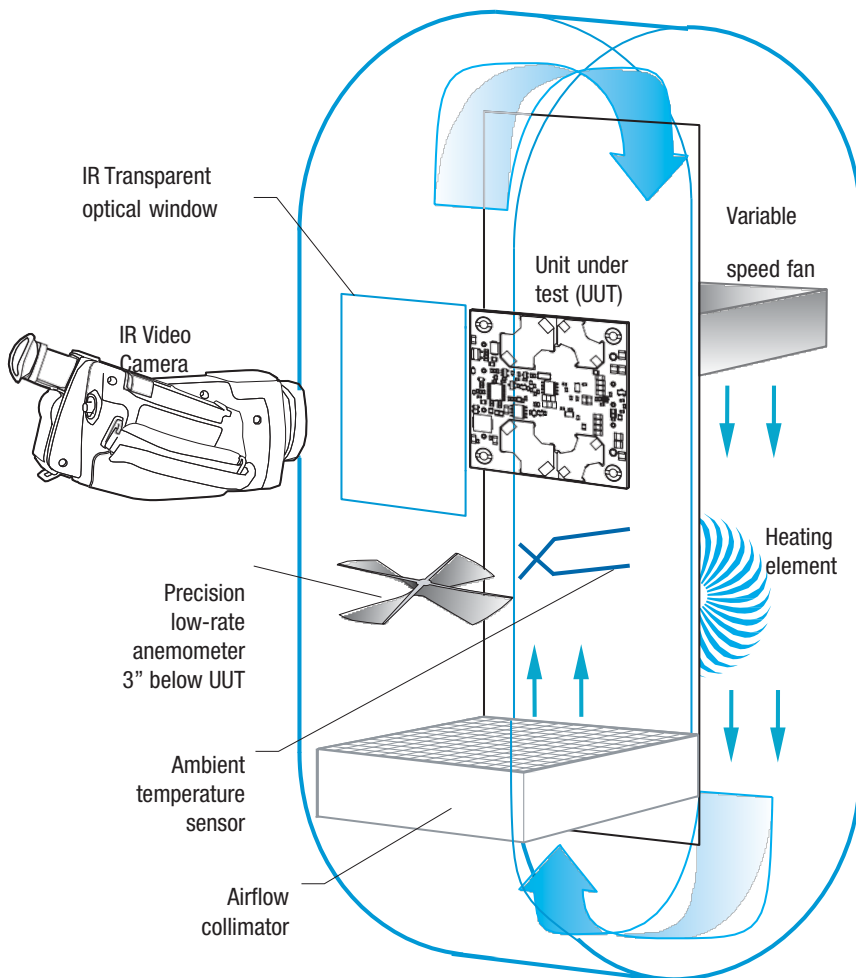

Figure 8 Trim Connections to Decrease Output Voltage

Soldering Guidelines

Murata Power Solutions recommends the specifications below when installing these converters. These specifications vary depending on the solder type. Exceeding these specifications may cause damage to the product. Your production environment may differ; therefore please thoroughly review these guidelines with your process engineers.

| Wave Solder Operations for through-hole mounted products (THMT) | | | |
|--|-----------|---------------------------------|-----------|
| For Sn/Ag/Cu based solders: | | For Sn/Pb based solders: | |
| Maximum Preheat Temperature | 115° C | Maximum Preheat Temperature | 105° C |
| Maximum Pot Temperature | 270° C | Maximum Pot Temperature | 250° C |
| Maximum Solder Dwell Time | 7 seconds | Maximum Solder Dwell Time | 6 seconds |



Vertical Wind Tunnel

Murata Power Solutions employs a computer controlled custom-designed closed loop vertical wind tunnel, infrared video camera system, and test instrumentation for accurate airflow and heat dissipation analysis of power products. The system includes a precision low flow-rate anemometer, variable speed fan, power supply input and load controls,

temperature gauges, and adjustable heating element.

The IR camera monitors the thermal performance of the Unit Under Test (UUT) under static steady-state conditions. A special optical port is used which is transparent to infrared wavelengths.

Both through-hole and surface mount converters are soldered down to a 10"x10" host carrier board for realistic heat absorption and spreading. Both longitudinal and transverse airflow studies are possible by rotation of this carrier board since there are often significant differences in the heat dissipation in the two airflow directions. The combination of adjustable airflow, adjustable ambient heat, and adjustable Input/Output currents and voltages mean that a very wide range of measurement conditions can be studied.

The collimator reduces the amount of turbulence adjacent to the UUT by minimizing airflow turbulence. Such turbulence influences the effective heat transfer characteristics and gives false readings. Excess turbulence removes more heat from some surfaces and less heat from others, possibly causing uneven overheating.

Both sides of the UUT are studied since there are different thermal gradients on each side. The adjustable heating element and fan, built-in temperature gauges, and no-contact IR camera mean that power supplies are tested in real-world conditions.

PRODUCT STATUS

| MPS Part Number | Product Status | LTB Date |
|----------------------|--------------------|-----------|
| IRQ-12/8.3-T110N-C | To be discontinued | 3/31/2024 |
| IRQ-12/8.3-T110NF-C | In Production | N/A |
| IRQ-12/8.3-T110NVF-C | To be discontinued | 3/31/2024 |
| IRQ-12/8.3-T110P-C | To be discontinued | 3/31/2024 |
| IRQ-12/8.3-T110PF-C | To be discontinued | 3/31/2024 |
| IRQ-12/8.3-T110PVF-C | In Production | N/A |
| IRQ-24/4.2-T110N-C | In Production | N/A |
| IRQ-24/4.2-T110NF-C | In Production | N/A |
| IRQ-24/4.2-T110NVF-C | To be discontinued | 3/31/2024 |
| IRQ-24/4.2-T110P-C | To be discontinued | 3/31/2024 |
| IRQ-24/4.2-T110PF-C | In Production | N/A |
| IRQ-24/4.2-T110PVF-C | To be discontinued | 3/31/2024 |
| IRQ-5/20-T110N-C | To be discontinued | 3/31/2024 |
| IRQ-5/20-T110NF-C | To be discontinued | 3/31/2024 |
| IRQ-5/20-T110NVF-C | To be discontinued | 3/31/2024 |
| IRQ-5/20-T110P-C | To be discontinued | 3/31/2024 |
| IRQ-5/20-T110PF-C | To be discontinued | 3/31/2024 |
| IRQ-5/20-T110PVF-C | To be discontinued | 3/31/2024 |

Product Status ✕

| | |
|--------------------|--|
| Under Development | Products under development. Listed product specifications are subject to change without prior notice. Please contact us for sample availability and mass production schedule. |
| In Production | Product is in mass production. |
| NRND | Not recommended for new design. |
| To be discontinued | We are planning to discontinue production of this item. 'Last Time Buy' date or Discontinuation date may be shown on our web site. Before these dates, please contact us with your requirements. |
| Discontinued | Production of this product has stopped. |
| Recommended | Murata particularly recommends this product for reasons of size and performance. Please contact Murata regarding pricing and delivery. |
| New | This is a new product. Please contact Murata regarding pricing and delivery. |

Murata Power Solutions, Inc.
 129 Flanders Road, Westborough, MA 01581 U.S.A.
 ISO 9001 and 14001 REGISTERED



This product is subject to the following operating requirements and the Life and Safety Critical Application Sales Policy:
 Refer to: <http://www.murata-ps.com/requirements/>

Murata Power Solutions, Inc. makes no representation that the use of its products in the circuits described herein, or the use of other technical information contained herein, will not infringe upon existing or future patent rights. The descriptions contained herein do not imply the granting of licenses to make, use, or sell equipment constructed in accordance therewith. Specifications are subject to change without notice. © 2023 Murata Power Solutions, Inc.