

Features

- Ideal for indication light on hand held products
- Long life and robust package
- Standard Package: 4,000pcs/ Reel
- MSL (Moisture Sensitivity Level): 3
- Low current $I_F=2\text{mA}$ operating.
- Halogen-free
- RoHS compliant



ATTENTION
OBSERVE PRECAUTIONS
FOR HANDLING
ELECTROSTATIC
DISCHARGE
SENSITIVE
DEVICES

Package Schematics

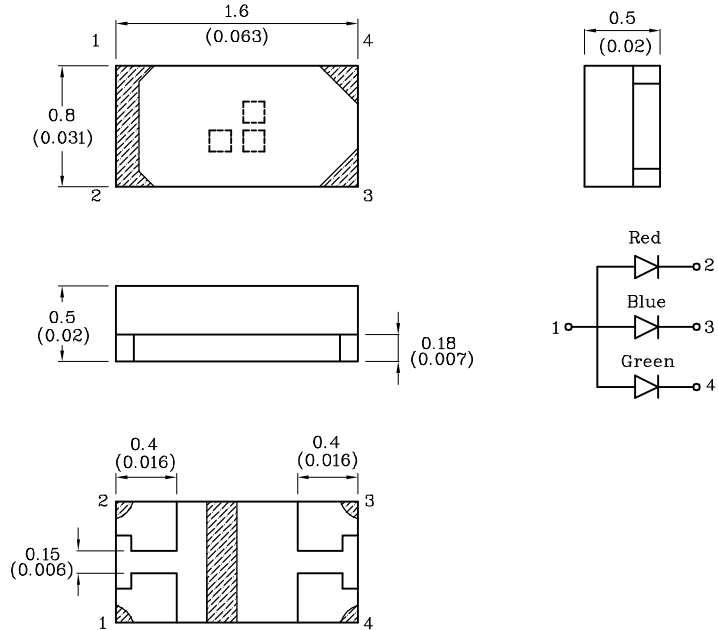

Notes:

1. All dimensions are in millimeters (inches).
2. Tolerance is $\pm 0.15(0.006)$ " unless otherwise noted.
3. Specifications are subject to change without notice.

Absolute Maximum Ratings ($T_A=25^\circ\text{C}$)		Red (AlGaInP)	Blue (InGaN)	Green (InGaN)	Unit
Power Dissipation	P_D [1]	75	80	82	mW
Reverse Voltage	V_R	5	5	5	V
Junction Temperature	T_J	115	115	115	$^\circ\text{C}$
Operating Temperature	T_A	-40 to +85			$^\circ\text{C}$
Storage Temperature	T_{stg}	-40 to +85			$^\circ\text{C}$
DC Forward Current	I_F [1]	30	20	20	mA
Forward Current (Peak) 1/10 Duty Cycle, 0.1ms Pulse Width	i_{FS}	195	100	100	mA
Electrostatic Discharge Threshold (HBM)	-	3000	250	450	V
Thermal Resistance (Junction / Ambient)	$R_{th(j-a)}$ [2]	730	720	700	$^\circ\text{C}/\text{W}$
Thermal Resistance (Junction / Solder point)	$R_{th(j-s)}$ [2]	610	620	590	$^\circ\text{C}/\text{W}$

Notes:

1. The maximum ratings are valid for the case of lighting a single chip
When two chips are lit at the same time, each chip should be driven at a current lower than 50% of the absolute maximum ratings
When three chips are lit at the same time, each chip should be driven at a current lower than 30% of the absolute maximum ratings
2. $R_{th(j-a)}$, $R_{th(j-s)}$ Results from mounting on PC board FR4 (pad size $\geq 16\text{ mm}^2$ per pad).
3. A Relative Humidity between 40% and 60% is recommended in ESD-protected work areas to reduce static build up during assembly process (Reference JEDEC/JESD625-A and JEDEC/J-STD-033)

Operating Characteristics (T _A =25°C)		Red (AlGaInP)	Blue (InGaN)	Green (InGaN)	Unit
Wavelength of Peak Emission CIE127-2007* (Typ.) (I _F =2mA)	λ P	630*	460*	515*	nm
Wavelength of Dominant Emission CIE127-2007* (Typ.) (I _F =2mA)	λ D	621*	465*	525*	nm
Spectral Line Full Width at Half-Maximum (Typ.) (I _F =2mA)	Δλ	20	25	35	nm
Capacitance (Typ.) (V _F =0V, f=1MHz)	C	25	100	45	pF
Forward Voltage I _F =2mA (Typ.)	V _F	1.8	2.65	2.65	V
Forward Voltage I _F =2mA (Max.)	V _F	2.1	3.1	3.1	V
Reverse Current (V _R = 5V) (Max.)	I _R	10	50	50	μA
Temperature Coefficient of λ peak (Typ.) I _F =2mA, -10°C ≤ T ≤ 85°C	TC λ peak	0.13	0.04	0.05	nm/°C
Temperature Coefficient of λ dom (Typ.) I _F =2mA, -10°C ≤ T ≤ 85°C	TC λ dom	0.06	0.03	0.03	nm/°C
Temperature Coefficient of V _F (Typ.) I _F =2mA, -10°C ≤ T ≤ 85°C	TC _V	-1.9	-2.9	-2.9	mV/°C

Part Number	Emitting Color	Emitting Material	Lens-color	Luminous Intensity CIE127-2007* (I _F =2mA) mcd		Wavelength CIE127-2007* nm λP	Viewing Angle 2θ 1/2
				min.	typ.		
XZCMECBDDGK53W	Red	AlGaInP	Water Clear	4*	14*	630*	140°
	Blue	InGaN		4*	9*	460*	
	Green	InGaN		20*	69*	515*	

*Luminous intensity value and wavelength are in accordance with CIE127-2007 standards.

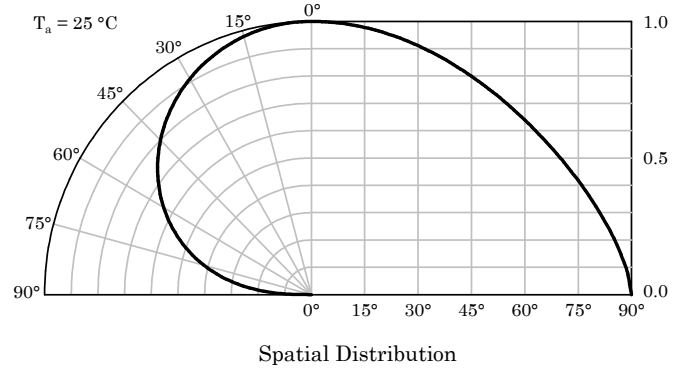
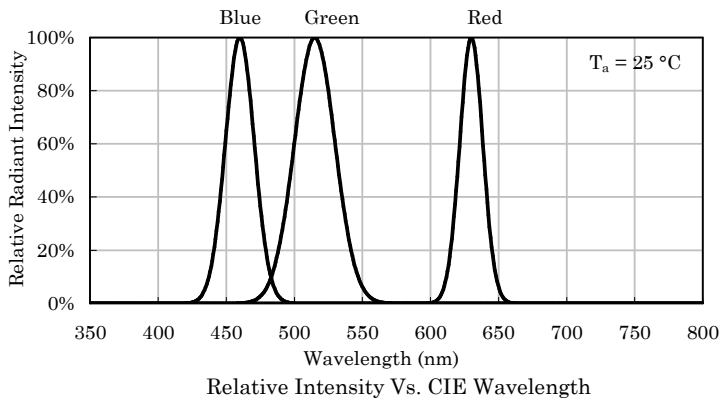

❖ **Red**

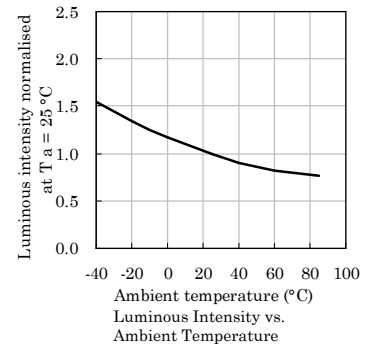
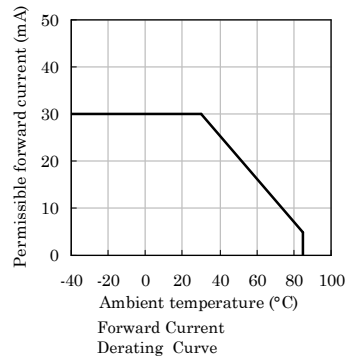
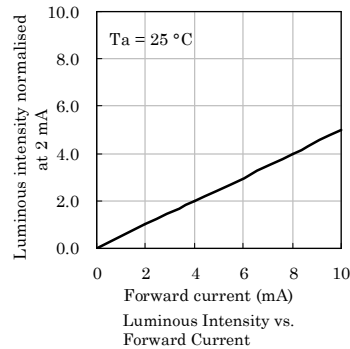
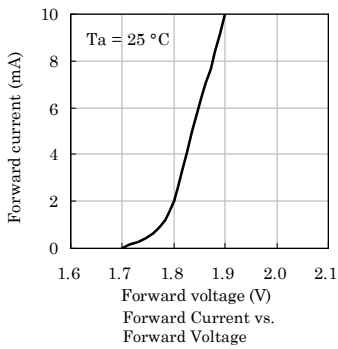

❖ **Blue**

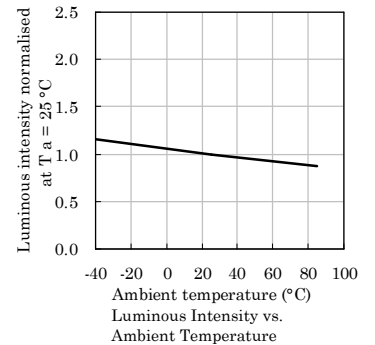
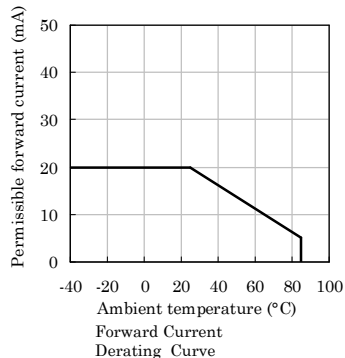
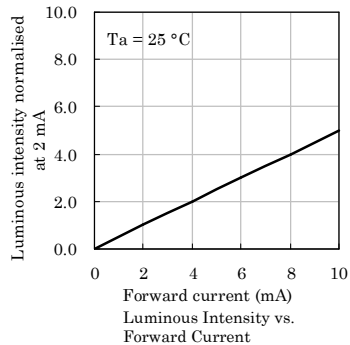
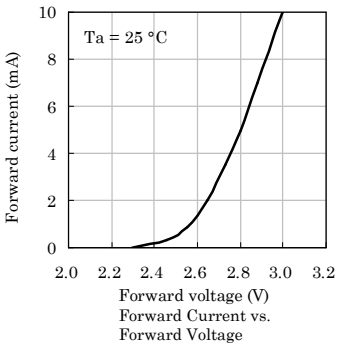

❖ **Green**

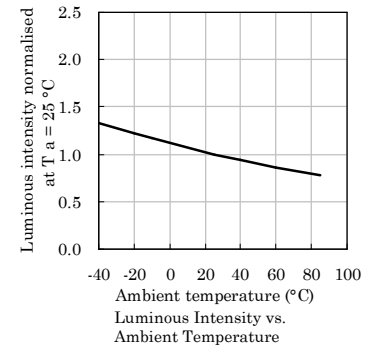
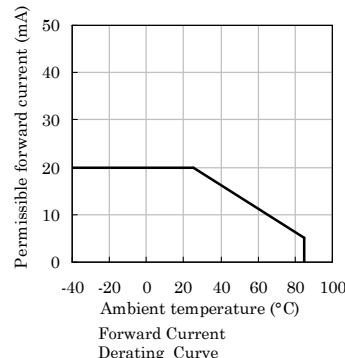
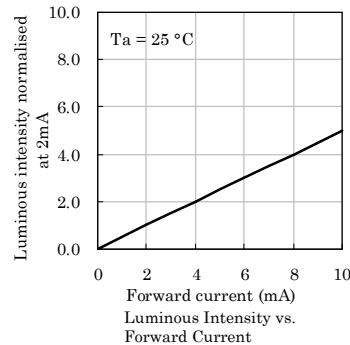
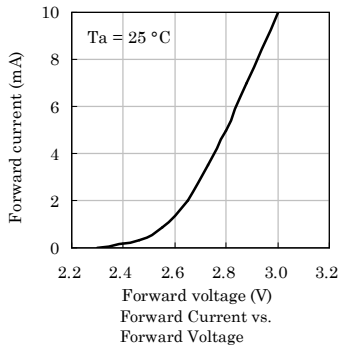

LED is recommended for reflow soldering and soldering profile is shown below.

❖ The device has a single mounting surface. The device must be mounted according to the specifications.

Reflow Soldering Profile for SMD Products (Pb-Free Components)

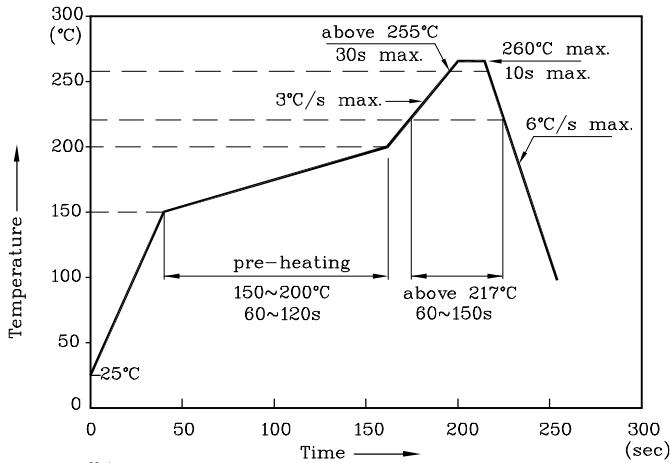

Notes:

1. All temperatures refer to the center of the package, measured on the package body surface facing up during reflow.
2. Do not apply any stress to the LED during high temperature conditions.
3. Maximum number of soldering passes: 2

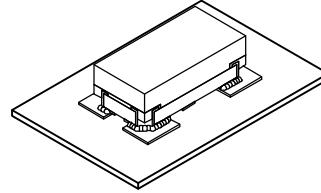

❖ Recommended Soldering Pattern (Units : mm; Tolerance: ± 0.1)

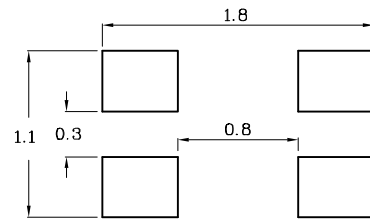

❖ Tape Specification (Units : mm)

❖ Reel Dimension (Units : mm)

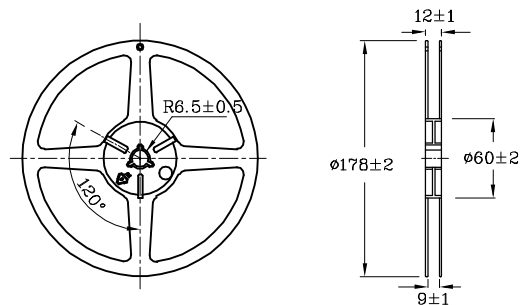
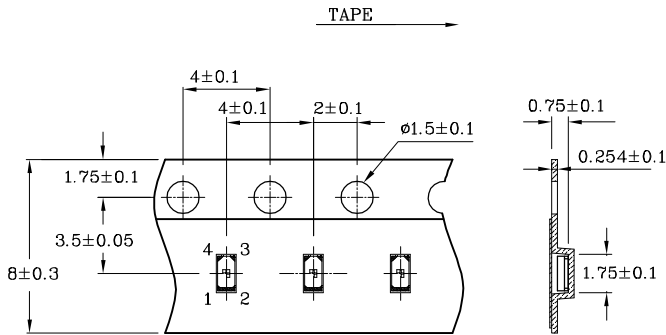

Remarks:

If special sorting is required (e.g. binning based on forward voltage, Luminous intensity / luminous flux, or wavelength), the typical accuracy of the sorting process is as follows:

1. Wavelength: +/-1nm
2. Luminous intensity / luminous flux: +/-15%
3. Forward Voltage: +/-0.1V

Note: Accuracy may depend on the sorting parameters.

PACKING & LABEL SPECIFICATIONS

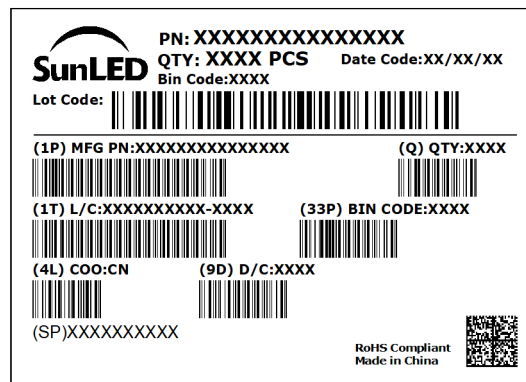
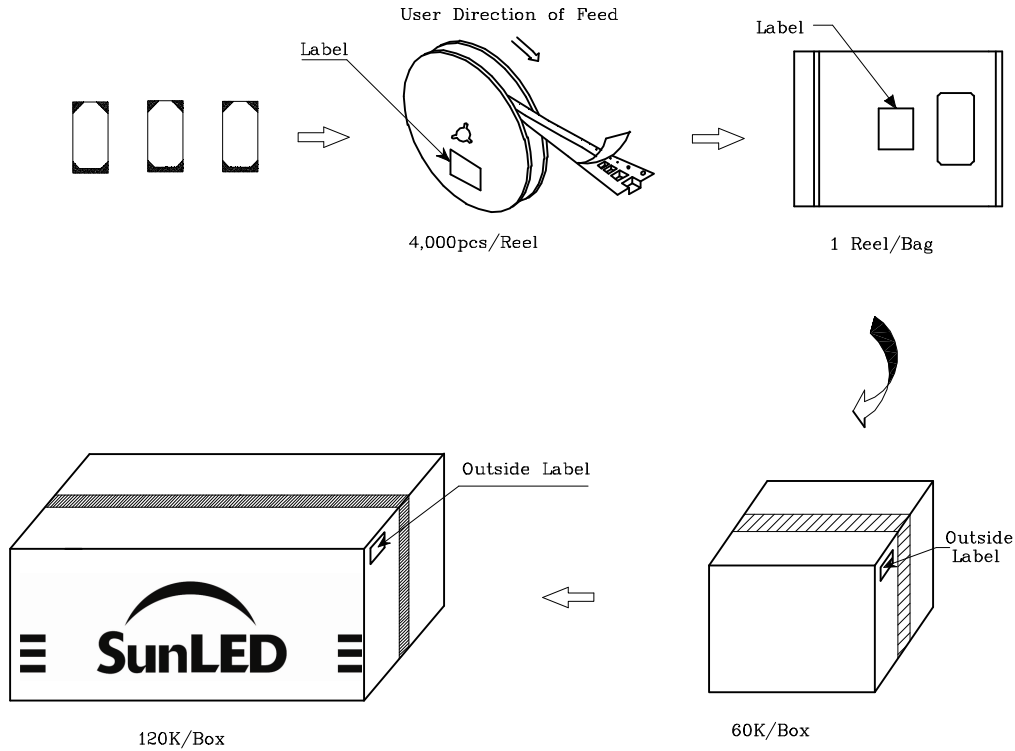

TERMS OF USE

1. Data presented in this document reflect statistical figures and should be treated as technical reference only.
2. Contents within this document are subject to improvement and enhancement changes without notice.
3. The product(s) in this document are designed to be operated within the electrical and environmental specifications indicated on the datasheet.
User accepts full risk and responsibility when operating the product(s) beyond their intended specifications.
4. The product(s) described in this document are intended for electronic applications in which a person's life is not reliant upon the LED. Please consult with a SunLED representative for special applications where the LED may have a direct impact on a person's life.
5. The contents within this document may not be altered without prior consent by SunLED.
6. Additional technical notes are available at <https://www.SunLEDusa.com/TechnicalNotes.asp>