

Data sheet | Item number: 765-1205/100-000

8-channel digital input/output; EtherCAT; DC 24 V / 2.0 A; 8xM8 connection;  
SlimLine

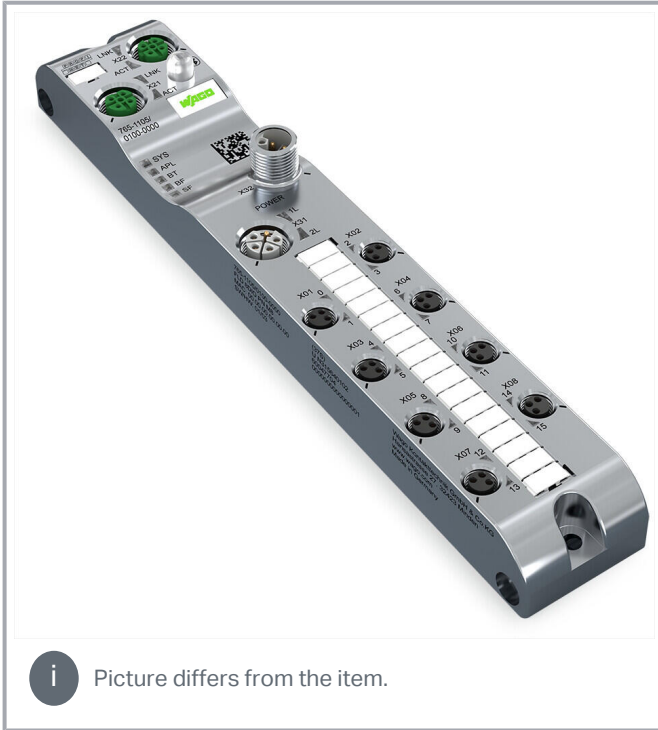

[www.wago.com/765-1205/100-000](http://www.wago.com/765-1205/100-000)



*i* Picture differs from the item.

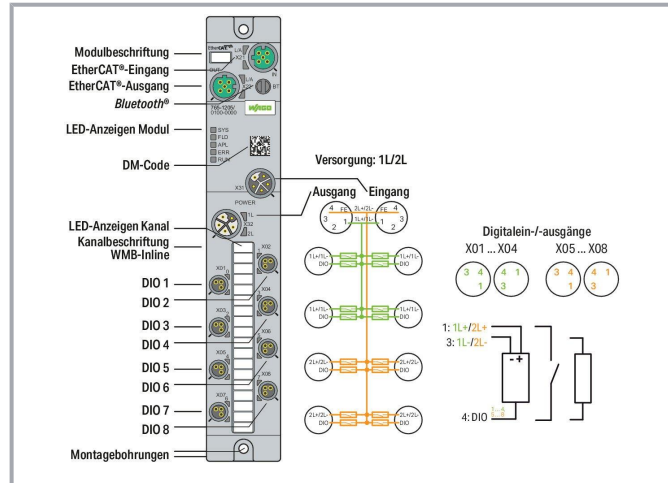

## Data

### Technical data

### Fieldbus

Communication	EtherCAT® AoE, EoE, FoE
Connection technology: communication/fieldbus	2 x D-coded M12; 4-pole
Interface standard	10BASE-T/100BASE-TX; potential-free
Autonegotiation; autocrossover	yes

### Device functions

Parameter	Input filter Output current Temperature
-----------	---

Subject to changes. Please also observe the further product documentation!

WAGO GmbH & Co. KG  
Hansastr. 27  
32423 Minden  
Phone: +49571 887-0 | Fax: +49571 887-169  
Email: [info.de@wago.com](mailto:info.de@wago.com) | Web: [www.wago.com](http://www.wago.com)

Do you have any questions about our products?  
We are always happy to take your call at +49 (571) 887-44222.



Diagnostics	Undervoltage; Overcurrent; Overload; Overtemperature
Device functions	Bluetooth® Bluetooth® OPC UA Server
Visualization	Web server Android/iOS app Webserver

## Digital inputs/outputs

Number of digital inputs	8
Number of digital outputs	8
Connection technology: inputs/outputs	8 x M8; 3-pole
Signal type (voltage)	24 VDC
Input characteristic	High-side switching
Input filter	0.2 ... 20 ms
Input characteristic	Type 3, per IEC 61131-2
Output current (per channel)	2 A (typ.) for DO
Supply current per port	1L/2L: 4 A (max.)

## Supply (module)

Connection technology: supply	2 x L-coded M12; 5-pole
Supply voltage	24 VDC (18 ... 31.2 V); 1L/2L
Current consumption (max.)	16000 mA
Current consumption (note)	per supply line; overload- and short-circuit-protected
Reverse voltage protection	Yes

## Physical data

Width	35 mm / 1.378 inches
Height	30 mm / 1.181 inches
Depth	210 mm / 8.268 inches

## Mechanical Data

Weight	390 g
Conformity marking	CE

## Environmental requirements

Ambient temperature (operation)	-25 ... +70 °C
---------------------------------	----------------

Subject to changes. Please also observe the further product documentation!

Ambient temperature (storage)	-40 ... +80 °C
Protection type	IP67
Protection class	III per EN 61140, IEC 61140, VDE 0140-1
Operating altitude	0 ... 2000 m / 0 ... 6562 ft
Pollution degree	3 (EN 60664-1)
Overvoltage category	II (EN 60664-1)
Relative humidity (without condensation)	95 %
Vibration resistance	5g per IEC 60068-2-6
Shock resistance	Short-term: 50g/11 ms/half-sine per IEC 60068-2-27; Long-term: 30g/6 ms/half-sine per IEC 60068-2-29
EMC immunity to interference	per EN 61000-6-2
EMC emission of interference	per EN 61000-6-4

### Commercial data



ETIM 8.0	EC001599
ETIM 7.0	EC001599
PU (SPU)	1 pcs
Packaging type	BOX
Country of origin	DE
GTIN	4066966063059
Customs tariff number	85371098990

### Environmental Product Compliance

RoHS Compliance Status	Compliant, No Exemption
------------------------	-------------------------

### Required accessories

#### Marking accessories

Marking strip		
	<b>Item no.: 2009-110</b> Marking strips; for Smart Printer; on reel; not stretchable; plain; snap-on type; white	<a href="http://www.wago.com/2009-110">www.wago.com/2009-110</a>
Marker		
	<b>Item no.: 2009-115</b> WMB-Inline; for Smart Printer; 1500 pieces on roll; stretchable 5 - 5.2 mm; plain; snap-on type; white	<a href="http://www.wago.com/2009-115">www.wago.com/2009-115</a>



#### Tool

Assembly tool		
	<b>Item no.: 206-701</b> Torque wrench M8 and M12; Assembly kit	<a href="http://www.wago.com/206-701">www.wago.com/206-701</a>

Subject to changes. Please also observe the further product documentation!

## Cover









## Cover

	<b>Item no.: 756-8102</b> M12 protective cap; for unused sockets	<a href="http://www.wago.com/756-8102">www.wago.com/756-8102</a>
	<b>Item no.: 756-8103</b> M12 protective cap; for unused plugs	<a href="http://www.wago.com/756-8103">www.wago.com/756-8103</a>
	<b>Item no.: 756-8101</b> M8 protective cap; for unused sockets	<a href="http://www.wago.com/756-8101">www.wago.com/756-8101</a>











## Optional accessories

## Cables and pluggable connectors

## Sensor/actuator cable

	<b>Item no.: 756-5501/030-020</b> Sensor/Actuator cable; M12A socket; straight; M8 plug; straight; 3-pole; Length: 2 m	<a href="http://www.wago.com/756-5501/030-020">www.wago.com/756-5501/030-020</a>
	<b>Item no.: 756-5502/030-010</b> Sensor/Actuator cable; M12A socket; straight; M8 plug; angled; 3-pole; Length: 1 m	<a href="http://www.wago.com/756-5502/030-010">www.wago.com/756-5502/030-010</a>
	<b>Item no.: 756-5502/030-020</b> Sensor/Actuator cable; M12A socket; straight; M8 plug; angled; 3-pole; Length: 2 m	<a href="http://www.wago.com/756-5502/030-020">www.wago.com/756-5502/030-020</a>
	<b>Item no.: 756-5503/030-010</b> Sensor/Actuator cable; M12A socket; angled; M8 plug; straight; 3-pole; Length: 1 m	<a href="http://www.wago.com/756-5503/030-010">www.wago.com/756-5503/030-010</a>
	<b>Item no.: 756-5503/030-020</b> Sensor/Actuator cable; M12A socket; angled; M8 plug; straight; 3-pole; Length: 2 m	<a href="http://www.wago.com/756-5503/030-020">www.wago.com/756-5503/030-020</a>
	<b>Item no.: 756-5111/030-015</b> Sensor/Actuator cable; M8 plug; straight; 3-pole; Length: 1.5 m	<a href="http://www.wago.com/756-5111/030-015">www.wago.com/756-5111/030-015</a>
	<b>Item no.: 756-5111/030-050</b> Sensor/Actuator cable; M8 plug; straight; 3-pole; Length: 5 m	<a href="http://www.wago.com/756-5111/030-050">www.wago.com/756-5111/030-050</a>
	<b>Item no.: 756-5111/030-100</b> Sensor/Actuator cable; M8 plug; straight; 3-pole; Length: 10 m	<a href="http://www.wago.com/756-5111/030-100">www.wago.com/756-5111/030-100</a>
	<b>Item no.: 756-5112/030-100</b> Sensor/Actuator cable; M8 plug; angled; 3-pole; Length: 10 m	<a href="http://www.wago.com/756-5112/030-100">www.wago.com/756-5112/030-100</a>

Subject to changes. Please also observe the further product documentation!

	<p><b>Item no.: 756-5112/030-015</b>                  Sensor/Actuator cable; M8 plug; angled; 3-pole; Length: 1.5 m</p>	<p><a href="http://www.wago.com/756-5112/030-015">www.wago.com/756-5112/030-015</a></p>
	<p><b>Item no.: 756-5112/030-050</b>                  Sensor/Actuator cable; M8 plug; angled; 3-pole; Length: 5 m</p>	<p><a href="http://www.wago.com/756-5112/030-050">www.wago.com/756-5112/030-050</a></p>
	<p><b>Item no.: 756-5201/030-010</b>                  Sensor/Actuator cable; M8 socket; straight; M8 plug; straight; 3-pole; Length: 1 m</p>	<p><a href="http://www.wago.com/756-5201/030-010">www.wago.com/756-5201/030-010</a></p>
	<p><b>Item no.: 756-5201/030-020</b>                  Sensor/Actuator cable; M8 socket; straight; M8 plug; straight; 3-pole; Length: 2 m</p>	<p><a href="http://www.wago.com/756-5201/030-020">www.wago.com/756-5201/030-020</a></p>
	<p><b>Item no.: 756-5202/030-020</b>                  Sensor/Actuator cable; M8 socket; straight; M8 plug; angled; 3-pole; Length: 2 m</p>	<p><a href="http://www.wago.com/756-5202/030-020">www.wago.com/756-5202/030-020</a></p>
	<p><b>Item no.: 756-5202/030-010</b>                  Sensor/Actuator cable; M8 socket; straight; M8 plug; angled; 3-pole; Length: 1 m</p>	<p><a href="http://www.wago.com/756-5202/030-010">www.wago.com/756-5202/030-010</a></p>
	<p><b>Item no.: 756-5203/030-010</b>                  Sensor/Actuator cable; M8 socket; angled; M8 plug; straight; 3-pole; Length: 1 m</p>	<p><a href="http://www.wago.com/756-5203/030-010">www.wago.com/756-5203/030-010</a></p>
	<p><b>Item no.: 756-5203/030-020</b>                  Sensor/Actuator cable; M8 socket; angled; M8 plug; straight; 3-pole; Length: 2 m</p>	<p><a href="http://www.wago.com/756-5203/030-020">www.wago.com/756-5203/030-020</a></p>
	<p><b>Item no.: 756-5204/030-020</b>                  Sensor/Actuator cable; M8 socket; angled; M8 plug; angled; 3-pole; Length: 2 m</p>	<p><a href="http://www.wago.com/756-5204/030-020">www.wago.com/756-5204/030-020</a></p>
	<p><b>Item no.: 756-5204/030-010</b>                  Sensor/Actuator cable; M8 socket; angled; M8 plug; angled; 3-pole; Length: 1 m</p>	<p><a href="http://www.wago.com/756-5204/030-010">www.wago.com/756-5204/030-010</a></p>
	<p><b>Item no.: 756-5501/030-010</b>                  Sensor/Actuator cable; M12A socket; straight; M8 plug; straight; 3-pole; Length: 1 m</p>	<p><a href="http://www.wago.com/756-5501/030-010">www.wago.com/756-5501/030-010</a></p>
	<p><b>Item no.: 756-5504/030-010</b>                  Sensor/Actuator cable; M12A socket; angled; M8 plug; angled; 3-pole; Length: 1 m</p>	<p><a href="http://www.wago.com/756-5504/030-010">www.wago.com/756-5504/030-010</a></p>
	<p><b>Item no.: 756-5504/030-020</b>                  Sensor/Actuator cable; M12A socket; angled; M8 plug; angled; 3-pole; Length: 2 m</p>	<p><a href="http://www.wago.com/756-5504/030-020">www.wago.com/756-5504/030-020</a></p>

Configurable connectors

Subject to changes. Please also observe the further product documentation!



**Item no.: 756-9102/030-000**  
Fitted pluggable connector; 3-pole; M8 plug, straight; IDC technology

[www.wago.com/756-9102/030-000](http://www.wago.com/756-9102/030-000)



**Item no.: 756-9105/030-000**  
Fitted pluggable connector; 3-pole; M8 plug, right angle; IDC technology

[www.wago.com/756-9105/030-000](http://www.wago.com/756-9105/030-000)



**Item no.: 756-9711/050-000**  
Fitted pluggable connector; 5-pole, shielded; M12 socket, straight; IDC technology

[www.wago.com/756-9711/050-000](http://www.wago.com/756-9711/050-000)



**Item no.: 756-9701/050-000**  
Fitted pluggable connector; 5-pole, shielded; M12 plug, straight; IDC technology

[www.wago.com/756-9701/050-000](http://www.wago.com/756-9701/050-000)

#### Configurable shielded connectors



**Item no.: 756-9501/060-000**  
Fitted pluggable connector; 4-pole, shielded; M12 plug, straight, D-coded; Spring

[www.wago.com/756-9501/060-000](http://www.wago.com/756-9501/060-000)



**Item no.: 756-9501/040-000**  
Accessories; M12 plug, right angle; 4-pole

[www.wago.com/756-9501/040-000](http://www.wago.com/756-9501/040-000)

#### Power cable



**Item no.: 756-3501/050-075**  
Power cable; M12L socket; straight; 5-pole; Length: 7.5 m

[www.wago.com/756-3501/050-075](http://www.wago.com/756-3501/050-075)



**Item no.: 756-3501/050-100**  
Power cable; M12L socket; straight; 5-pole; Length: 10 m

[www.wago.com/756-3501/050-100](http://www.wago.com/756-3501/050-100)



**Item no.: 756-3501/050-150**  
Power cable; M12L socket; straight; 5-pole; Length: 15 m

[www.wago.com/756-3501/050-150](http://www.wago.com/756-3501/050-150)



**Item no.: 756-3501/050-050**  
Power cable; M12L socket; straight; 5-pole; Length: 5 m













[www.wago.com/756-3501/050-050](http://www.wago.com/756-3501/050-050)















**Item no.: 756-3502/050-050**  
Power cable; M12L socket; angled; 5-pole; Length: 5 m

[www.wago.com/756-3502/050-050](http://www.wago.com/756-3502/050-050)

Subject to changes. Please also observe the further product documentation!

	<b>Item no.: 756-3502/050-150</b> Power cable; M12L socket; angled; 5-pole; Length: 15 m	<a href="http://www.wago.com/756-3502/050-150">www.wago.com/756-3502/050-150</a>
	<b>Item no.: 756-3502/050-075</b> Power cable; M12L socket; angled; 5-pole; Length: 7.5 m	<a href="http://www.wago.com/756-3502/050-075">www.wago.com/756-3502/050-075</a>
	<b>Item no.: 756-3502/050-100</b> Power cable; M12L socket; angled; 5-pole; Length: 10 m	<a href="http://www.wago.com/756-3502/050-100">www.wago.com/756-3502/050-100</a>
	<b>Item no.: 756-3503/050-075</b> Power cable; M12L plug; straight; 5-pole; Length: 7.5 m	<a href="http://www.wago.com/756-3503/050-075">www.wago.com/756-3503/050-075</a>
	<b>Item no.: 756-3503/050-150</b> Power cable; M12L plug; straight; 5-pole; Length: 15 m	<a href="http://www.wago.com/756-3503/050-150">www.wago.com/756-3503/050-150</a>
	<b>Item no.: 756-3503/050-100</b> Power cable; M12L plug; straight; 5-pole; Length: 10 m	<a href="http://www.wago.com/756-3503/050-100">www.wago.com/756-3503/050-100</a>
	<b>Item no.: 756-3505/050-003</b> Power cable; M12L socket; straight; M12L plug; straight; 5-pole; Length: 0.3 m	<a href="http://www.wago.com/756-3505/050-003">www.wago.com/756-3505/050-003</a>
	<b>Item no.: 756-3505/050-005</b> Power cable; M12L socket; straight; M12L plug; straight; 5-pole; Length: 0.5 m	<a href="http://www.wago.com/756-3505/050-005">www.wago.com/756-3505/050-005</a>
	<b>Item no.: 756-3505/050-020</b> Power cable; M12L socket; straight; M12L plug; straight; 5-pole; Length: 2 m	<a href="http://www.wago.com/756-3505/050-020">www.wago.com/756-3505/050-020</a>
	<b>Item no.: 756-3505/050-010</b> Power cable; M12L socket; straight; M12L plug; straight; 5-pole; Length: 1 m	<a href="http://www.wago.com/756-3505/050-010">www.wago.com/756-3505/050-010</a>
	<b>Item no.: 756-3505/050-050</b> Power cable; M12L socket; straight; M12L plug; straight; 5-pole; Length: 5 m	<a href="http://www.wago.com/756-3505/050-050">www.wago.com/756-3505/050-050</a>
	<b>Item no.: 756-3505/050-075</b> Power cable; M12L socket; straight; M12L plug; straight; 5-pole; Length: 7.5 m	<a href="http://www.wago.com/756-3505/050-075">www.wago.com/756-3505/050-075</a>

Subject to changes. Please also observe the further product documentation!

	<b>Item no.: 756-3505/050-100</b> Power cable; M12L socket; straight; M12L plug; straight; 5-pole; Length: 10 m	<a href="http://www.wago.com/756-3505/050-100">www.wago.com/756-3505/050-100</a>
	<b>Item no.: 756-3506/050-100</b> Power cable; M12L socket; angled; M12L plug; angled; 5-pole; Length: 10 m	<a href="http://www.wago.com/756-3506/050-100">www.wago.com/756-3506/050-100</a>
	<b>Item no.: 756-3506/050-075</b> Power cable; M12L socket; angled; M12L plug; angled; 5-pole; Length: 7.5 m	<a href="http://www.wago.com/756-3506/050-075">www.wago.com/756-3506/050-075</a>
	<b>Item no.: 756-3506/050-150</b> Power cable; M12L socket; angled; M12L plug; angled; 5-pole; Length: 15 m	<a href="http://www.wago.com/756-3506/050-150">www.wago.com/756-3506/050-150</a>
	<b>Item no.: 756-3501/050-020</b> Power cable; M12L socket; straight; 5-pole; Length: 2 m	<a href="http://www.wago.com/756-3501/050-020">www.wago.com/756-3501/050-020</a>
	<b>Item no.: 756-3502/050-020</b> Power cable; M12L socket; angled; 5-pole; Length: 2 m	<a href="http://www.wago.com/756-3502/050-020">www.wago.com/756-3502/050-020</a>
	<b>Item no.: 756-3503/050-020</b> Power cable; M12L plug; straight; 5-pole; Length: 2 m	<a href="http://www.wago.com/756-3503/050-020">www.wago.com/756-3503/050-020</a>
	<b>Item no.: 756-3503/050-050</b> Power cable; M12L plug; straight; 5-pole; Length: 5 m	<a href="http://www.wago.com/756-3503/050-050">www.wago.com/756-3503/050-050</a>
	<b>Item no.: 756-3504/050-020</b> Power cable; M12L plug; angled; 5-pole; Length: 2 m	<a href="http://www.wago.com/756-3504/050-020">www.wago.com/756-3504/050-020</a>
	<b>Item no.: 756-3504/050-050</b> Power cable; M12L plug; angled; 5-pole; Length: 5 m	<a href="http://www.wago.com/756-3504/050-050">www.wago.com/756-3504/050-050</a>
	<b>Item no.: 756-3504/050-075</b> Power cable; M12L plug; angled; 5-pole; Length: 7.5 m	<a href="http://www.wago.com/756-3504/050-075">www.wago.com/756-3504/050-075</a>
	<b>Item no.: 756-3504/050-100</b> Power cable; M12L plug; angled; 5-pole; Length: 10 m	<a href="http://www.wago.com/756-3504/050-100">www.wago.com/756-3504/050-100</a>

Subject to changes. Please also observe the further product documentation!





**Item no.:** 765-3504/050-150  
Power cable; M12L plug; angled; 5-pole; Length: 15 m

[www.wago.com/765-3504/050-150](http://www.wago.com/765-3504/050-150)



**Item no.:** 765-3505/050-150  
Power cable; M12L socket; straight; M12L plug; straight; 5-pole; Length: 15 m

[www.wago.com/765-3505/050-150](http://www.wago.com/765-3505/050-150)



**Item no.:** 765-3506/050-003  
Power cable; M12L socket; angled; M12L plug; angled; 5-pole; Length: 0.3 m

[www.wago.com/765-3506/050-003](http://www.wago.com/765-3506/050-003)



**Item no.:** 765-3506/050-005  
Power cable; M12L socket; angled; M12L plug; angled; 5-pole; Length: 0.5 m

[www.wago.com/765-3506/050-005](http://www.wago.com/765-3506/050-005)



**Item no.:** 765-3506/050-020  
Power cable; M12L socket; angled; M12L plug; angled; 5-pole; Length: 2 m

[www.wago.com/765-3506/050-020](http://www.wago.com/765-3506/050-020)



**Item no.:** 765-3506/050-010  
Power cable; M12L socket; angled; M12L plug; angled; 5-pole; Length: 1 m

[www.wago.com/765-3506/050-010](http://www.wago.com/765-3506/050-010)



**Item no.:** 765-3506/050-050  
Power cable; M12L socket; angled; M12L plug; angled; 5-pole; Length: 5 m

[www.wago.com/765-3506/050-050](http://www.wago.com/765-3506/050-050)

#### Adapter



**Item no.:** 765-9503/040-000  
Accessories; 4-pole

[www.wago.com/765-9503/040-000](http://www.wago.com/765-9503/040-000)



**Item no.:** 765-9504/040-000  
Accessories; 4-pole

[www.wago.com/765-9504/040-000](http://www.wago.com/765-9504/040-000)

#### ETHERNET/PROFINET cable



**Item no.:** 765-1202/060-200  
ETHERNET cable; M12D plug; angled; 4-pole; Length: 20 m

[www.wago.com/765-1202/060-200](http://www.wago.com/765-1202/060-200)



**Item no.:** 765-1201/060-100  
ETHERNET cable; M12D plug; straight; 4-pole; Length: 10 m

[www.wago.com/765-1201/060-100](http://www.wago.com/765-1201/060-100)

Subject to changes. Please also observe the further product documentation!



Item no.: 756-1201/060-050  
ETHERNET cable; M12D plug; straight; 4-pole; Length: 5 m

[www.wago.com/756-1201/060-050](http://www.wago.com/756-1201/060-050)



Item no.: 756-1203/060-050  
ETHERNET cable; M12D plug; straight; M12D plug; straight; 4-pole; Length: 5 m

[www.wago.com/756-1203/060-050](http://www.wago.com/756-1203/060-050)



Item no.: 756-1203/060-020  
ETHERNET cable; M12D plug; straight; M12D plug; straight; 4-pole; Length: 2 m

[www.wago.com/756-1203/060-020](http://www.wago.com/756-1203/060-020)



Item no.: 756-1202/060-020  
ETHERNET cable; M12D plug; angled; 4-pole; Length: 2 m

[www.wago.com/756-1202/060-020](http://www.wago.com/756-1202/060-020)



Item no.: 756-1201/060-200  
ETHERNET cable; M12D plug; straight; 4-pole; Length: 20 m

[www.wago.com/756-1201/060-200](http://www.wago.com/756-1201/060-200)



Item no.: 756-1204/060-050  
ETHERNET cable; M12D plug; angled; M12D plug; angled; 4-pole; Length: 5 m

[www.wago.com/756-1204/060-050](http://www.wago.com/756-1204/060-050)



Item no.: 756-1204/060-100  
ETHERNET cable; M12D plug; angled; M12D plug; angled; 4-pole; Length: 10 m

[www.wago.com/756-1204/060-100](http://www.wago.com/756-1204/060-100)



Item no.: 756-1204/060-200  
ETHERNET cable; M12D plug; angled; M12D plug; angled; 4-pole; Length: 20 m

[www.wago.com/756-1204/060-200](http://www.wago.com/756-1204/060-200)



Item no.: 756-1203/060-200  
ETHERNET cable; M12D plug; straight; M12D plug; straight; 4-pole; Length: 20 m

[www.wago.com/756-1203/060-200](http://www.wago.com/756-1203/060-200)



Item no.: 756-1203/060-100  
ETHERNET cable; M12D plug; straight; M12D plug; straight; 4-pole; Length: 10 m

[www.wago.com/756-1203/060-100](http://www.wago.com/756-1203/060-100)



Item no.: 756-1204/060-010  
ETHERNET cable; M12D plug; angled; M12D plug; angled; 4-pole; Length: 1 m

[www.wago.com/756-1204/060-010](http://www.wago.com/756-1204/060-010)



Item no.: 756-1204/060-030  
ETHERNET cable; M12D plug; angled; M12D plug; angled; 4-pole; Length: 3 m

[www.wago.com/756-1204/060-030](http://www.wago.com/756-1204/060-030)

Subject to changes. Please also observe the further product documentation!



**Item no.: 756-1204/060-020**  
ETHERNET cable; M12D plug; angled; M12D plug; angled; 4-pole; Length: 2 m

[www.wago.com/756-1204/060-020](http://www.wago.com/756-1204/060-020)



**Item no.: 756-1202/060-050**  
ETHERNET cable; M12D plug; angled; 4-pole; Length: 5 m

[www.wago.com/756-1202/060-050](http://www.wago.com/756-1202/060-050)



**Item no.: 756-1202/060-100**  
ETHERNET cable; M12D plug; angled; 4-pole; Length: 10 m

[www.wago.com/756-1202/060-100](http://www.wago.com/756-1202/060-100)



**Item no.: 756-1201/060-020**  
ETHERNET cable; M12D plug; straight; 4-pole; Length: 2 m

[www.wago.com/756-1201/060-020](http://www.wago.com/756-1201/060-020)

## Downloads

### Documentation

#### Manual

Product Manual 8-Channel Digital Input/Output; EtherCAT; 24 VDC / 2.0 A; 8xM8 Connection; SlimLine	V 2.0.0 2022 Jul 19	pdf 7.3 MB	Download
--	------------------------	---------------	----------

#### System Description

WAGO I/O System Field; General Product Information		pdf 1.0 MB	Download
--	--	---------------	----------

## Application Notes

### Application Note e!COCKPIT

e!COCKPIT Application Note EtherCAT IO-Field (a2022003) WAGO EtherCAT Master, EoE access with IO-Field devices	1.0.0 2023 Mar 23	pptx 2.2 MB	Download
---	----------------------	----------------	----------

## Runtime Software

### Firmware

0765-x2xx, EtherCat IO-Field WAGO_FW0765-x2xx_V01010021_IX04	V 04 2023 Feb 2	zip 1.6 MB	Download
---	--------------------	---------------	----------

Subject to changes. Please also observe the further product documentation!



## CAD/CAE-Data

### CAD data

2D/3D Models 765-1205/100-000	<a href="#">URL</a>	<a href="#">Download</a>
-------------------------------	---------------------	--------------------------

### CAE data

EPLAN Data Portal 765-1205/100-000	<a href="#">URL</a>	<a href="#">Download</a>
------------------------------------	---------------------	--------------------------

## Device Files

### Device Description File

Gerätebeschreibungsdateien 765-42xx, 765-12xx, EtherCAT	V1_1_0_17	zip 73.6 kB	<a href="#">Download</a>
---	-----------	----------------	--------------------------

## Environmental Product Compliance

### Compliance Search

Environmental Product Compliance 765-1205/100-000 8-channel digital input/output; EtherCAT; DC 24 V / 2.0 A; 8xM8 connection; SlimLine	<a href="#">URL</a>	<a href="#">Download</a>
---	---------------------	--------------------------

## Installation Notes

## Product family

**WAGO I/O System Field**  
[Show all products from the family](#)

Subject to changes. Please also observe the further product documentation!