

Figure 1.1. Physical Photo of the ATH10K1R25

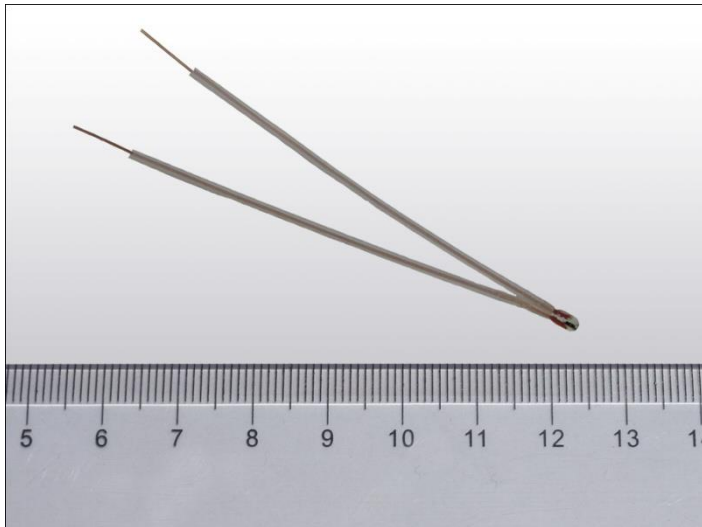

Figure 1.2. Physical Photo of the ATH10K1R25T70

### DESCRIPTIONS

The ATH10K1R25 series thermistor consists of three versions, ATH10K1R25 as shown in Figure 1.1, ATH10K1R25T70 shown in Figure 1.2 and ATH10K1R25T70S. The ATH10K1R25 has bare leads coated with copper, the ATH10K1R25T70S has the leads covered by high temperature plastic tubing and sealed by epoxy, while the ATH10K1R25T70 is the non-sealed version.

The ATH10K1R25 is of a high stability and high precision glass encapsulated thermistor. Compared to conventional epoxy encapsulated thermistors, ATH10K1R25 features a much wider temperature range, especially on the high end, much better long term stability, a smaller size, and a shorter response time. In addition, there are two insulation versions available, one of which comes with leads covered by high temperature plastic tubing, the ATH10K1R25T70, and the other one, the ATH10K1R25T70S, is sealed between the head and the tubing. They can work under temperatures as high as 140°C and the latter is liquid resistant.

The ATH10K1R25 series thermistors can be used to sense the temperatures for laser diodes, optical components, industrial process control, etc., where high temperature sensitivity, long term stability, and/or sensing high temperatures are required.

Figure 2, Figure 3 and Figure 4 show the mechanical dimensions of the ATH10K1R25, the ATH10K1R25T70 and the ATH10K1R25T70S respectively. All dimension units are millimeters.

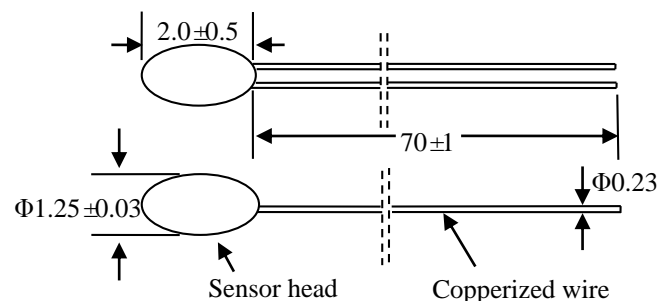

Figure 2. Side View of ATH10K1R25

### MAIN FEATURES

- Glass Encapsulated for Long Term Stability & Reliability
- High Resistance Accuracy: 1%
- Small Size:  $\phi 1.25\text{mm} \times 2.0\text{mm}$
- Wide Temp. Range:  $-40^\circ\text{C}$  to  $270^\circ\text{C}$
- 100 % Lead (Pb)-free and RoHS Compliant

### APPLICATIONS

Temperature sensing for laser diodes, optical components, industrial process control, etc., where high temperature sensitivity, long term stability, and/or high sensing temperatures are required.



Figure 3. Side View of ATH10K1R25T70



Figure 4. Side View of ATH10K1R25T70S

### SPECIFICATIONS

Parameter	Value
Nominal Resistance@ 25°C	10K ± 1%
β Value @ 25°C/50°C	3950K ± 1%
β Value @ 25°C/85°C	3990K ± 1%
R@25°C / R@50°C	2.771
R@25°C / R@85°C	9.271
Thermistor Diameter	1.25 ± 0.03mm
Thermistor Length	2.0 ± 0.5mm
Lead Diameter	0.23mm
Lead Length	70 ± 1mm
Dissipation Factor	≥ 1.0mW/°C
Insulation Resistance	50MΩ
Thermal Time Constant	2.39s (in still air) 1s (in water)

### APPLICATIONS

The thermistor ATH10K1R25, ATH10K1R25T70 or ATH10K1R25T70S can be used to sense solid block temperature with high stability and accuracy. The best way to mount the thermistor is to drill a hole on the object for which the temperature needs to be measured and regulated, and use thermal conductive epoxy to pot the thermistor inside the hole. The diameter of the hole should be 1.4 to 1.8mm and the depth should be 3 to 4mm. When a deeper hole is needed, drill a 2 stage hole to prevent epoxy bubbles trapped inside the deep hole which could cause temperature measurement errors. Figure 5 shows the section view of the 2 stage hole.

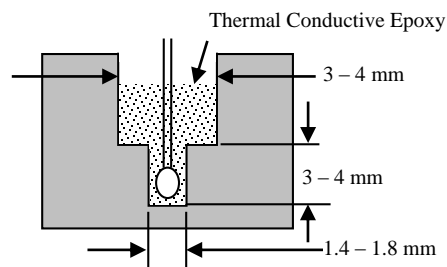

Figure 5. Section View of the 2 Stage Hole

The worst mounting result would be to have air bubbles trapped inside the thermistor mounting hole. These bubbles cause thermal sensing time delay and sensing temperature errors. To avoid the bubbles, in addition to drilling the 2 stage hole, use thin epoxy, vibrate the assembly before curing the epoxy, and cure the epoxy at high temperature, 80°C to 120°C, depending on the epoxy used and the maximum temperature the assembly components allow.

The thermistor lead wires are made of copperized alloy and there is no insulation coating on them. Therefore, when using bare leaded thermistors, make sure that they do not touch each other after mounting the thermistor.

Some thermal conductive epoxies are also electrically conductive and such epoxies should not be used for mounting the thermistors, since the lead wires are conductive and the epoxy would change the thermistor's resistance, thus causing temperature sensing errors.

Notice: Bare leaded and the non-sealed versions cannot be used in water or other liquid directly, since the lead wires would be corroded.

### CAUTIONS

1. Do not bend the thermistor leads at the location that is too close to the thermistors body, to avoid breaking the glass coating, as shown in Figure 6.1, Figure 6.2, and Figure 6.3 below. Only bend the leads at the location that is at least 2mm away from the thermistor body.

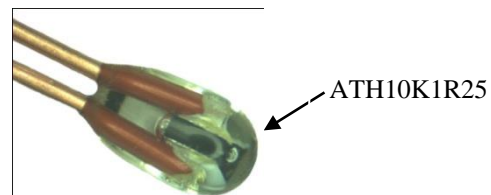

Figure 6.1. Bare Leaded Thermistor Head Photo

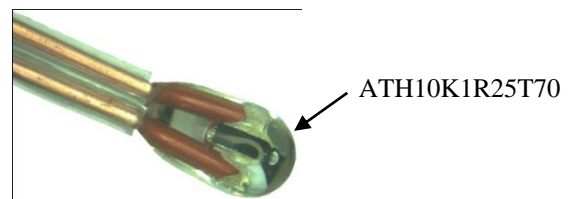

Figure 6.2. Tubing Leaded Non-sealed Thermistor Head Photo

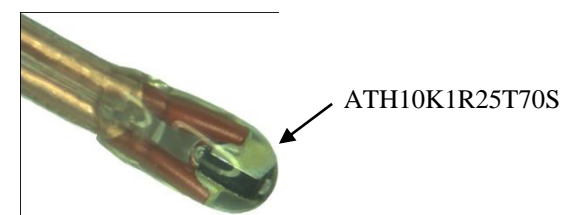

Figure 6.3. Tubing Leaded Sealed Thermistor Head Photo

2. Do not apply a large DC voltage across the thermistor in the temperature sensing circuit. The thermistor's self-heating temperature is about 1°C/mW. By injecting a 10μA current into the thermistor, it consumes 1mW and the self-heating temperature is about 1°C if the thermistor is placed in still air at a normal room temperature. Therefore, the injection current onto the thermistor needs to be much lower than 10μA when the thermistor is placed in the air for high accuracy air temperature sensing applications. Injecting short current pulses into the thermistor is one of the ways to reduce the average current level on the thermistor in order to minimize the self-heating effect.
3. Handle the thermistor with care, do not use metal tools to hold the thermistor's body with excessive force, otherwise,



the glass body may crack, affecting its accuracy and stability.

### Thermistor Resistance

#### Beta Value ( $\beta$ )

A simple approximation for the relationship between the resistance and temperature for the ATH10K1R25 is to use an exponential approximation. This approximation is based on a simple curve fitting to experimental data and uses two points on a curve to determine the value of  $\beta$ . The equation relating resistance to temperature using  $\beta$  is:

$$R = Ae^{\frac{\beta}{T}}$$

Where:

- R = thermistor resistance at temp T,
- A = constant of equation,
- $\beta$  = beta, the material constant,
- T = thermistor temperature in °K (Kelvin),

To calculate  $\beta$  for any given temperature range, the following formula applies:

$$\beta = \frac{R_1 R_2 (T_1 - T_2)}{R_2 - R_1}$$

Where  $\beta$  is measured in K,  $R_{T1}$  is the resistance at  $T_1$ , while  $R_{T2}$  is the resistance at  $T_2$ .

$\beta$  can be used to compare the relative steepness of ATH10K1R25 curves. However, the value of  $\beta$  will vary depending on the temperatures used for calculating the value. For example, to calculate  $\beta$  for the temperature range of 25°C to 50°C:

$$T_1 = (25 + 273.15)^\circ\text{K} = 298.15^\circ\text{K},$$

$$T_2 = (50 + 273.15)^\circ\text{K} = 323.15^\circ\text{K},$$

$$R_{T1} = 10\text{K}\Omega,$$

$$R_{T2} = 3.6085\text{K}\Omega;$$

This value of  $\beta$  would be referenced as  $\beta_{25^\circ\text{C}/50^\circ\text{C}}$ , and calculated as:

$$\beta_{25^\circ\text{C}/50^\circ\text{C}} = \ln(10/3.6085) / (1/298.15 - 1/323.15) = 3950\text{K};$$

By using the same formula,  $\beta_{25^\circ\text{C}/85^\circ\text{C}}$ , will be:

$$\beta_{25^\circ\text{C}/85^\circ\text{C}} = \ln(10/1.0786) / (1/298.15 - 1/358.15) = 3990\text{K}.$$

When using the  $\beta$  value to compare 2 thermistors, make sure that the  $\beta$  values are calculated based on the same 2 temperature points.

#### Temperature Coefficient of Resistance ( $\alpha$ )

Another way to characterize the R-T curve of the ATH10K1R25 is to use the slope of the resistance versus temperature (R/T) curve at one temperature. By definition, the resistance slope vs. temperature is given by:

$$\alpha = \frac{1}{R} \frac{dR}{dT}$$

Where T is the temperature in °C or °K, R is the resistance at temperature T.

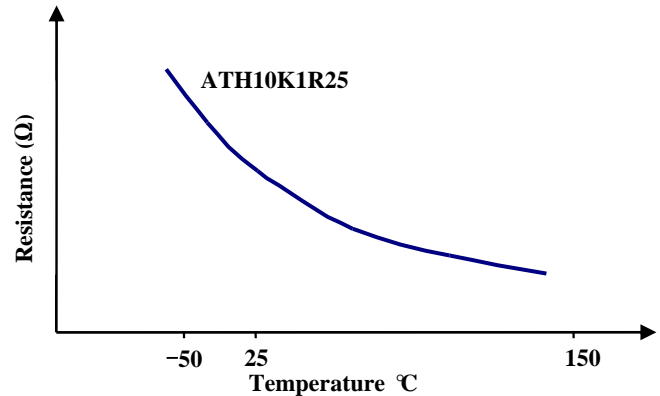

Figure 7. Resistance vs. Temperature for ATH10K1R25

As shown in Figure 7, the steepest position of the ATH10K1R25 curve is at colder temperatures.

The temperature coefficient is one method that can be used for comparing the relative steepness of the curves. It is highly recommended to compare the temperature coefficient at the same temperature because  $\alpha$  varies widely over the operating temperature range.

#### Resistance Ratio (Slope)

The resistance ratio, or slope, for thermistors is defined as the ratio of the resistance at one temperature to the resistance at a higher temperature. As with resistance ratios, this method will vary depending on the temperatures used for calculating the value. This method can also be used to compare the relative steepness of two curves. There is no industry standard for the two temperatures that are used to calculate the ratio, we can select two common temperatures from the table below, for example, 25°C and 50°C, then the result of this calculation is:  $R@25^\circ\text{C} / R@50^\circ\text{C}$ , will be:

$$R@25^\circ\text{C} / R@50^\circ\text{C} = 10/3.6085 = 2.771;$$

And this calculation:  $R@25^\circ\text{C}/R@85^\circ\text{C}$ , will be:  $R@25^\circ\text{C} / R@85^\circ\text{C} = 10/1.0786 = 9.271$ .



Steinhart-Hart Thermistor Equation

The Steinhart-Hart Equation is an empirically derived polynomial formula which does best in describing the relationship between the resistance and the temperature of the ATH10K1R25, which is much more accurate than β method. To solve for a temperature when resistance is known, yields the following equation:

R = e^{a/T + b/T^2 + c/T^3}

Where:

- T = temperature in °K (Kelvin),
a, b and c are equation constants,
R = resistance in Ω at temp T;

To solve for resistance when the temperature is known, the form of the equation is:

R = e^{[(-x + sqrt(x^2 + psi^3)/2)]^{1/3} + [(-x - sqrt(x^2 + psi^3)/2)]^{1/3}}

Where:

x = a - 1/T, psi = b/c

The a, b and c constants can be calculated for either a thermistor material or for individual values of the thermistors within a material type. To solve for the constants, three sets of data must be used. Normally, for a temperature range, the low end, middle end and high end values are used to calculate the constants, resulting in the best fit for the equation over the range. Using the Steinhart-Hart equation allows for accuracy as good as ±0.001°C over a 100°C temperature span.



Resistance Temperature Characteristics

Temp.	Resistance	Temp.	Resistance	Temp.	Resistance	Temp.	Resistance	Temp.	Resistance
°C	KΩ	°C	KΩ	°C	KΩ	°C	KΩ	°C	KΩ
-40	342.55	7	23.041	54	3.1061	101	0.6639	148	0.1957
-39	320.26	8	21.935	55	2.9940	102	0.6463	149	0.1912
-38	299.57	9	20.908	56	2.8858	103	0.6280	150	0.1869
-37	280.36	10	19.921	57	2.7816	104	0.6102	151	0.1786
-36	262.51	11	18.984	58	2.6834	105	0.5932	152	0.1745
-35	245.92	12	18.100	59	2.5871	106	0.5766	153	0.1706
-34	230.49	13	17.264	60	2.4969	107	0.5605	154	0.1667
-33	216.13	14	16.471	61	2.4086	108	0.5449	155	0.1629
-32	202.77	15	15.717	62	2.3244	109	0.5229	156	0.1593
-31	190.31	16	15.004	63	2.2441	110	0.5153	157	0.1557
-30	178.71	17	14.327	64	2.1658	111	0.5013	158	0.1523
-29	167.89	18	13.683	65	2.0915	112	0.4877	159	0.1489
-28	157.80	19	13.073	66	2.0202	113	0.4745	160	0.1456
-27	148.37	20	12.494	67	1.9515	114	0.4617	161	0.1424
-26	139.58	21	11.943	68	1.8854	115	0.4493	162	0.1393
-25	131.36	22	11.419	69	1.8219	116	0.4371	163	0.1363
-24	123.68	23	10.923	70	1.7610	117	0.4256	164	0.1333
-23	116.49	24	10.449	71	1.7022	118	0.4141	165	0.1304
-22	109.78	25	10.000	72	1.6457	119	0.4032	166	0.1276
-21	103.49	26	9.5730	73	1.5916	120	0.3927	167	0.1249
-20	97.597	27	9.1658	74	1.5393	121	0.3823	168	0.1222
-19	92.091	28	8.7783	75	1.4891	122	0.3724	169	0.1196
-18	86.912	29	8.4085	76	1.4406	123	0.3628	170	0.1171
-17	82.063	30	8.0586	77	1.3941	124	0.3535	171	0.1146
-16	77.525	31	7.7224	78	1.3494	125	0.3445	172	0.1122
-15	73.259	32	7.4041	79	1.3063	126	0.3356	173	0.1099
-14	69.245	33	7.0995	80	1.2648	127	0.3271	174	0.1076
-13	65.485	34	6.8109	81	1.2246	128	0.3189	175	0.1054
-12	61.958	35	6.5341	82	1.1861	129	0.3109	176	0.1032
-11	58.626	36	6.2711	83	1.1488	130	0.3031	177	0.1011
-10	55.508	37	6.0180	84	1.1131	131	0.2955	178	0.0990
-9	52.566	38	5.7788	85	1.0786	132	0.2882	179	0.0970
-8	49.799	39	5.5496	86	1.0453	133	0.2811	180	0.0950
-7	47.208	40	5.3302	87	1.0132	134	0.2742	181	0.0931
-6	44.753	41	5.1207	88	0.9823	135	0.2675	182	0.0912
-5	42.454	42	4.9211	89	0.9524	136	0.2609	183	0.0894
-4	40.273	43	4.7315	90	0.9236	137	0.2546	184	0.0876
-3	38.228	44	4.5478	91	0.8957	138	0.2484	185	0.0859
-2	36.281	45	4.3740	92	0.8690	139	0.2425	186	0.0842
-1	34.407	46	4.2082	93	0.8431	140	0.2367	187	0.0825
0	32.738	47	4.0484	94	0.8181	141	0.2311	188	0.0809
1	31.104	48	3.8944	95	0.7938	142	0.2256	189	0.0793
2	29.568	49	3.7485	96	0.7705	143	0.2203	190	0.0778
3	28.109	50	3.6085	97	0.7481	144	0.2151	191	0.0763
4	26.729	51	3.4764	98	0.7262	145	0.2100	192	0.0748
5	25.428	52	3.3464	99	0.7051	146	0.2052	193	0.0733
6	24.205	53	3.2243	100	0.6825	147	0.2004	194	0.0719



Temp.	Resistance	Temp.	Resistance	Temp.	Resistance	Temp.	Resistance	Temp.	Resistance
°C	KΩ	°C	KΩ	°C	KΩ	°C	KΩ	°C	KΩ
195	0.0706	211	0.0524	227	0.0396	243	0.0304	259	0.0237
196	0.0692	212	0.0514	228	0.0389	244	0.0299	260	0.0234
197	0.0679	213	0.0505	229	0.0382	245	0.0294	261	0.0230
198	0.0666	214	0.0496	230	0.0376	246	0.0290	262	0.0227
199	0.0654	215	0.0487	231	0.0370	247	0.0285	263	0.0223
200	0.0641	216	0.0479	232	0.0364	248	0.0280	264	0.0220
201	0.0630	217	0.0470	233	0.0358	249	0.0276	265	0.0217
202	0.0618	218	0.0462	234	0.0352	250	0.0272	266	0.0214
203	0.0606	219	0.0454	235	0.0346	251	0.0268	267	0.0210
204	0.0595	220	0.0446	236	0.0340	252	0.0264	268	0.0207
205	0.0584	221	0.0439	237	0.0335	253	0.0260	269	0.0204
206	0.0574	222	0.0431	238	0.0329	254	0.0256	270	0.0201
207	0.0563	223	0.0424	239	0.0324	255	0.0252		
208	0.0553	224	0.0416	240	0.0319	256	0.0248		
209	0.0543	225	0.0409	241	0.0314	257	0.0244		
210	0.0533	226	0.0402	242	0.0309	258	0.0241		

ORDERING INFORMATION

Table 1. Part Number of the Thermistor

Part #	Description
ATH10K1R25	High stability miniature thermistor with bare leads
ATH10K1R25T70	High stability miniature thermistor with leads covered by high temperature plastic tubing
ATH10K1R25T70S	High stability miniature thermistor with leads covered by high temperature plastic tubing and sealed by epoxy



AGING TEST DATA

I. High Temp. Action

<b>Purpose</b>	Test the durability of the thermistor in load voltage circuit and 120 °C																				
<b>Method</b>	Connect the circuit according to the figure below. The thermistor works in -30 °C for 240 hrs. During this process, measure the voltage of the two ends of thermistor every 24 hrs and then calculate the resistance value based on differential pressure principle. Compare the changing rate of this point before and after the test.																				
<b>Test data</b>																					
<b>No.</b>	<b>0h</b>	<b>24h</b>	<b>48h</b>	<b>72h</b>	<b>96h</b>	<b>120h</b>	<b>Change rate</b>					<b>144h</b>	<b>168h</b>	<b>192h</b>	<b>216h</b>	<b>240h</b>	<b>Change rate</b>				
<b>Temp. Field</b>	<b>Mv</b>						<b>δ1</b>	<b>δ2</b>	<b>δ3</b>	<b>δ4</b>	<b>δ5</b>						<b>δ5</b>	<b>δ5</b>	<b>δ7</b>	<b>δ8</b>	<b>δ5</b>
1	255	256	257	257	258	258	0.39	0.78	0.78	1.18	1.18	258	258	259	258	258	1.18	1.18	1.57	1.18	1.18
2	254	256	257	257	257	257	0.79	1.18	1.18	1.18	1.18	258	258	258	258	258	1.57	1.57	1.57	1.57	1.57
3	258	260	261	261	261	261	0.78	1.16	1.16	1.16	1.16	261	261	261	261	261	1.16	1.16	1.16	1.16	1.16
4	257	259	261	260	261	261	0.78	1.56	1.17	1.56	1.56	261	261	261	261	261	1.56	1.56	1.56	1.56	1.56
5	254	255	256	256	257	257	0.39	0.79	0.79	1.18	1.18	257	257	258	258	258	1.18	1.18	1.57	1.57	1.57
6	253	255	256	256	256	256	0.79	1.19	1.19	1.19	1.19	256	257	256	257	257	1.19	1.58	1.19	1.58	1.58
7	256	256	257	257	258	258	0.00	0.39	0.39	0.78	0.78	258	259	259	259	259	0.78	1.17	1.17	1.17	1.17
8	259	259	260	261	261	262	0.00	0.39	0.77	0.77	1.16	262	262	263	263	263	1.16	1.16	1.54	1.54	1.54
9	258	259	259	260	260	260	0.39	0.39	0.78	0.78	0.78	260	260	260	260	260	0.78	0.78	0.78	0.78	0.78
10	255	257	259	258	258	258	0.78	1.57	1.18	1.18	1.18	258	258	258	258	258	1.18	1.18	1.18	1.18	1.18
11	254	256	256	256	257	257	0.79	0.79	0.79	1.18	1.18	257	257	257	257	257	1.18	1.18	1.18	1.18	1.18
12	257	258	259	259	259	259	0.39	0.78	0.78	0.78	0.78	259	259	259	259	259	0.78	0.78	0.78	0.78	0.78
13	256	258	258	258	259	259	0.78	0.78	0.78	1.17	1.17	259	259	259	259	259	1.17	1.17	1.17	1.17	1.17
14	258	258	259	259	260	260	0.00	0.39	0.39	0.78	0.78	260	260	260	260	260	0.78	0.78	0.78	0.78	0.78



No.	0h	24h	48h	72h	96h	120h	Change rate					144h	168h	192h	216h	240h	Change rate				
							$\delta 1$	$\delta 2$	$\delta 3$	$\delta 4$	$\delta 5$						$\delta 5$	$\delta 5$	$\delta 7$	$\delta 8$	$\delta 5$
Temp. Field	Mv																				
15	258	260	261	261	260	261	0.78	1.16	1.16	0.78	1.16	261	261	261	261	261	1.16	1.16	1.16	1.16	1.16
16	256	257	257	258	258	258	0.39	0.39	0.78	0.78	0.78	258	258	258	258	258	0.78	0.78	0.78	0.78	0.78
17	257	259	260	260	260	259	0.78	1.17	1.17	1.17	0.78	259	259	260	259	259	0.78	0.78	1.17	0.78	0.78
18	256	258	259	259	260	260	0.78	1.17	1.17	1.56	1.56	260	260	260	260	260	1.56	1.56	1.56	1.56	1.56
19	257	259	258	259	259	259	0.78	0.39	0.78	0.78	0.78	259	259	260	260	260	0.78	0.78	1.17	1.17	1.17
20	255	256	256	256	257	257	0.39	0.39	0.39	0.78	0.78	257	257	258	258	258	0.78	0.78	1.18	1.18	1.18

Note:

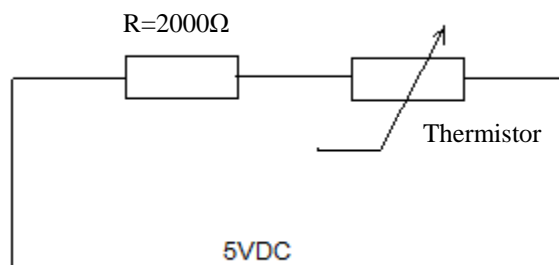





II. Low Temp. Action

<b>Purpose</b>	Test the durability of the thermistor in load voltage circuit and -30 °C																				
<b>Method</b>	Connect the circuit according to the figure below. The thermistor works in -30 °C for 192 hrs. During this process, measure the voltage of the two ends of thermistor every 24 hrs and then calculate the resistance value based on differential pressure principle. Compare the changing rate of this point before and after the test.																				
<b>Test data</b>																					
<b>No.</b>	<b>0h</b>	<b>24h</b>	<b>48h</b>	<b>72h</b>	<b>96h</b>	<b>120h</b>	<b>Change rate</b>					<b>144h</b>	<b>168h</b>	<b>192h</b>	<b>216h</b>	<b>240h</b>	<b>Change rate</b>				
<b>Temp. Field</b>	<b>V</b>	<b>V</b>	<b>V</b>	<b>V</b>	<b>V</b>	<b>V</b>	<b>δ1</b>	<b>δ2</b>	<b>δ3</b>	<b>δ4</b>	<b>δ5</b>	<b>V</b>	<b>V</b>	<b>V</b>			<b>δ1</b>	<b>δ2</b>	<b>δ3</b>	<b>δ4</b>	<b>δ5</b>
1	4.603	4.603	4.603	4.604	4.604	4.604	0.00	0.00	0.02	0.02	0.02	4.605	4.605	4.605			0.04	0.04	0.04		
2	4.600	4.599	4.600	4.600	4.600	4.600	-0.02	0.00	0.00	0.00	0.00	4.602	4.602	4.602			0.04	0.04	0.04		
3	4.589	4.589	4.590	4.590	4.590	4.590	0.00	0.02	0.02	0.02	0.02	4.591	4.591	4.592			0.04	0.04	0.07		
4	4.608	4.608	4.608	4.609	4.609	4.610	0.00	0.00	0.02	0.02	0.04	4.610	4.610	4.611			0.04	0.04	0.07		
5	4.616	4.617	4.617	4.618	4.618	4.619	0.02	0.02	0.04	0.04	0.06	4.619	4.620	4.620			0.06	0.09	0.09		
6	4.592	4.592	4.592	4.592	4.592	4.593	0.00	0.00	0.00	0.00	0.02	4.593	4.593	4.593			0.02	0.02	0.02		
7	4.601	4.601	4.601	4.602	4.602	4.602	0.00	0.00	0.02	0.02	0.02	4.603	4.603	4.603			0.04	0.04	0.04		
8	4.592	4.592	4.592	4.593	4.593	4.593	0.00	0.00	0.02	0.02	0.02	4.593	4.594	4.594			0.02	0.04	0.04		
9	4.608	4.609	4.609	4.609	4.609	4.610	0.02	0.02	0.02	0.02	0.04	4.610	4.611	4.611			0.04	0.07	0.07		
10	4.609	4.609	4.609	4.610	4.610	4.610	0.00	0.00	0.02	0.02	0.02	4.610	4.611	4.611			0.02	0.04	0.04		
11	4.608	4.608	4.608	4.609	4.609	4.609	0.00	0.00	0.02	0.02	0.02	4.609	4.610	4.609			0.02	0.04	0.02		
12	4.588	4.587	4.588	4.588	4.588	4.589	-0.02	0.00	0.00	0.00	0.02	4.589	4.589	4.589			0.02	0.02	0.02		
13	4.579	4.579	4.579	4.579	4.579	4.580	0.00	0.00	0.00	0.00	0.02	4.580	4.581	4.580			0.02	0.04	0.02		
14	4.601	4.601	4.601	4.601	4.601	4.602	0.00	0.00	0.00	0.00	0.02	4.602	4.602	4.602			0.02	0.02	0.02		



No.	0h	24h	48h	72h	96h	120h	Change rate					144h	168h	192h	216h	240h	Change rate				
	V	V	V	V	V	V	δ1	δ2	δ3	δ4	δ5	V	V	V			δ1	δ2	δ3	δ4	δ5
15	4.608	4.609	4.609	4.609	4.609	4.610	0.02	0.02	0.02	0.02	0.04	4.611	4.611	4.611			0.07	0.07	0.07		
16	4.611	4.610	4.611	4.611	4.611	4.612	-0.02	0.00	0.00	0.00	0.02	4.612	4.613	4.613			0.02	0.04	0.04		
17	4.595	4.595	4.596	4.596	4.596	4.596	0.00	0.02	0.02	0.02	0.02	4.596	4.596	4.597			0.02	0.02	0.04		
18	4.602	4.602	4.602	4.603	4.603	4.603	0.00	0.00	0.02	0.02	0.02	4.603	4.603	4.604			0.02	0.02	0.04		
19	4.606	4.606	4.606	4.607	4.607	4.607	0.00	0.00	0.02	0.02	0.02	4.607	4.607	4.607			0.02	0.02	0.02		
20	4.593	4.594	4.594	4.594	4.594	4.594	0.02	0.02	0.02	0.02	0.02	4.595	4.594	4.595			0.04	0.02	0.04		

Note:

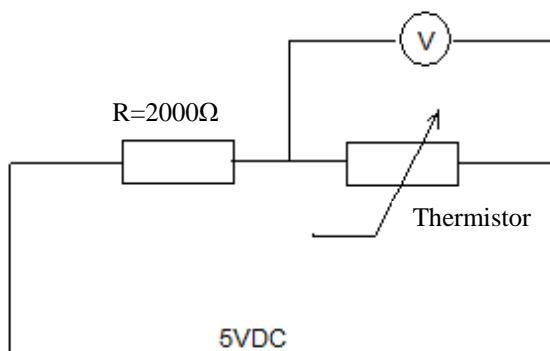



III. High Temp. Storage

<b>Purpose</b>		Test the high temperature resistance performance of the thermistor											
<b>Method</b>		Place the thermistor in a high temp. (+100 °C) for 1000 hrs; Measure the electrical property change before and after the test.											
<b>Test data</b>													
No.	0h	24h	336h	500h	800h	1000h	Change rate					B25/50	Change rate δ 6
							δ1	δ2	δ3	δ4	δ5		
<b>Temp. Field</b>													
1	9.867	9.869	9.888	9.897	9.9	9.909	0.02	0.21	0.30	0.33	0.43	3467	
2	9.875	9.879	9.898	9.907	9.915	9.916	0.04	0.23	0.32	0.41	0.42	3466	
3	9.877	9.879	9.882	9.888	9.902	9.903	0.02	0.05	0.11	0.25	0.26	3463	
4	9.869	9.872	9.884	9.891	9.9	9.906	0.03	0.15	0.22	0.31	0.37	3463	
5	9.809	9.811	9.82	9.823	9.844	9.849	0.02	0.11	0.14	0.36	0.41	3466	
6	9.887	9.889	9.898	9.919	9.923	9.928	0.02	0.11	0.32	0.36	0.41	3467	
7	9.861	9.862	9.883	9.891	9.892	9.903	0.01	0.22	0.30	0.31	0.43	3463	
8	9.827	9.829	9.838	9.862	9.872	9.869	0.02	0.11	0.36	0.46	0.43	3465	
9	9.792	9.793	9.803	9.822	9.824	9.838	0.01	0.11	0.31	0.33	0.47	3465	
10	9.777	9.781	9.790	9.797	9.803	9.806	0.04	0.13	0.20	0.27	0.30	3465	
11	9.802	9.804	9.813	9.83	9.835	9.841	0.02	0.11	0.29	0.34	0.40	3463	
12	9.8	9.802	9.816	9.816	9.818	9.822	0.02	0.16	0.16	0.18	0.23	3467	
13	9.849	9.853	9.86	9.867	9.874	9.88	0.04	0.11	0.18	0.25	0.31	3463	
14	9.851	9.853	9.866	9.881	9.896	9.897	0.02	0.15	0.30	0.46	0.47	3464	
15	9.844	9.846	9.855	9.875	9.885	9.886	0.02	0.11	0.31	0.42	0.43	3466	
16	9.849	9.849	9.86	9.879	9.879	9.886	0.00	0.11	0.30	0.30	0.38	3468	
17	9.867	9.868	9.876	9.889	9.896	9.909	0.01	0.09	0.22	0.29	0.43	3463	
18	9.873	9.874	9.886	9.892	9.903	9.915	0.01	0.13	0.19	0.30	0.43	3468	
19	9.87	9.872	9.876	9.887	9.895	9.899	0.02	0.06	0.17	0.25	0.29	3464	
20	9.875	9.879	9.886	9.912	9.922	9.924	0.04	0.11	0.37	0.48	0.50	3465	



IV. Low Temp. Storage

<b>Purpose</b>		Test the stability of the thermistor in low temperature											
<b>Method</b>		Put the thermistor in a low temperature environment (-40 °C) for 1000 hrs; Measure the electrical property change before and after the test.											
<b>Test data</b>													
No.	0h	24h	336h	500h	800h	1000h	Change rate					B25/50	Change rate
Temp. Field							$\delta 1$	$\delta 2$	$\delta 3$	$\delta 4$	$\delta 5$		$\delta 6$
1	9.896	9.895	9.895	9.896	9.897	9.897	-0.01	-0.01	0.00	0.01	0.01	3466	0.00
2	10.052	10.052	10.053	10.052	10.054	10.052	0.00	0.01	0.00	0.02	0.00	3463	0.00
3	9.829	9.829	9.829	9.829	9.829	9.829	0.00	0.00	0.00	0.00	0.00	3463	0.01
4	9.955	9.955	9.956	9.956	9.956	9.956	0.00	0.01	0.01	0.01	0.01	3465	0.00
5	10.032	10.033	10.032	10.035	10.035	10.035	0.01	0.00	0.03	0.03	0.03	3464	0.00
6	9.973	9.974	9.973	9.974	9.973	9.973	0.01	0.00	0.01	0.00	0.00	3464	0.00
7	9.832	9.833	9.834	9.833	9.8342	9.835	0.01	0.02	0.01	0.02	0.03	3465	0.01
8	9.911	9.912	9.911	9.912	9.912	9.912	0.01	0.00	0.01	0.01	0.01	3466	0.01
9	9.897	9.899	9.899	9.900	9.900	9.900	0.02	0.02	0.03	0.03	0.03	3465	0.01
10	9.886	9.887	9.886	9.886	9.887	9.887	0.01	0.00	0.00	0.01	0.01	3465	0.00
11	9.943	9.944	9.943	9.944	9.943	9.944	0.01	0.00	0.01	0.00	0.01	3466	0.00
12	9.812	9.813	9.813	9.812	9.813	9.812	0.01	0.01	0.00	0.01	0.00	3465	0.00
13	10.003	10.004	10.003	10.003	10.003	10.004	0.01	0.00	0.00	0.00	0.01	3464	0.00
14	9.882	9.883	9.883	9.883	9.882	9.882	0.01	0.01	0.01	0.00	0.00	3466	0.00
15	10.019	10.02	10.019	10.02	10.02	10.019	0.01	0.00	0.01	0.01	0.00	3465	0.01
16	9.935	9.936	9.937	9.938	9.938	9.939	0.01	0.02	0.03	0.03	0.04	3466	0.01
17	9.944	9.945	9.945	9.944	9.945	9.945	0.01	0.01	0.00	0.01	0.01	3465	0.01
18	9.879	9.88	9.881	9.88	9.881	9.881	0.01	0.02	0.01	0.02	0.02	3466	0.00
19	9.983	9.983	9.984	9.983	9.983	9.984	0.00	0.01	0.00	0.00	0.01	3466	0.00
20	9.909	9.91	9.909	9.91	9.911	9.91	0.01	0.00	0.01	0.02	0.01	3463	0.00



V. High Temp. & High Humidity

<b>Purpose</b>		Test the durability of the thermistor in a high temp. and high humidity condition											
<b>Method</b>		Put it in an environment of constant humidity RH=95% and temp. T=40 °C. Measure the electrical performance change after several hours.											
<b>Test data</b>													
No.	0h	24h	336h	500h	800h	1000h	Change rate					B25/50	Change rate
Temp. Field							δ1	δ2	δ3	δ4	δ5		δ 6
1	10.011	10.013	10.019	10.022	10.024	10.027	0.02	0.08	0.11	0.13	0.16	3462	0.01
2	10.003	10.003	10.01	10.015	10.015	10.018	0.00	0.07	0.12	0.12	0.15	3466	0.00
3	9.929	9.929	9.932	9.937	9.939	9.94	0.00	0.03	0.08	0.10	0.11	3463	0.01
4	9.961	9.965	9.966	9.969	9.97	9.971	0.04	0.05	0.08	0.09	0.10	3464	-0.01
5	10.091	10.091	10.093	10.096	10.096	10.097	0.00	0.02	0.05	0.05	0.06	3466	0.00
6	10.058	10.057	10.057	10.069	10.069	10.072	-0.01	-0.01	0.11	0.11	0.14	3466	0.00
7	9.932	9.933	9.936	9.94	9.944	9.944	0.01	0.04	0.08	0.12	0.12	3465	0.00
8	9.992	9.993	9.994	9.997	10.004	10.004	0.01	0.02	0.05	0.12	0.12	3463	0.01
9	9.967	9.967	9.972	9.973	9.973	9.976	0.00	0.05	0.06	0.06	0.09	3464	0.01
10	10.08	10.082	10.086	10.086	10.089	10.092	0.02	0.06	0.06	0.09	0.12	3463	0.02
11	9.933	9.933	9.937	9.939	9.948	9.95	0.00	0.04	0.06	0.15	0.17	3466	0.01
12	9.912	9.913	9.917	9.922	9.923	9.924	0.01	0.05	0.10	0.11	0.12	3463	0.00
13	9.943	9.944	9.948	9.948	9.952	9.952	0.01	0.05	0.05	0.09	0.09	3462	-0.01
14	9.965	9.964	9.968	9.968	9.973	9.973	-0.01	0.03	0.03	0.08	0.08	3466	0.00
15	10.049	10.049	10.055	10.056	10.056	10.055	0.00	0.06	0.07	0.07	0.06	3465	0.00
16	9.907	9.906	9.911	9.913	9.919	9.92	-0.01	0.04	0.06	0.12	0.13	3466	0.01
17	10.007	10.007	10.011	10.012	10.017	10.019	0.00	0.04	0.05	0.10	0.12	3463	0.01
18	10.052	10.05	10.056	10.057	10.058	10.061	-0.02	0.04	0.05	0.06	0.09	3464	-0.01
19	9.983	9.983	9.987	9.99	9.993	9.994	0.00	0.04	0.07	0.10	0.11	3464	0.00
20	10.077	10.077	10.082	10.083	10.083	10.084	0.00	0.05	0.06	0.06	0.07	3463	0.01



VI. Load Test

<b>Purpose</b>	Test the durability of the thermistor in load voltage circuit												
<b>Method</b>	Connect the circuit according to the figure below. Circulate 500 times in dry cold and hot environment. Circulating method: one cycle is to put it in a dry hot environment (+100 °C) for 30 min and remove it to room temperature for 30 min, and then dry low temp. (-30 °C) environment for 30 min, and then dry hot environment (+100 °C) for 30 min.												
<b>Test data</b>													
<b>No.</b>	<b>0</b>	<b>50 times</b>	<b>100 times</b>	<b>200 times</b>	<b>300 times</b>	<b>500 times</b>	<b>Change rate</b>					<b>B25/50</b>	<b>Change rate</b>
<b>Temp. Field</b>							<b>δ1</b>	<b>δ2</b>	<b>δ3</b>	<b>δ4</b>	<b>δ5</b>		<b>δ6</b>
1	9.882	9.886	9.891	9.906	9.918	9.923	0.04	0.09	0.24	0.36	0.41	3463	
2	9.977	9.978	9.983	10.002	10.01	10.017	0.01	0.06	0.25	0.33	0.40	3466	
3	9.701	9.704	9.708	9.73	9.735	9.739	0.03	0.07	0.30	0.35	0.39	3466	
4	9.725	9.731	9.736	9.747	9.761	9.761	0.06	0.11	0.23	0.37	0.37	3464	
5	9.867	9.869	9.876	9.886	9.901	9.906	0.02	0.09	0.19	0.34	0.40	3466	
6	9.784	9.786	9.788	9.808	9.828	9.831	0.02	0.04	0.25	0.45	0.48	3463	
7	9.746	9.750	9.753	9.766	9.772	9.778	0.04	0.07	0.21	0.27	0.33	3465	
8	9.825	9.826	9.829	9.846	9.848	9.853	0.01	0.04	0.21	0.23	0.28	3464	
9	9.725	9.726	9.729	9.749	9.762	9.767	0.01	0.04	0.25	0.38	0.43	3464	
10	9.777	9.777	9.783	9.801	9.821	9.824	0.00	0.06	0.25	0.45	0.48	3464	
11	9.742	9.747	9.753	9.775	9.779	9.784	0.05	0.11	0.34	0.38	0.43	3465	
12	9.89	9.894	9.894	9.908	9.916	9.921	0.04	0.04	0.18	0.26	0.31	3466	
13	9.843	9.846	9.849	9.868	9.873	9.878	0.03	0.06	0.25	0.30	0.36	3466	
14	9.769	9.770	9.773	9.789	9.792	9.798	0.01	0.04	0.20	0.24	0.30	3463	
15	9.775	9.779	9.784	9.789	9.792	9.797	0.04	0.09	0.14	0.18	0.23	3463	
16	9.829	9.830	9.833	9.838	9.862	9.864	0.01	0.04	0.09	0.34	0.35	3464	
17	9.823	9.825	9.829	9.847	9.842	9.847	0.02	0.06	0.24	0.19	0.24	3465	
18	9.767	9.769	9.774	9.796	9.796	9.798	0.02	0.07	0.30	0.30	0.32	3464	
19	9.809	9.813	9.819	9.829	9.829	9.831	0.04	0.10	0.20	0.20	0.22	3465	
20	9.811	9.812	9.815	9.828	9.844	9.849	0.01	0.04	0.17	0.34	0.39	3466	



Note:

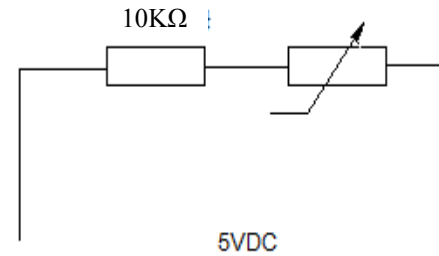
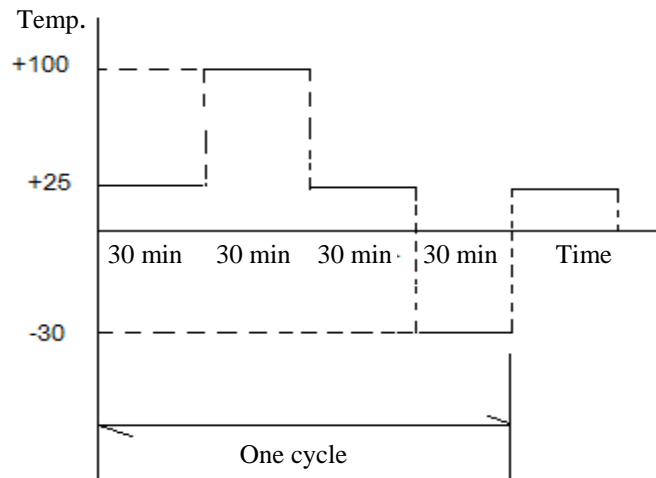



VII. Cold and Hot Impact

<b>Purpose</b>	Test the cold and hot impact performance of the thermistor												
<b>Method</b>	Connect the circuit according to the figure below, and electrical property change rate. Circulate 500 times in dry cold and hot environment. Circulating method: one cycle is to put it in dry hot environment (+100 °C) for 10 min and take out to put in room temperature for 5 min, and then dry low temp. (-30 °C) environment for 10 min, and then dry hot environment (+100 °C) for 10 min.												
<b>Test data</b>													
No.	0h	24h	336h	500h	800h	1000h	Change rate					B25/50	Change rate
Temp. Field							δ1	δ2	δ3	δ4	δ5		δ 6
1	10.118	10.129	10.173	10.177	10.18	10.184	0.11	0.54	0.58	0.61	0.65	3463	
2	10.182	10.193	10.221	10.225	10.229	10.23	0.11	0.38	0.42	0.46	0.47	3466	
3	10.157	10.1886	10.2176	10.2216	10.2256	10.2266	0.31	0.60	0.64	0.68	0.69	3466	
4	10.2	10.2016	10.2256	10.2306	10.2336	10.2376	0.02	0.25	0.30	0.33	0.37	3464	
5	10.166	10.1766	10.2106	10.2116	10.2126	10.2146	0.10	0.44	0.45	0.46	0.48	3466	
6	10.192	10.206	10.2294	10.2334	10.2364	10.2404	0.14	0.37	0.41	0.44	0.47	3463	
7	10.112	10.123	10.167	10.171	10.172	10.175	0.11	0.54	0.58	0.59	0.62	3465	
8	10.154	10.166	10.1834	10.1854	10.1854	10.1894	0.12	0.29	0.31	0.31	0.35	3464	
9	10.143	10.143	10.177	10.181	10.184	10.19	0.00	0.34	0.37	0.40	0.46	3464	
10	10.218	10.2276	10.2516				0.09						
11	10.221	10.2256	10.2596	10.2636	10.2666	10.2706	0.05	0.38	0.42	0.45	0.49	3465	
12	10.173	10.189	10.233	10.237	10.238	10.241	0.16	0.59	0.63	0.64	0.67	3466	
13	10.167	10.178	10.222	10.223	10.224	10.228	0.11	0.54	0.55	0.56	0.60	3466	
14	10.175	10.193	10.224	10.228	10.231	10.231	0.18	0.48	0.52	0.55	0.55	3463	
15	10.177	10.197	10.241	10.241	10.242	10.243	0.20	0.63	0.63	0.64	0.65	3463	
16	10.128	10.138	10.152	10.156	10.159	10.163	0.10	0.24	0.28	0.31	0.35	3464	
17	10.11	10.116	10.129	10.134	10.137	10.139	0.06	0.19	0.24	0.27	0.29	3465	
18	10.221	10.2346	10.2786	10.2826	10.2826	10.2836	0.13	0.56	0.60	0.60	0.61	3464	
19	10.192	10.1936	10.2476	10.2496	10.2526	10.2566	0.02	0.55	0.57	0.59	0.63	3465	
20	10.137	10.1556	10.1896	10.1936	10.1956	10.1986	0.18	0.52	0.56	0.58	0.61	3466	





Note:

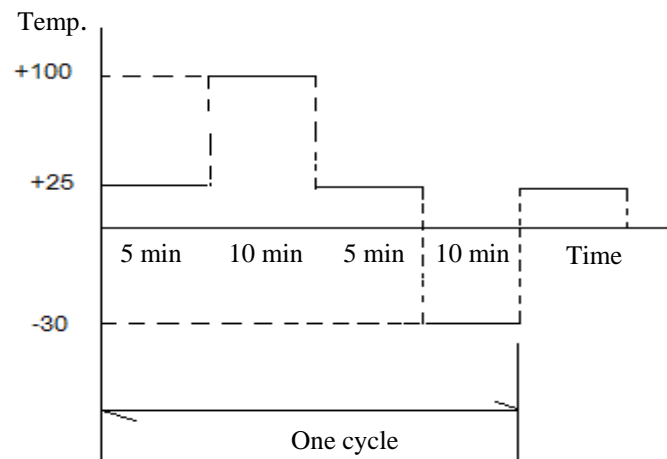



VIII. Durability Test

<b>Purpose</b>		Test the durability of the thermistor with load											
<b>Method</b>		Connect the circuit according to the figure below, in an environment of humidity RH=95% and temp. T=40 °C. Measure the electrical performance change after 10000 hrs.											
<b>Test data</b>													
No.	0h	500h	2000h	5000h	8000h	10000h	Change rate					B25/50	Change rate
Temp. Field							δ1	δ2	δ3	δ4	δ5		δ 6
1	9.934	9.937	9.979	10.028	10.058	10.06	0.03	0.45	0.95	1.25	1.27	3460	
2	9.925	9.927	9.98	10.015	10.025	10.027	0.02	0.55	0.91	1.01	1.03	3462	
3	9.989	9.995	10.034	10.099	10.121	10.121	0.06	0.45	1.10	1.32	1.32	3463	
4	9.896	9.899	9.931	10.036	10.058	10.059	0.03	0.35	1.41	1.64	1.65	3461	
5	9.901	9.906	9.946	10.011	10.041	10.043	0.05	0.45	1.11	1.41	1.43	3460	
6	9.944	9.954	9.969	10.044	10.074	10.078	0.10	0.25	1.01	1.31	1.35	3461	
7	9.967	9.974	10.012	10.047	10.066	10.068	0.07	0.45	0.80	0.99	1.01	3461	
8	9.878	9.881	9.943	9.97	10	10.002	0.03	0.66	0.93	1.24	1.26	3466	
9	9.911	9.913	9.964	10.012	10.032	10.035	0.02	0.53	1.02	1.22	1.25	3461	
10	9.971	9.981	10.016	10.068	10.098	10.099	0.10	0.45	0.97	1.27	1.28	3463	
11	9.991	9.999	10.063	10.101	10.131	10.133	0.08	0.72	1.10	1.40	1.42	3460	
12	9.949	9.952	9.994	10.05	10.074	10.076	0.03	0.45	1.02	1.26	1.28	3461	
13	9.917	9.928	9.982	10.004	10.034	10.036	0.11	0.66	0.88	1.18	1.20	3460	
14	9.926	9.929	9.971	10.009	10.019	10.021	0.03	0.45	0.84	0.94	0.96	3461	
15	9.951	9.952	9.996	10.042	10.069	10.074	0.01	0.45	0.91	1.19	1.24	3461	
16	9.945	9.948	9.981	10.043	10.073	10.075	0.03	0.36	0.99	1.29	1.31	3461	
17	9.962	9.974	10.007	10.072	10.092	10.096	0.12	0.45	1.10	1.30	1.35	3460	
18	9.987	9.990	10.032	10.072	10.102	10.104	0.03	0.45	0.85	1.15	1.17	3462	
19	9.879	9.887	9.914	9.979	10	10.004	0.08	0.35	1.01	1.22	1.27	3464	
20	9.928	9.933	9.953	10.019	10.036	10.038	0.05	0.25	0.92	1.09	1.11	3461	



Note:

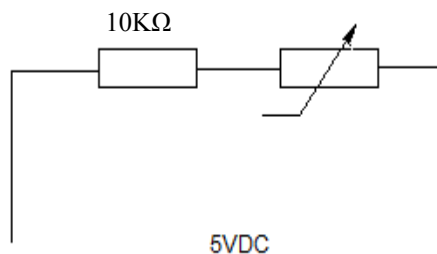



IX. Vibration Test

<b>Purpose</b>	Test the electrical performance stability of the thermistor in vibration temperature												
<b>Method</b>	Vibrating method: 1. Frequency: 50~550HZ; 2. Accelerated speed: 38g; 3. Vibration direction: X-Y-Z axis; 4. Vibration time: 25 hrs for each axis												
<b>Test data</b>													
<b>No.</b>	<b>0h</b>	<b>24h</b>	<b>336h</b>	<b>500h</b>	<b>800h</b>	<b>1000h</b>	<b>Change rate</b>					<b>B25/50</b>	<b>Change rate</b>
<b>Temp. Field</b>							<b>δ1</b>	<b>δ2</b>	<b>δ3</b>	<b>δ4</b>	<b>δ5</b>		<b>δ6</b>
1	10.223	10.244					0.21						
2	10.241	10.251					0.10						
3	10.332	10.337					0.05						
4	10.254	10.278					0.23						
5	10.273	10.292					0.18						
6	10.262	10.275					0.13						
7	10.2	10.203					0.03						
8	10.291	10.298					0.07						
9	10.235	10.255					0.20						
10	10.311	10.323					0.12						
11	10.279	10.29					0.11						
12	10.255	10.283					0.27						
13	10.304	10.322					0.17						
14	10.216	10.225					0.09						
15	10.298	10.324					0.25						
16	10.338	10.341					0.03						
17	10.229	10.24					0.11						
18	10.251	10.264					0.13						
19	10.283	10.306					0.22						
20	10.357	10.365					0.08						



**NOTICE**

1. ATI reserves the right to make changes to its products or to discontinue any product or service without notice, and advise customers to obtain the latest version of relevant information to verify, before placing orders, that information being relied on is current and complete.
2. All products are sold subject to the terms and conditions of sale supplied at the time of order acknowledgment, including those pertaining to warranty, patent infringement, and limitation of liability. Testing and other quality control techniques are utilized to the extent ATI deems necessary to support this warranty. Specific testing of all parameters of each device is not necessarily performed, except those mandated by government requirements.
3. Customers are responsible for their applications using ATI components. In order to minimize risks associated with the customers' applications, adequate design and operating safeguards must be provided by the customers to minimize inherent or procedural hazards. ATI assumes no liability for applications assistance or customer product design.
4. ATI does not warrant or represent that any license, either expressed or implied, is granted under any patent right, copyright, mask work right, or other intellectual property rights of ATI covering or relating to any combination, machine, or process in which such products or services might be or are used. ATI's publication of information regarding any third party's products or services does not constitute ATI's approval, warranty or endorsement thereof.
5. IP (Intellectual Property) Ownership: ATI retains the ownership of full rights for special technologies and/or techniques embedded in its products, the designs for mechanics, optics, plus all modifications, improvements, and inventions made by ATI for its products and/or projects.