

**FEATURES****Low noise figure: 1.1 dB typical****High gain: 19.5 dB typical****High output third order intercept (IP3): 33 dBm typical****Die size: 0.95 mm × 0.61 × 0.102 mm****APPLICATIONS****Software defined radios****Electronic warfare****Radar applications****GENERAL DESCRIPTION**

The [HMC8410CHIPS](#) is a gallium arsenide (GaAs), monolithic microwave integrated circuit (MMIC), pseudomorphic high electron mobility transistor (pHEMT), low noise wideband amplifier that operates from 0.01 GHz to 10 GHz. The [HMC8410CHIPS](#) provides a typical gain of 19.5 dB, a 1.1 dB typical noise figure, and a typical output IP3 of 33 dBm, requiring only 65 mA from a 5 V supply voltage. The saturated output power ( $P_{SAT}$ ) of

**FUNCTIONAL BLOCK DIAGRAM**

Figure 1.

22.5 dBm enables the low noise amplifier (LNA) to function as a local oscillator (LO) driver for many of Analog Devices, Inc., balanced, I/Q or image rejection mixers.

The [HMC8410CHIPS](#) also features inputs/outputs that are internally matched to 50  $\Omega$ , making it ideal for surface mounted technology (SMT)-based, high capacity microwave radio applications.

**TABLE OF CONTENTS**

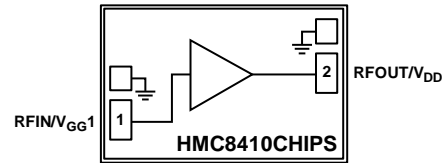
Features .....	1	Pin Configuration and Function Descriptions.....	6
Applications.....	1	Interface Schematics .....	6
Functional Block Diagram .....	1	Typical Performance Characteristics .....	7
General Description .....	1	Theory of Operation .....	13
Revision History .....	2	Applications Information .....	14
Specifications.....	3	Recommended Bias Sequencing .....	14
0.01 GHz to 3 GHz Frequency Range.....	3	Mounting and Bonding Techniques for Millimeterwave GaAs MMICs.....	14
3 GHz to 8 GHz Frequency Range.....	3	Application Circuit.....	16
8 GHz to 10 GHz Frequency Range.....	4	Assembly Diagram .....	16
Absolute Maximum Ratings.....	5	Outline Dimensions .....	17
Thermal Resistance .....	5	Ordering Guide .....	17
ESD Caution.....	5		

**REVISION HISTORY**

**11/2018—Rev. A to Rev. B**

Updated Outline Dimensions .....	17
----------------------------------	----

**1/2018—Rev. 0 to Rev. A**

Added Output Second Order Intercept Parameter, Table 1 and Output Second Order Intercept Parameter, Table 2.....	3
Change to Noise Figure Parameter Test Conditions, Table 1 .....	3
Added Output Second Order Parameter, Table 3.....	4
Changes to Table 6.....	6
Change to Figure 33 .....	11
Moved Figure 35 .....	12
Added Figure 36; Renumbered Sequentially .....	12

**10/2016—Revision 0: Initial Version**

## SPECIFICATIONS

### 0.01 GHz TO 3 GHz FREQUENCY RANGE

$T_A = 25^\circ\text{C}$ ,  $V_{DD} = 5\text{ V}$ , and  $I_{DQ} = 65\text{ mA}$ , unless otherwise noted.

Table 1.

Parameter	Symbol	Min	Typ	Max	Unit	Test Conditions/Comments
FREQUENCY RANGE		0.01		3	GHz	
GAIN		17.5	19.5		dB	
Gain Variation Over Temperature			0.01		dB/°C	
NOISE FIGURE			1.1	1.6	dB	0.3 GHz to 3 GHz
RETURN LOSS						
Input			15		dB	
Output			24		dB	
OUTPUT						
Output Power for 1 dB Compression	P1dB	19.0	21.0		dBm	
Saturated Output Power	P <sub>SAT</sub>		22.5		dBm	
Output Third Order Intercept	IP3		33		dBm	
Output Second Order Intercept	IP2		37		dBm	
SUPPLY						
Current	I <sub>DQ</sub>		65	80	mA	Adjust V <sub>GG1</sub> to achieve I <sub>DQ</sub> = 65 mA typical
Voltage	V <sub>DD</sub>	2	5	6	V	

### 3 GHz TO 8 GHz FREQUENCY RANGE

$T_A = 25^\circ\text{C}$ ,  $V_{DD} = 5\text{ V}$ , and  $I_{DQ} = 65\text{ mA}$ , unless otherwise noted.

Table 2.

Parameter	Symbol	Min	Typ	Max	Unit	Test Conditions/Comments
FREQUENCY RANGE		3		8	GHz	
GAIN		15.5	18		dB	
Gain Variation Over Temperature			0.01		dB/°C	
NOISE FIGURE			1.4	1.9	dB	
RETURN LOSS						
Input			12		dB	
Output			12		dB	
OUTPUT						
Output Power for 1 dB Compression	P1dB	17.5	20.5		dBm	
Saturated Output Power	P <sub>SAT</sub>		22.5		dBm	
Output Third Order Intercept	IP3		31.5		dBm	
Output Second Order Intercept	IP2		33		dBm	
SUPPLY						
Current	I <sub>DQ</sub>		65	80	mA	Adjust V <sub>GG1</sub> to achieve I <sub>DQ</sub> = 65 mA typical
Voltage	V <sub>DD</sub>	2	5	6	V	

## 8 GHz TO 10 GHz FREQUENCY RANGE

$T_A = 25^\circ\text{C}$ ,  $V_{DD} = 5\text{ V}$ , and  $I_{DQ} = 65\text{ mA}$ , unless otherwise noted.

Table 3.

Parameter	Symbol	Min	Typ	Max	Unit	Test Conditions/Comments
FREQUENCY RANGE		8		10	GHz	
GAIN		13	16		dB	
Gain Variation Over Temperature			0.01		dB/°C	
NOISE FIGURE			1.7	2.2	dB	
RETURN LOSS						
Input			6		dB	
Output			10		dB	
OUTPUT						
Output Power for 1 dB Compression	P1dB	17.5	19.5		dBm	
Saturated Output Power	$P_{SAT}$		21.5		dBm	
Output Third Order Intercept	IP3		33		dBm	
Output Second Order Intercept	IP2		33		dBm	
SUPPLY						
Current	$I_{DQ}$		65	80	mA	Adjust $V_{GG1}$ to achieve $I_{DQ} = 65\text{ mA}$ typical
Voltage	$V_{DD}$	2	5	6	V	

## ABSOLUTE MAXIMUM RATINGS

Table 4.

Parameter <sup>1</sup>	Rating
Drain Bias Voltage ( $V_{DD}$ )	7 V dc
Radio Frequency (RF) Input Power (RFIN)	20 dBm
Continuous Power Dissipation ( $P_{DISS}$ ), $T = 85^{\circ}\text{C}$ (Derate 13.23 mW/ $^{\circ}\text{C}$ Above $85^{\circ}\text{C}$ )	1.2 W
Channel Temperature	175 $^{\circ}\text{C}$
Storage Temperature Range	-65 $^{\circ}\text{C}$ to +150 $^{\circ}\text{C}$
Operating Temperature Range	-55 $^{\circ}\text{C}$ to +85 $^{\circ}\text{C}$
ESD Sensitivity	
Human Body Model (HBM)	Class 1B passed 500 V

<sup>1</sup> When referring to a single function of a multifunction pin in the parameters, only the portion of the pin name that is relevant to the specification is listed. For the full pin names of multifunction pins, refer to the Pin Configuration and Function Descriptions section.

<sup>2</sup> See the Ordering Guide section for more information.

Stresses at or above those listed under Absolute Maximum Ratings may cause permanent damage to the product. This is a stress rating only; functional operation of the product at these or any other conditions above those indicated in the operational section of this specification is not implied. Operation beyond the maximum operating conditions for extended periods may affect product reliability.

## THERMAL RESISTANCE

$\theta_{JC}$  is the junction to case thermal resistance, and channel to bottom of die.

Table 5. Thermal Resistance

Package Type	$\theta_{JC}$	Unit
C-2-3	75.57	$^{\circ}\text{C}/\text{W}$

## ESD CAUTION



**ESD (electrostatic discharge) sensitive device.** Charged devices and circuit boards can discharge without detection. Although this product features patented or proprietary protection circuitry, damage may occur on devices subjected to high energy ESD. Therefore, proper ESD precautions should be taken to avoid performance degradation or loss of functionality.

## PIN CONFIGURATION AND FUNCTION DESCRIPTIONS

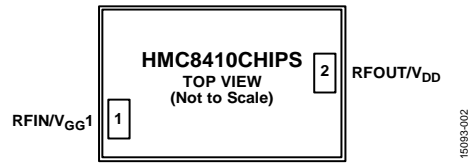

Figure 2. Pad Configuration

Table 6. Pad Function Descriptions

Pin No.	Mnemonic	Description
1	RFIN/V <sub>GG1</sub>	RF Input (RFIN). This pin is dc-coupled and matched to 50 Ω. See Figure 4 for the interface schematic. Gate Bias of the Amplifier (V <sub>GG1</sub> ). This pin is dc-coupled and matched to 50 Ω. See Figure 4 for the interface schematic.
2	RFOUT/V <sub>DD</sub>	RF Output (RFOUT). This pin is dc-coupled and matched to 50 Ω. See Figure 5 for the interface schematic. Drain Bias for Amplifier (V <sub>DD</sub> ). This pin is dc-coupled and matched to 50 Ω. See Figure 5 for the interface schematic.
Die Bottom	GND	Ground. Die Bottom. This pin must be connected to RF/dc ground.

### INTERFACE SCHEMATICS



Figure 3. GND Interface Schematic

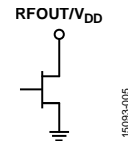

Figure 5. RFOUT/V<sub>DD</sub> Interface Schematic

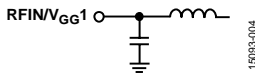

Figure 4. RFIN/V<sub>GG1</sub> Interface Schematic

### TYPICAL PERFORMANCE CHARACTERISTICS

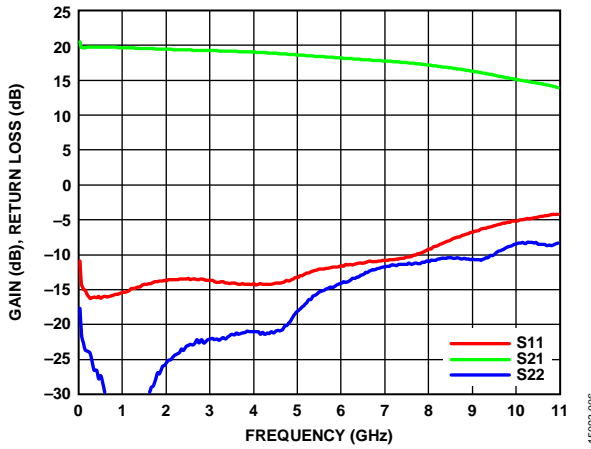

Figure 6. Gain and Return Loss vs. Frequency

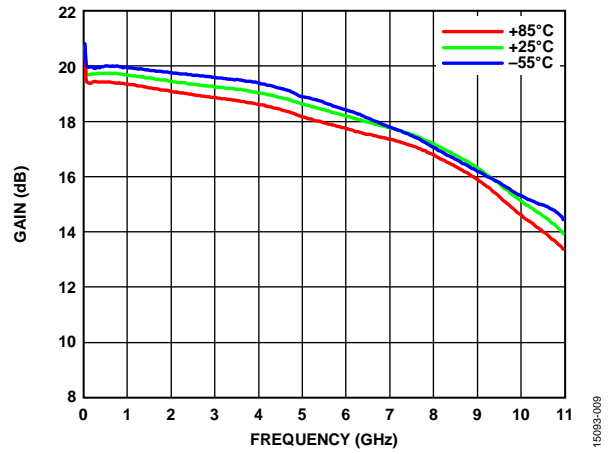

Figure 9. Gain vs. Frequency for Various Temperatures

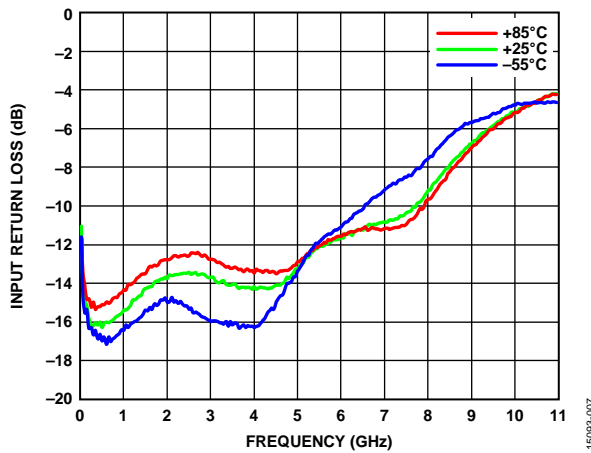

Figure 7. Input Return Loss vs. Frequency for Various Temperatures

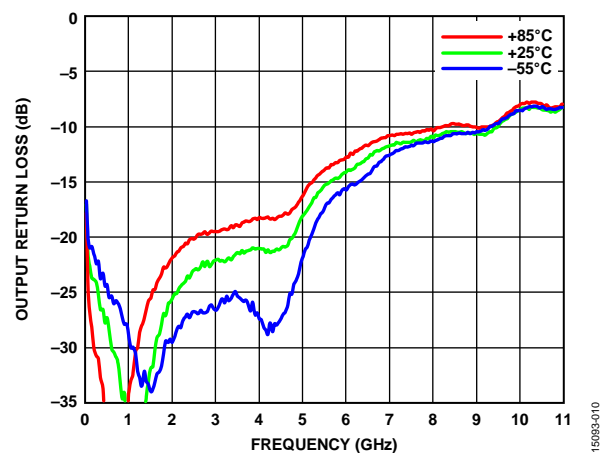

Figure 10. Output Return Loss vs. Frequency for Various Temperatures

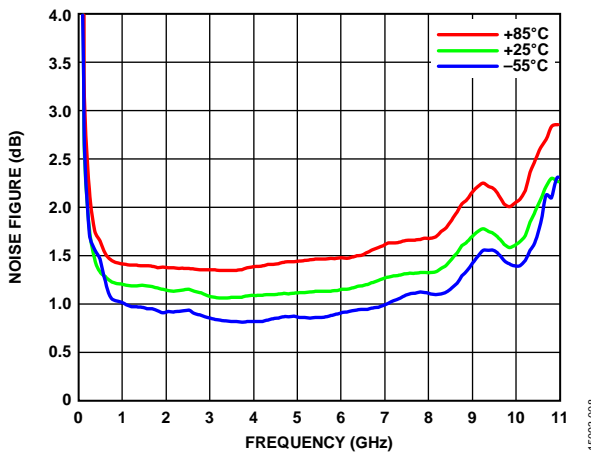

Figure 8. Noise Figure vs. Frequency for Various Temperatures

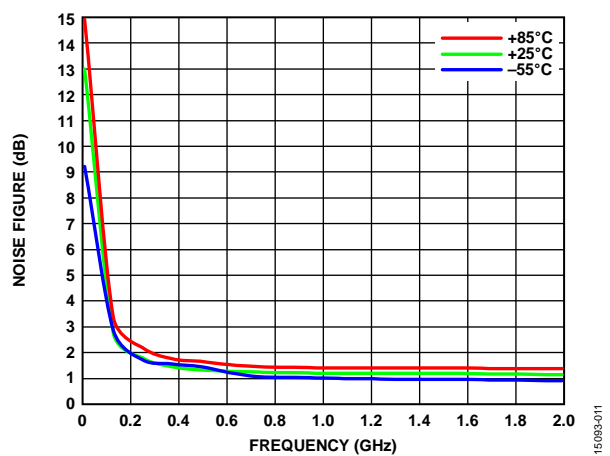

Figure 11. Noise Figure vs. Frequency for Various Temperatures, 10 MHz to 1 GHz

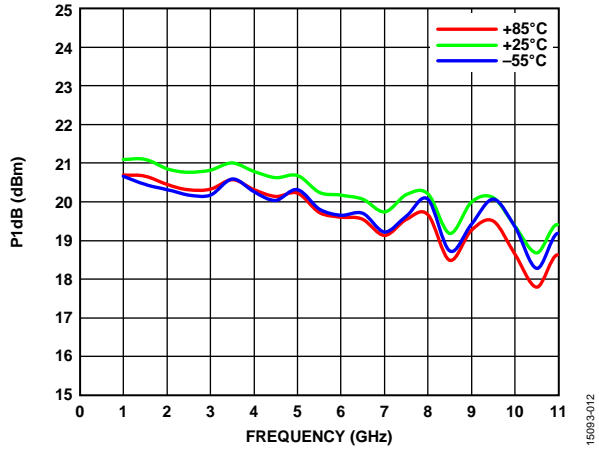

Figure 12. P1dB vs. Frequency for Various Temperatures

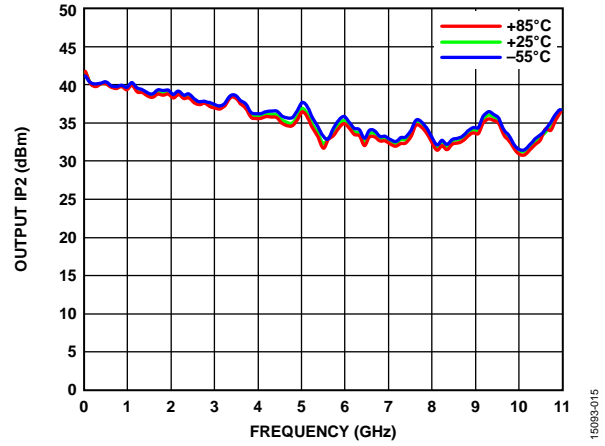

Figure 15. Output IP2 vs. Frequency for Various Temperatures at  $P_{OUT}/Tone = 5 \text{ dBm}$

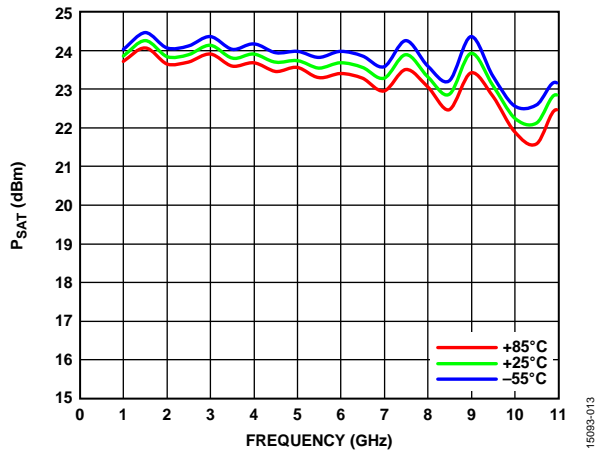

Figure 13.  $P_{SAT}$  vs. Frequency for Various Temperatures

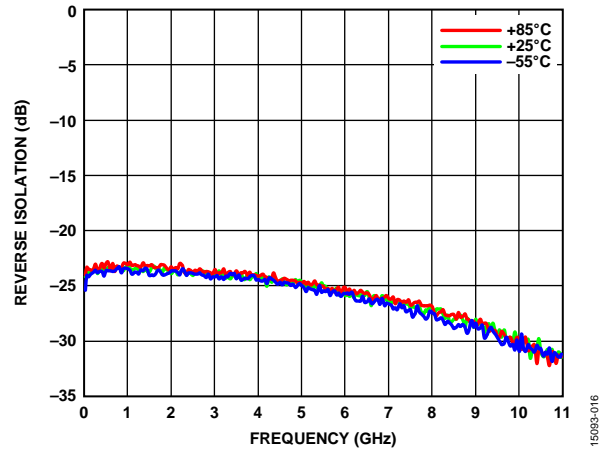

Figure 16. Reverse Isolation vs. Frequency for Various Temperatures

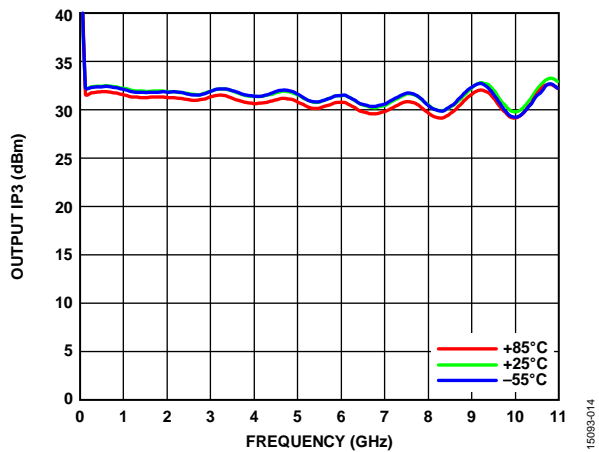

Figure 14. Output IP3 vs. Frequency for Various Temperatures, Output Power ( $P_{OUT}$ )/Tone = 5 dBm

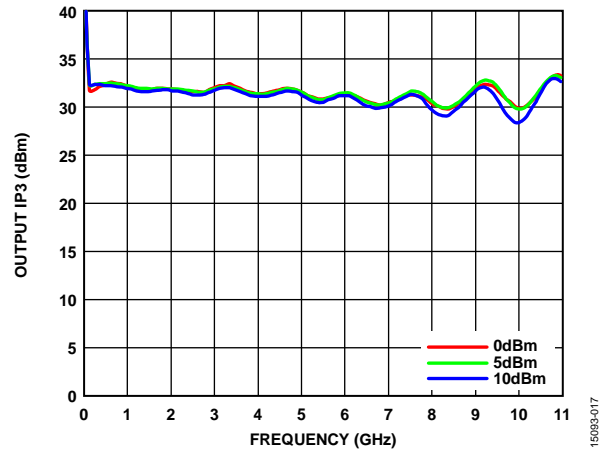

Figure 17. Output IP3 vs. Frequency for Various  $P_{OUT}/Tone$



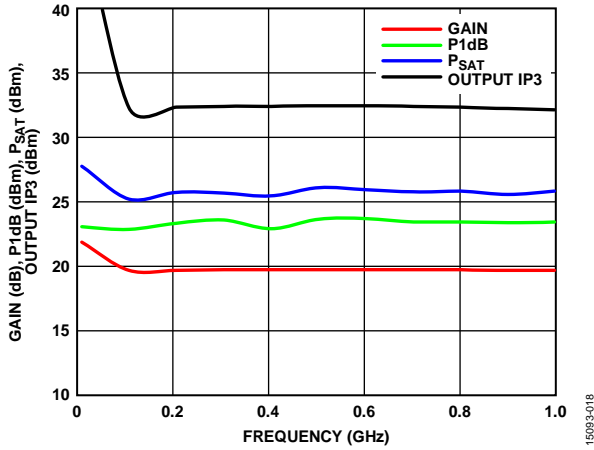

Figure 18. Gain, P1dB,  $P_{SAT}$ , and Output IP3 vs. Frequency

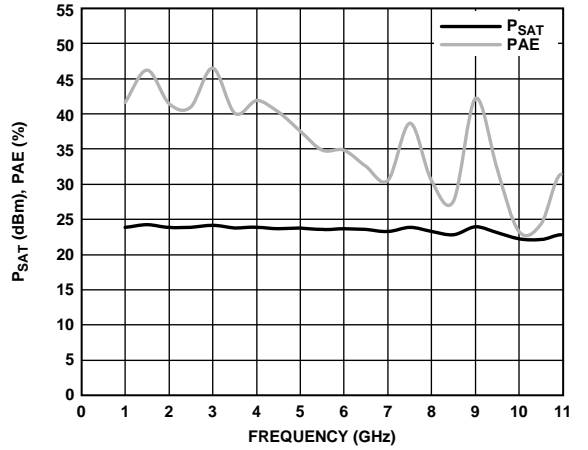

Figure 21.  $P_{SAT}$  and PAE vs. Frequency

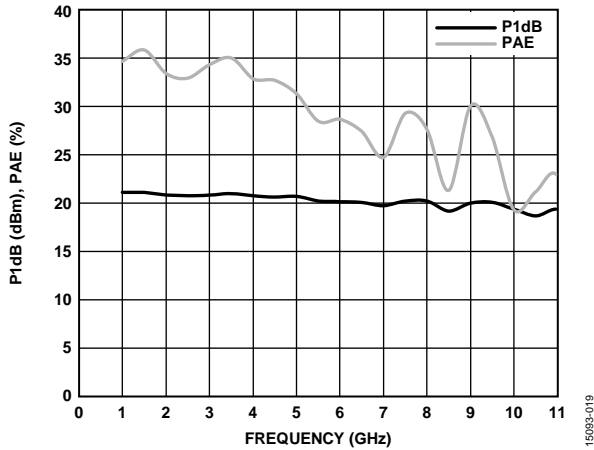

Figure 19. P1dB and Power Added Efficiency (PAE) vs. Frequency

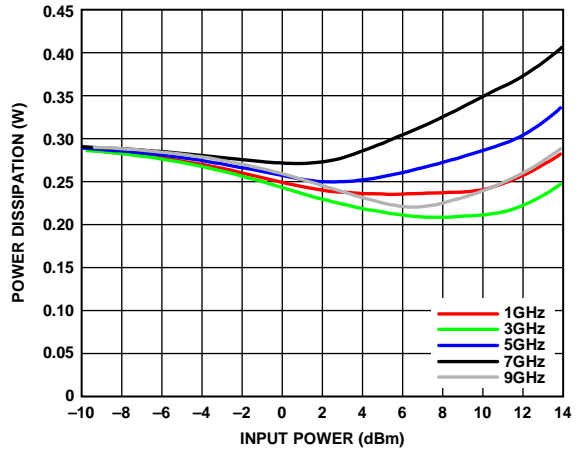

Figure 22. Power Dissipation vs. Input Power for Various Frequencies,  $T_A = 85^\circ\text{C}$

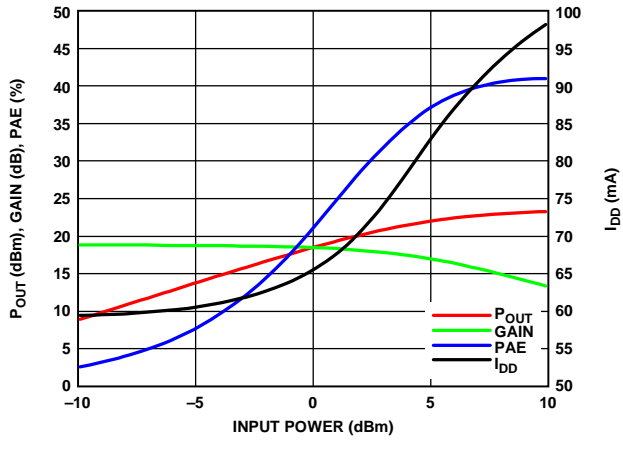

Figure 20.  $P_{OUT}$ , Gain, PAE, and Supply Current ( $I_{DD}$ ) with RF Applied ( $I_{DD}$ ) vs. Input Power at 5 GHz

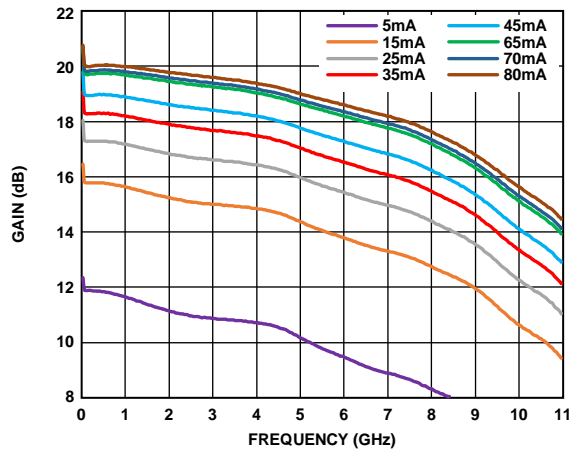

Figure 23. Gain vs. Frequency for Various Supply Currents ( $I_{DD}$ ),  $V_{DD} = 5\text{ V}$

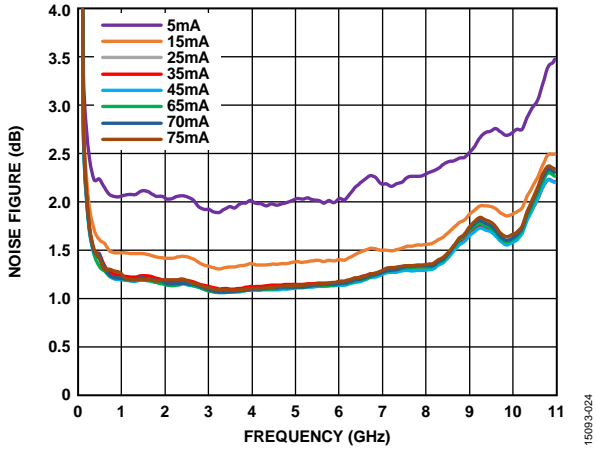

Figure 24. Noise Figure vs. Frequency for Various Supply Currents ( $I_{DQ}$ ),  $V_{DD} = 5\text{ V}$

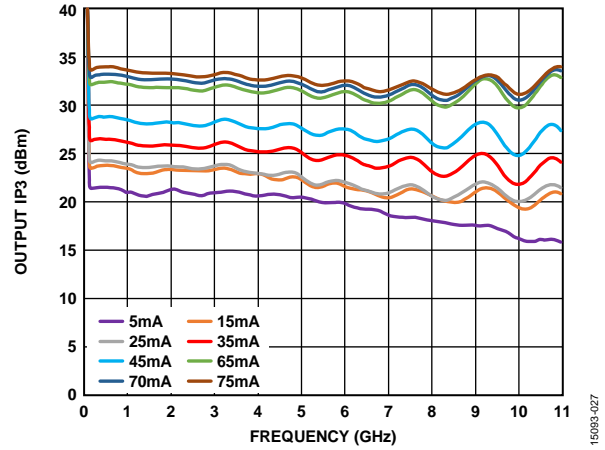

Figure 27. Output IP3 vs. Frequency for Various Supply Currents ( $I_{DQ}$ ),  $P_{OUT}/\text{Tone} = 5\text{ dBm}$ ,  $V_{DD} = 5\text{ V}$

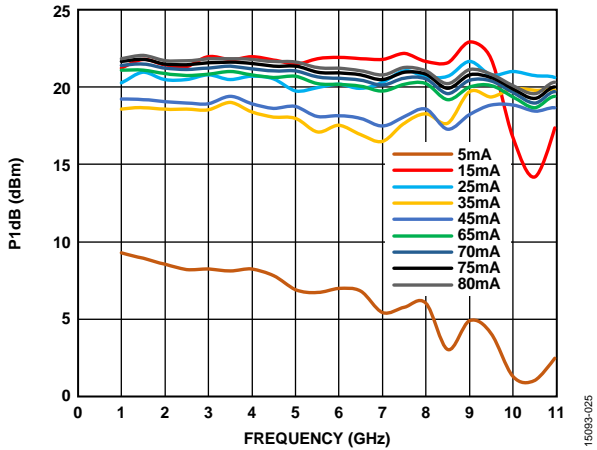

Figure 25. P1dB vs. Frequency for Various Supply Currents ( $I_{DQ}$ ),  $V_{DD} = 5\text{ V}$

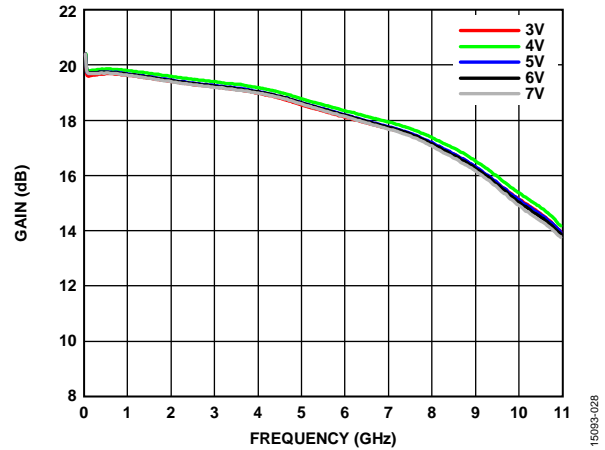

Figure 28. Gain vs. Frequency for Various Supply Voltages,  $I_{DQ} = 65\text{ mA}$

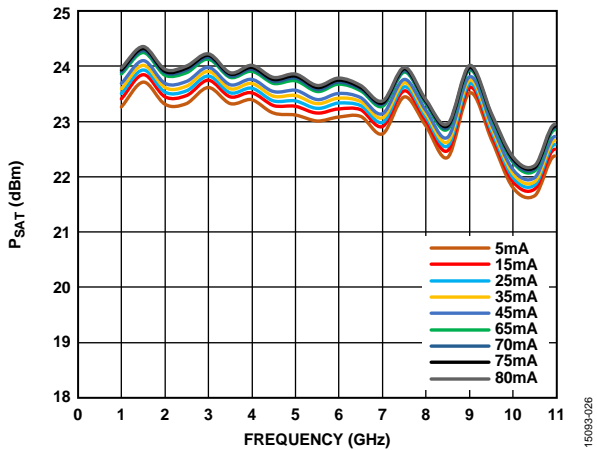

Figure 26.  $P_{SAT}$  vs. Frequency for Various Supply Currents ( $I_{DQ}$ ),  $V_{DD} = 5\text{ V}$

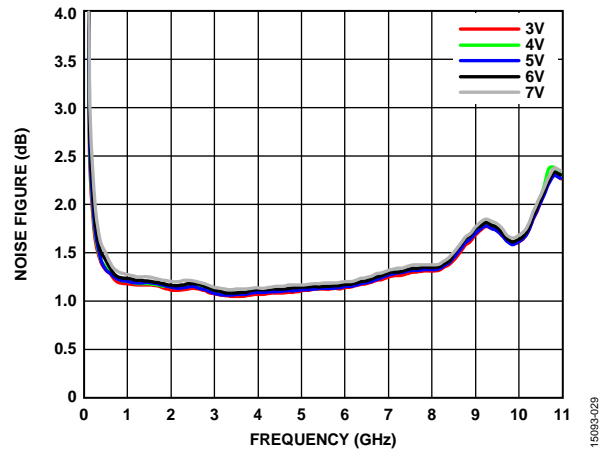

Figure 29. Noise Figure vs. Frequency for Various Supply Voltages,  $I_{DQ} = 65\text{ mA}$

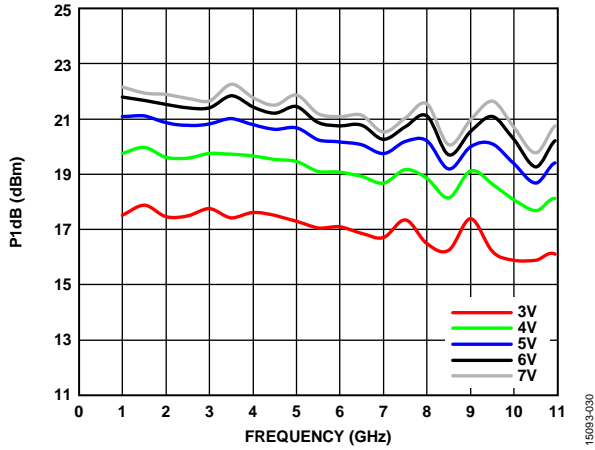

Figure 30. P1dB vs. Frequency for Various Supply Voltages,  $I_{DQ} = 65$  mA

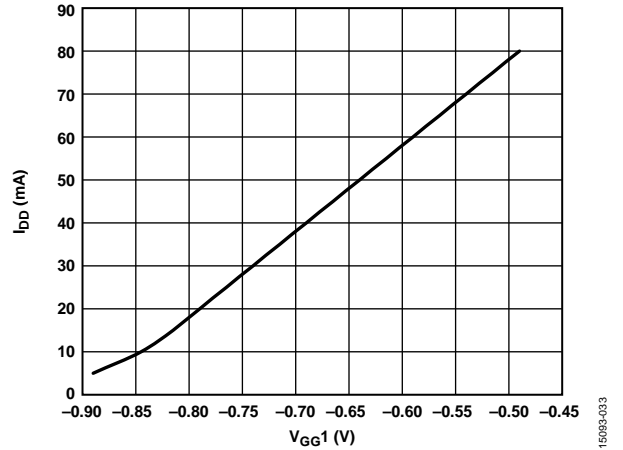

Figure 33. Supply Current ( $I_{DD}$ ) vs.  $V_{GG1}$ ,  $V_{DD} = 5$  V, Representative of a Typical Device

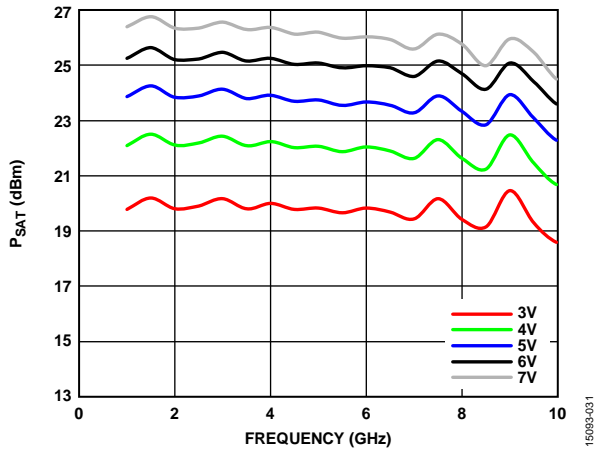

Figure 31.  $P_{SAT}$  vs. Frequency for Various Supply Voltages,  $I_{DQ} = 65$  mA

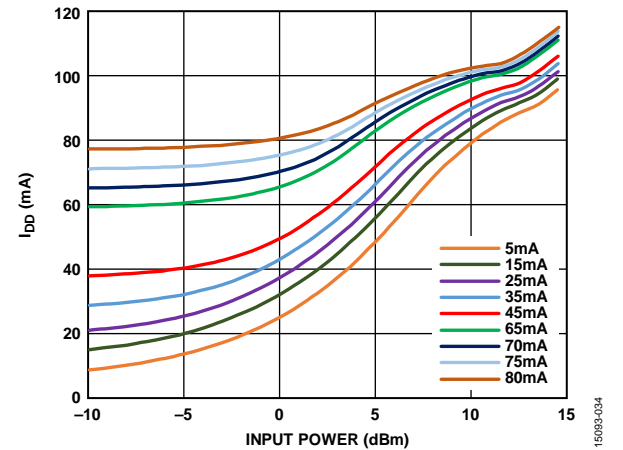

Figure 34. Supply Current with RF Applied ( $I_{DD}$ ) vs. Input Power for Various Supply Currents ( $I_{DQ}$ ),  $V_{DD} = 5$  V

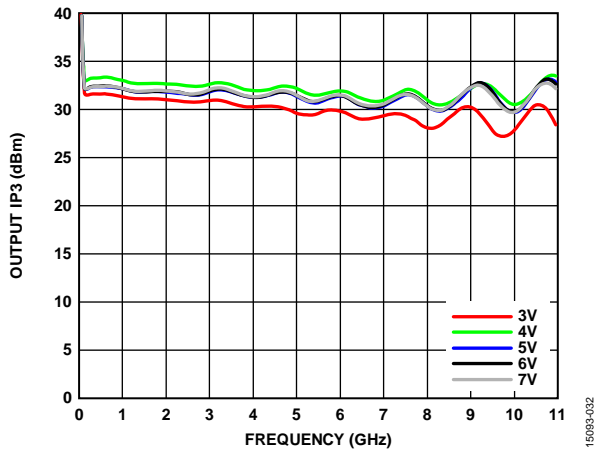

Figure 32. Output IP3 vs. Frequency for Various Supply Voltages,  $P_{OUT}/Tone = 5$  dBm

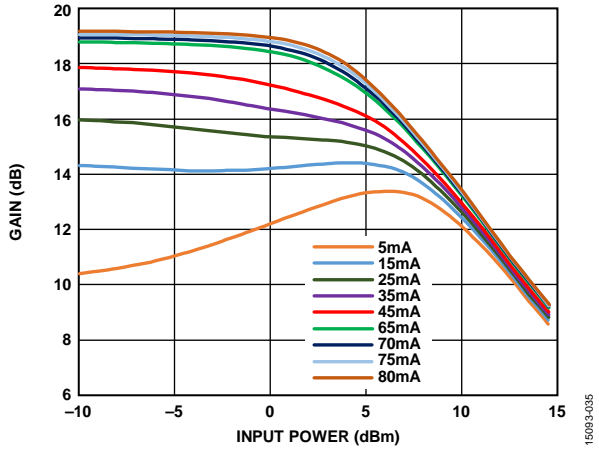

Figure 35. Gain vs. Input Power for Various Supply Currents ( $I_{DQ}$ ) at 5 GHz,  $V_{DD} = 5 V$

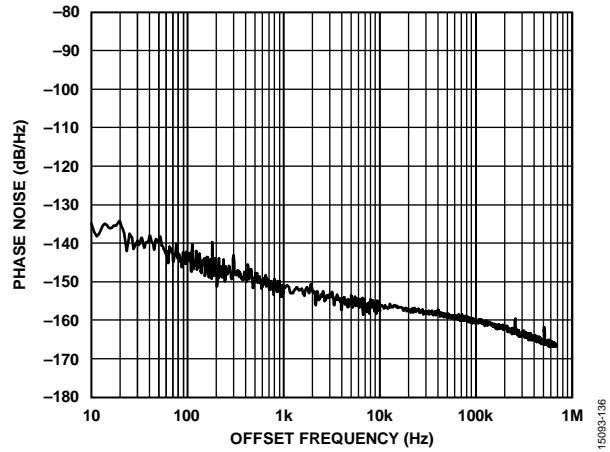

Figure 36. Additive Phase Noise vs. Offset Frequency, RF Frequency = 5 GHz, RF Input Power = 3 dBm ( $P_{1dB}$ )

## THEORY OF OPERATION

The [HMC8410CHIPS](#) is a GaAs, MMIC, pHEMT, low noise wideband amplifier.

The cascode amplifier uses a fundamental cell of two field effect transistors (FETs) in series, source to drain. The basic schematic for the cascode cell is shown in Figure 37, which forms a low noise amplifier operating from 0.01 GHz to 10 GHz with excellent noise figure performance.

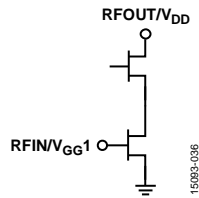

Figure 37. Basic Schematic for the Cascode Cell

The [HMC8410CHIPS](#) has single-ended input and output ports whose impedances are nominally equal to  $50\ \Omega$  over the 0.01 GHz to 10 GHz frequency range. Consequently, it can directly insert into a  $50\ \Omega$  system with no required impedance matching circuitry, which also means that multiple [HMC8410CHIPS](#) amplifiers can be cascaded back to back without the need for external matching circuitry.

The input and output impedances are sufficiently stable vs. variations in temperature and supply voltage so that no impedance matching compensation is required.

To achieve optimal performance from the [HMC8410CHIPS](#) and prevent damage to the device, do not exceed the absolute maximum ratings.

## APPLICATIONS INFORMATION

Figure 40 shows the basic connections for operating the HMC8410CHIPS. The data taken herein used wideband bias tees on the input and output ports to provide both ac coupling and the necessary supply voltages to the RFIN/V<sub>GG1</sub> and RFOUT/V<sub>DD</sub> pins. A 5 V dc drain bias is supplied to the amplifier through the choke inductor connected to the RFOUT/V<sub>DD</sub> pin, and the -2 V gate bias voltage is supplied to the RFIN/V<sub>GG1</sub> pin through the choke inductor. The RF signal must be ac-coupled to prevent disrupting the dc bias applied to the RFIN/V<sub>GG1</sub> and RFOUT/V<sub>DD</sub> pins. The nonideal characteristics of ac coupling capacitors and choke inductors (for example, self resonance) can introduce performance trade-offs that must be considered when using a single application circuit across a wide frequency range.

### RECOMMENDED BIAS SEQUENCING

The recommended bias sequence during power-up is as follows:

1. Connect to GND.
2. Set RFIN/V<sub>GG1</sub> to -2 V.
3. Set RFOUT/V<sub>DD</sub> to 5 V.
4. Increase RFIN/V<sub>GG1</sub> to achieve a typical supply current ( $I_{DQ}$ ) = 65 mA.
5. Apply the RF signal.

The recommended bias sequence during power-down is as follows:

1. Turn off the RF signal.
2. Decrease RFIN/V<sub>GG1</sub> to -2 V to achieve a typical  $I_{DQ}$  = 0 mA.
3. Decrease RFOUT/V<sub>DD</sub> to 0 V.
4. Increase RFIN/V<sub>GG1</sub> to 0 V.

The bias conditions previously listed (RFOUT/V<sub>DD</sub> = 5 V and  $I_{DQ}$  = 65 mA) are the recommended operating conditions to achieve optimum performance. The data used in this data sheet was taken with the recommended bias conditions. When using the HMC8410CHIPS with different bias conditions, different performance than that shown in the Typical Performance Characteristics section can result.

Figure 29, Figure 30, and Figure 31 show that increasing the voltage from 3 V to 7 V typically increases P<sub>1dB</sub> and P<sub>SAT</sub> at the expense of power consumption with minor degradation on noise figure (NF).

### MOUNTING AND BONDING TECHNIQUES FOR MILLIMETERWAVE GaAs MMICS

Attach the die directly to the ground plane eutectically or with conductive epoxy (see the Handling Precautions section).

To bring the radio frequency to and from the chip, implementing 50 Ω transmission lines using a microstrip or coplanar waveguide on 0.127 mm (5 mil) thick alumina, thin film substrates is recommended (see Figure 38). When using 0.254 mm (10 mil) thick alumina, it is recommended that the die be raised to ensure that the die and substrate surfaces are coplanar. Raise the die 0.150 mm (6 mil) to ensure that the surface of the die is coplanar with the surface of the substrate. To accomplish this, attach the 0.102 mm (4 mil) thick die to a 0.150 mm (6 mil) thick, molybdenum (Mo) heat spreader (moly tab), which can then be attached to the ground plane (see Figure 38 and Figure 39).

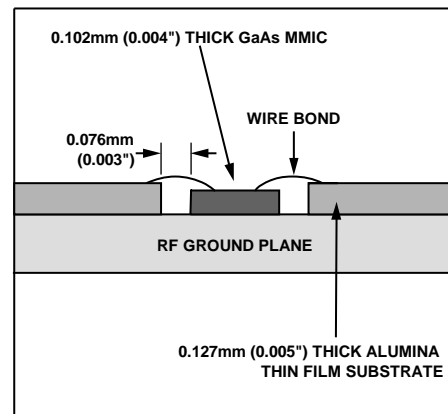

Figure 38. Die Without the Moly Tab

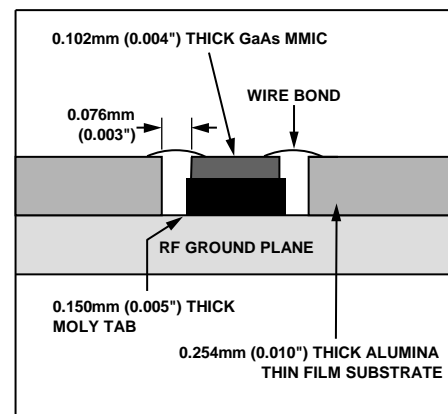

Figure 39. Die With the Moly Tab

Place microstrip substrates as close to the die as possible to minimize bond wire length. Typical die to substrate spacing is 0.076 mm to 0.152 mm (3 mil to 6 mil).

**Handling Precautions**

To avoid permanent damage, follow these storage, cleanliness, static sensitivity, transient, and general handling precautions:

- Place all bare die in either wafer or gel-based ESD protective containers and then seal the die in an ESD protective bag for shipment. After the sealed ESD protective bag is opened, store all die in a dry nitrogen environment.
- Handle the chips in a clean environment. Do not attempt to clean the chip using liquid cleaning systems.
- Follow ESD precautions to protect against ESD strikes.
- While bias is applied, suppress instrument and bias supply transients. Use shielded signal and bias cables to minimize inductive pickup.
- Handle the chip along the edges with a vacuum collet or with a sharp pair of bent tweezers. The surface of the chip can have fragile air bridges and must not be touched with a vacuum collet, tweezers, or fingers.

### APPLICATION CIRCUIT

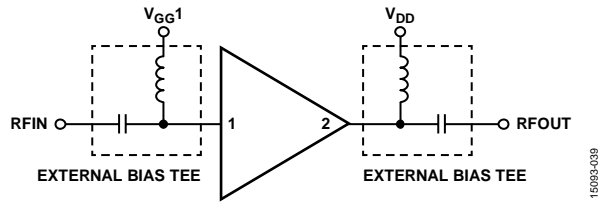

Figure 40. Application Circuit

### ASSEMBLY DIAGRAM

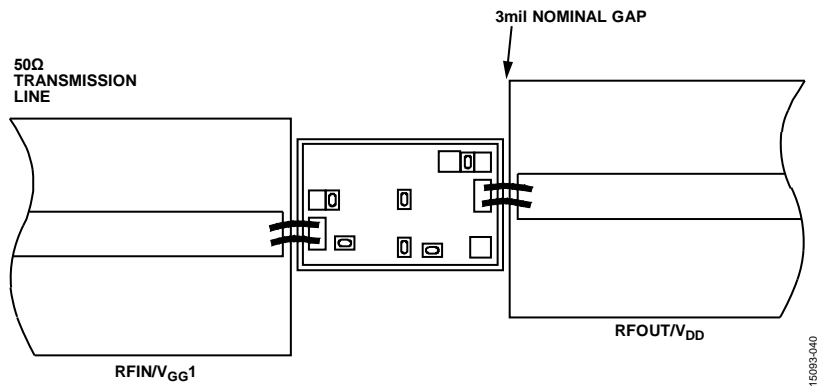

Figure 41. Assembly Diagram



# OUTLINE DIMENSIONS

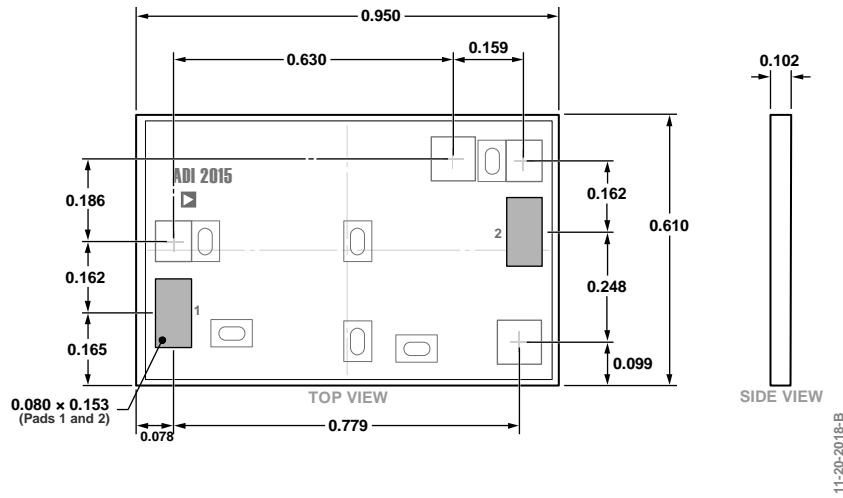

Figure 42. 2-Pad Bare Die [CHIP]  
(C-2-3)  
Dimensions shown in millimeters

## ORDERING GUIDE

Model <sup>1</sup>	Temperature Range	Package Description	Package Option
HMC8410CHIPS	-55°C to +85°C	2-Pad Bare Die [CHIP]	C-2-3
HMC8410CHIPS-SX	-55°C to +85°C	2-Pad Bare Die [CHIP]	C-2-3

<sup>1</sup> The HMC8410CHIPS and HMC8410CHIPS-SX are RoHS Compliant Parts.