

FLARE-MINI-A-PIN

~100° x 20° oval beam. Assembly with location pins and installation tape.

TECHNICAL SPECIFICATIONS:

Dimensions	Ø 16.0 mm
Height	9.1 mm
Fastening	tape, pin
Colour	clear
Box size	460 x 250 x 300 mm
Box weight	7.4 kg
Quantity in Box	4600 pcs
ROHS compliant	yes ⓘ



MATERIAL SPECIFICATIONS:

Component	Type	Material	Colour
FLARE-MINI-A-PIN	Single lens	PMMA	clear
TINA-TAPE3	Tape	PU tape	black

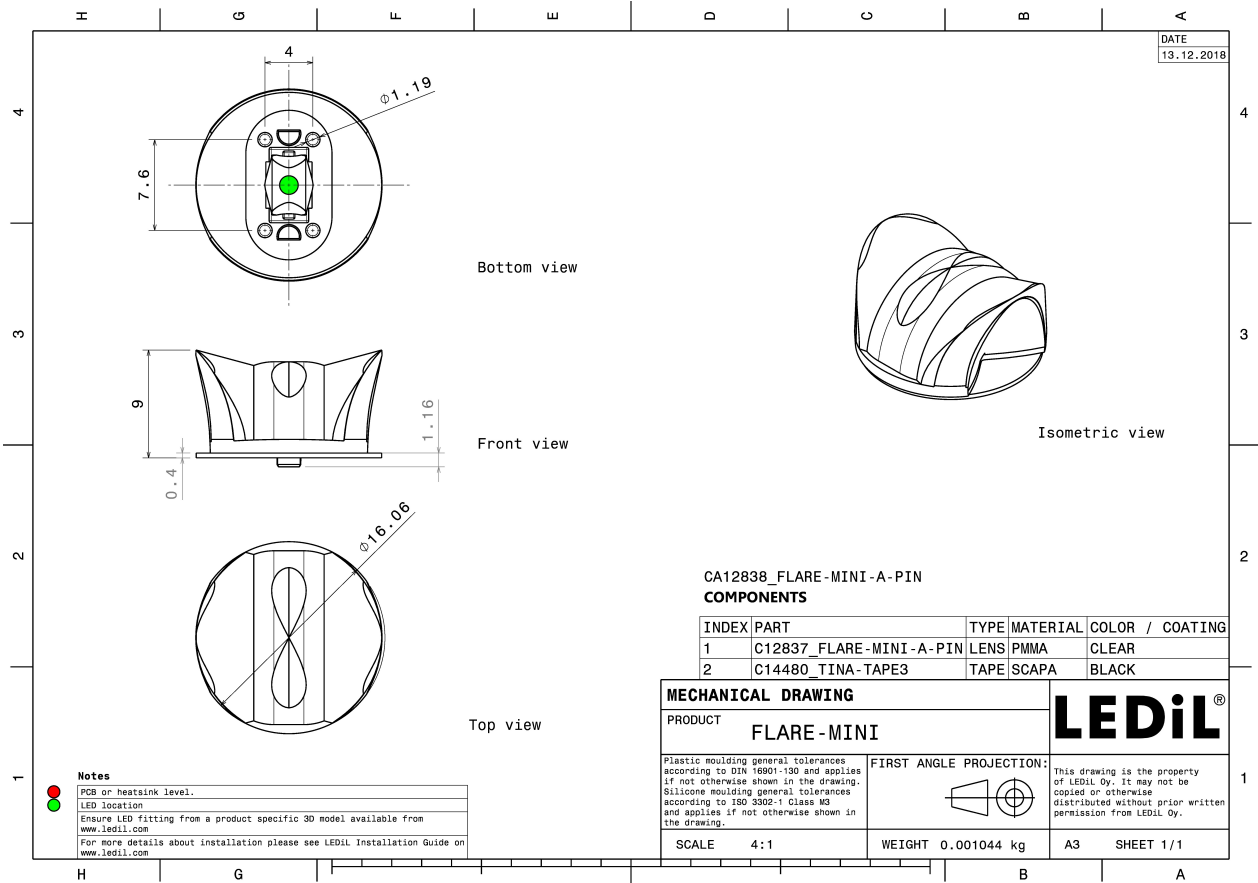

PHOTOMETRIC DATA (MEASURED):



LED XB-D
 FWHM 130.0 + 21.0°
 Efficiency 94 %
 Peak intensity 0.800 cd/lm
 LEDs/each optic 1
 Light colour White
 Required components:

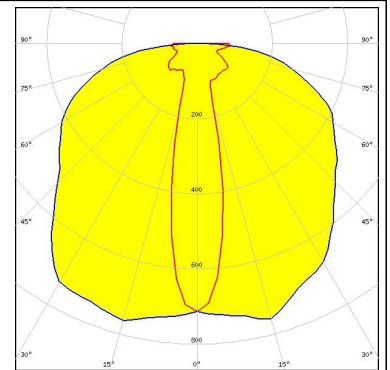
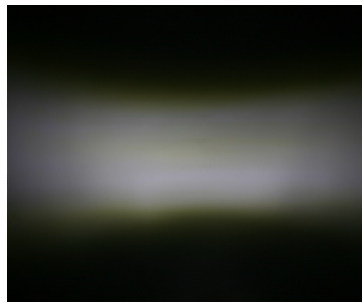

LED XP-E
 FWHM 113.0 + 20.0°
 Efficiency 94 %
 Peak intensity 0.900 cd/lm
 LEDs/each optic 1
 Light colour White
 Required components:

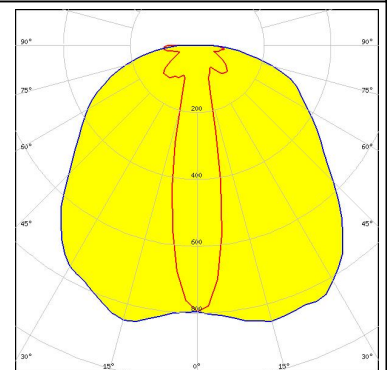
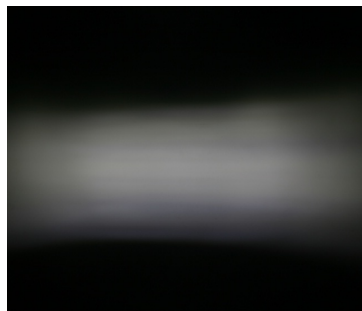

LED XP-E2
 FWHM 93.0 + 14.0°
 Efficiency 94 %
 Peak intensity 1.800 cd/lm
 LEDs/each optic 1
 Light colour White
 Required components:

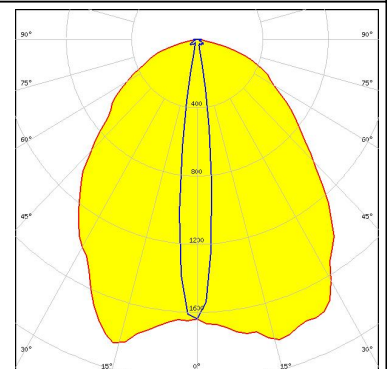
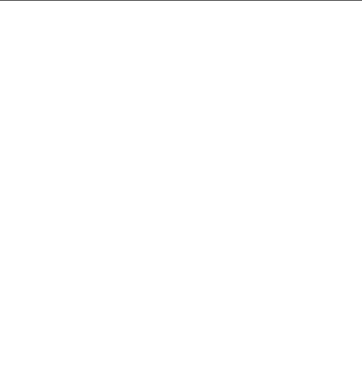

LED XP-G
 FWHM 114.0 + 22.0°
 Efficiency 94 %
 Peak intensity 0.800 cd/lm
 LEDs/each optic 1
 Light colour White
 Required components:

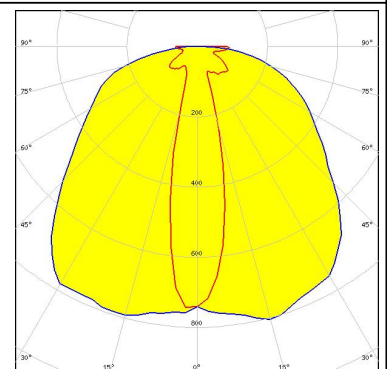
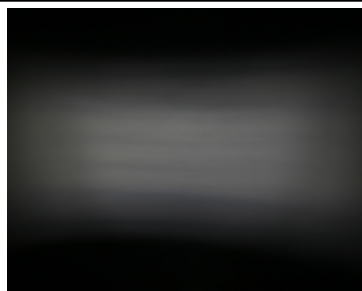

PHOTOMETRIC DATA (MEASURED):

CREE

LED XP-G2
 FWHM 94.0 + 19.0°
 Efficiency 94 %
 Peak intensity 1.300 cd/lm
 LEDs/each optic 1
 Light colour White
 Required components:

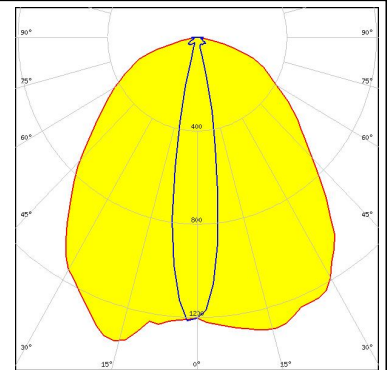

CREE

LED XP-L HD
 FWHM 113.0 + 25.0°
 Efficiency 90 %
 Peak intensity 0.790 cd/lm
 LEDs/each optic 1
 Light colour White
 Required components:

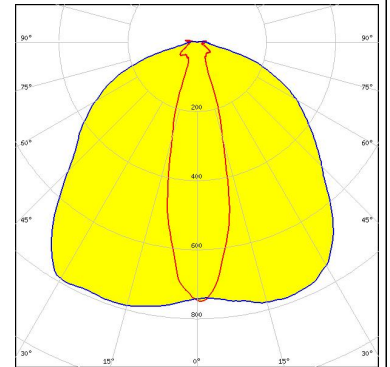
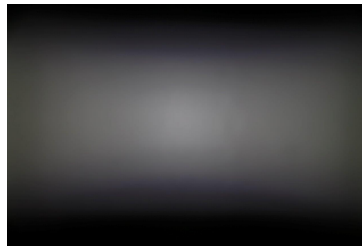

CREE

LED XP-L2
 FWHM 100.0 + 28.0°
 Efficiency 94 %
 Peak intensity 0.840 cd/lm
 LEDs/each optic 1
 Light colour White
 Required components:

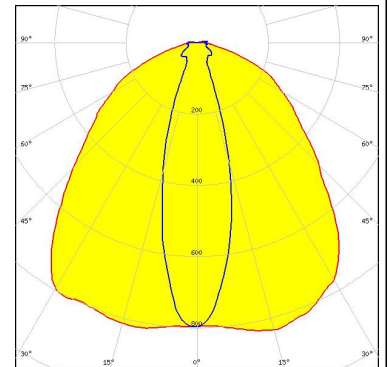
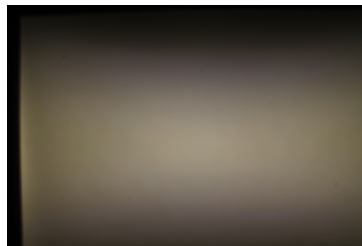

CREE

LED XT-E
 FWHM 124.0 + 22.0°
 Efficiency 94 %
 Peak intensity 0.700 cd/lm
 LEDs/each optic 1
 Light colour White
 Required components:

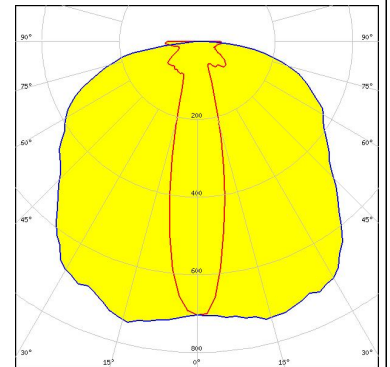
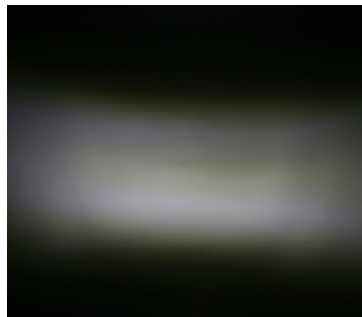

PHOTOMETRIC DATA (MEASURED):

LG Innotek

LED H35C1 (LEMWA33)
 FWHM 96.0 + 18.0°
 Efficiency 94 %
 Peak intensity 1.320 cd/lm
 LEDs/each optic 1
 Light colour White
 Required components:

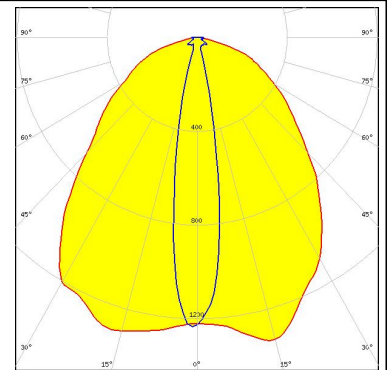
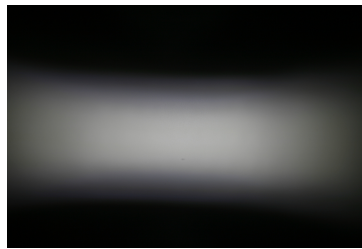

LUMILEDS

LED LUXEON CZ
 FWHM 105.0 + 9.0°
 Efficiency 94 %
 Peak intensity 2.400 cd/lm
 LEDs/each optic 1
 Light colour White
 Required components:

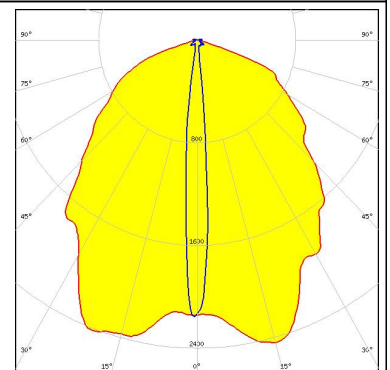

LUMILEDS

LED LUXEON Rebel ES
 FWHM 110.0 + 19.0°
 Efficiency 94 %
 Peak intensity 0.900 cd/lm
 LEDs/each optic 1
 Light colour White
 Required components:

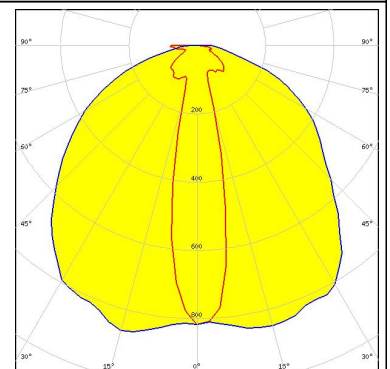

LUMILEDS

LED LUXEON T
 FWHM 95.0 + 19.0°
 Efficiency 93 %
 Peak intensity 1.300 cd/lm
 LEDs/each optic 1
 Light colour White
 Required components:

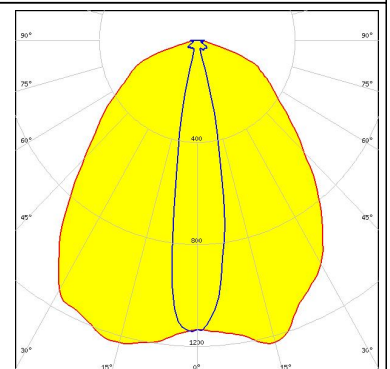

PHOTOMETRIC DATA (MEASURED):



LED LUXEON TX
 FWHM 93.0 + 19.0°
 Efficiency 94 %
 Peak intensity 1.300 cd/lm
 LEDs/each optic 1
 Light colour White
 Required components:

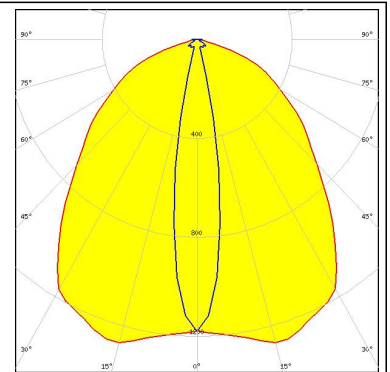
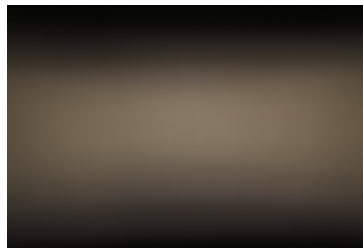

LED NCSxx19A
 FWHM 112.0 + 20.0°
 Efficiency 94 %
 Peak intensity 0.900 cd/lm
 LEDs/each optic 1
 Light colour White
 Required components:

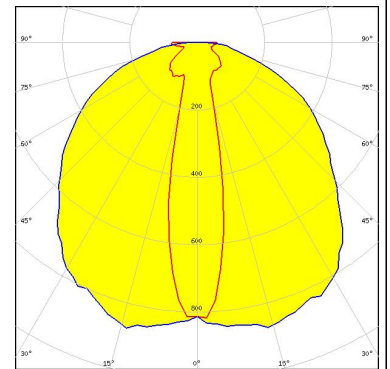
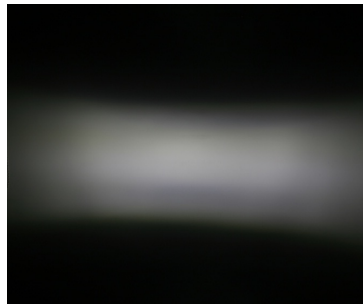

LED NCSxx19B
 FWHM 95.0 + 15.0°
 Efficiency 94 %
 Peak intensity 1.600 cd/lm
 LEDs/each optic 1
 Light colour White
 Required components:

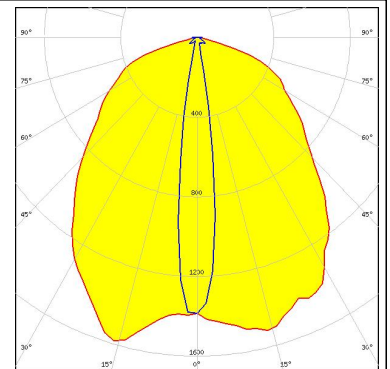
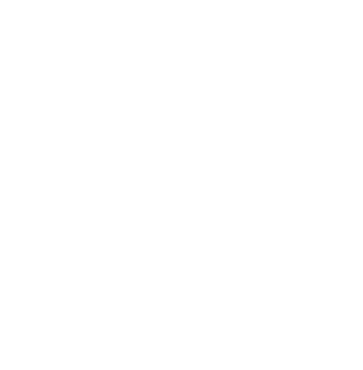

LED NVSW219F
 FWHM 99.0 + 21.0°
 Efficiency 94 %
 Peak intensity 1.100 cd/lm
 LEDs/each optic 1
 Light colour White
 Required components:

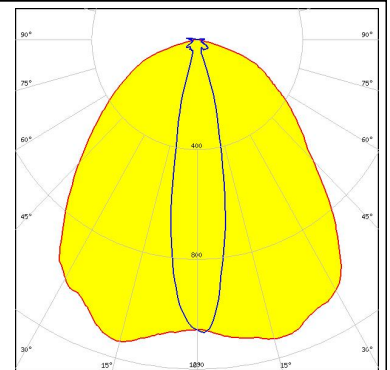
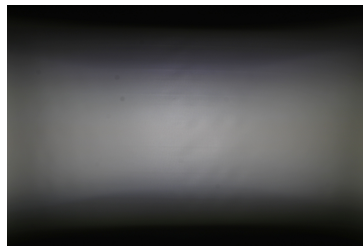

PHOTOMETRIC DATA (MEASURED):



LED NVSxx19B/NVSxx19C
 FWHM 101.0 + 20.0°
 Efficiency 94 %
 Peak intensity 1.200 cd/lm
 LEDs/each optic 1
 Light colour White
 Required components:

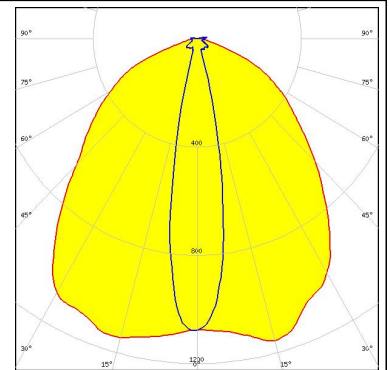
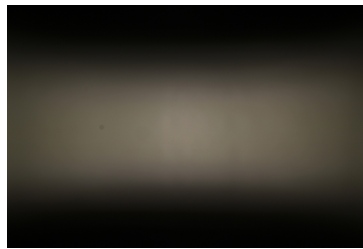

LED OSLOM Square PC
 FWHM 116.0 + 22.0°
 Efficiency 94 %
 Peak intensity 0.800 cd/lm
 LEDs/each optic 1
 Light colour White
 Required components:

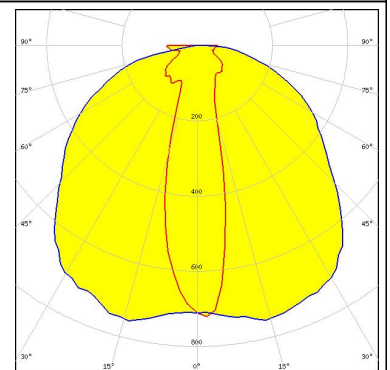
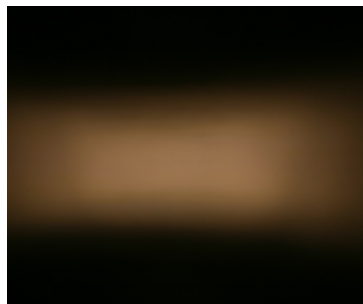

LED OSLOM SSL 150
 FWHM 106.0 + 11.0°
 Efficiency 93 %
 Peak intensity 1.700 cd/lm
 LEDs/each optic 1
 Light colour White
 Required components:

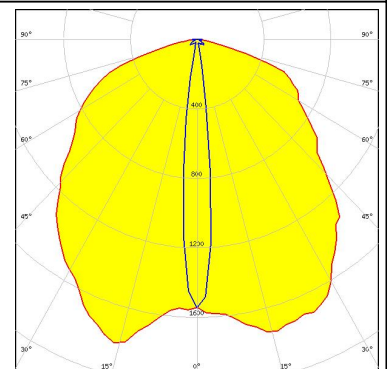
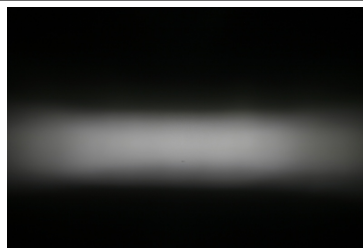

LED OSLOM SSL 80
 FWHM 84.0 + 12.0°
 Efficiency 93 %
 Peak intensity 2.000 cd/lm
 LEDs/each optic 1
 Light colour White
 Required components:

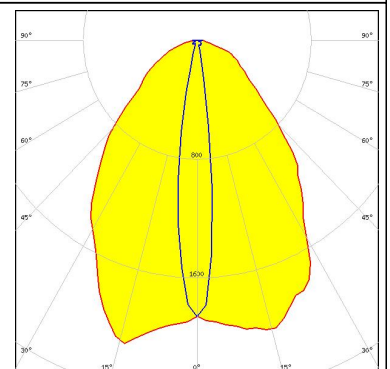
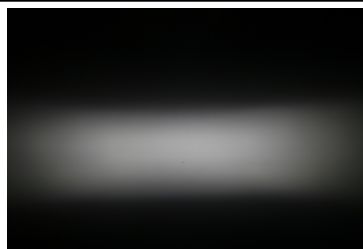

PHOTOMETRIC DATA (MEASURED):

SAMSUNG

LED LH351Z
 FWHM 95.0 + 19.0°
 Efficiency 94 %
 Peak intensity 1.500 cd/lm
 LEDs/each optic 1
 Light colour White
 Required components:

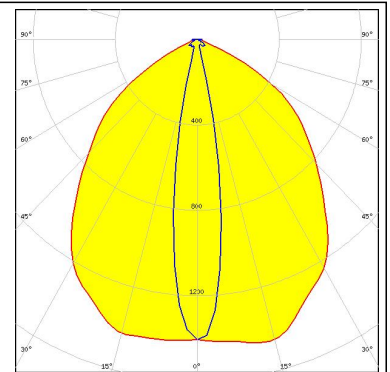

SEOUL SEMICONDUCTOR
 LED Z5M3
 FWHM 102.0 + 20.0°
 Efficiency 94 %
 Peak intensity 1.100 cd/lm
 LEDs/each optic 1
 Light colour White
 Required components:

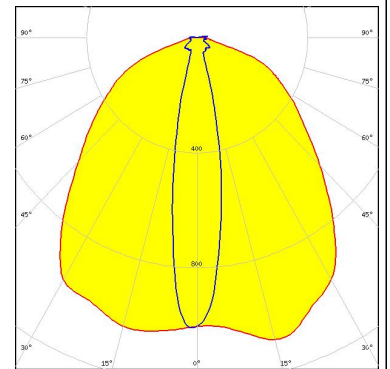

SEOUL SEMICONDUCTOR
 LED Z8Y22P
 FWHM 115.0 + 21.0°
 Efficiency 94 %
 Peak intensity 1.000 cd/lm
 LEDs/each optic 1
 Light colour White
 Required components:

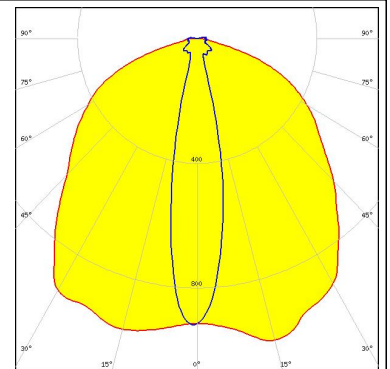
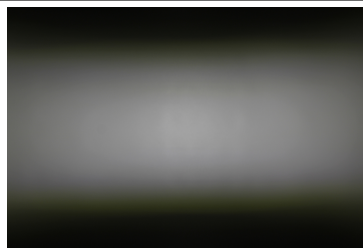

PHOTOMETRIC DATA (SIMULATED):



LED XP-G3
FWHM 93.0 + 20.0°
Efficiency 94 %
Peak intensity 1.130 cd/lm
LEDs/each optic 1
Light colour White
Required components:

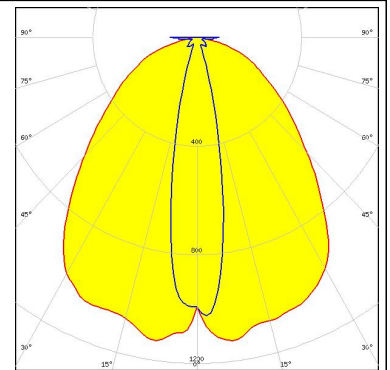

LED XQ-E HD
FWHM 78.0 + 11.0°
Efficiency 95 %
Peak intensity 2.504 cd/lm
LEDs/each optic 1
Light colour White
Required components:

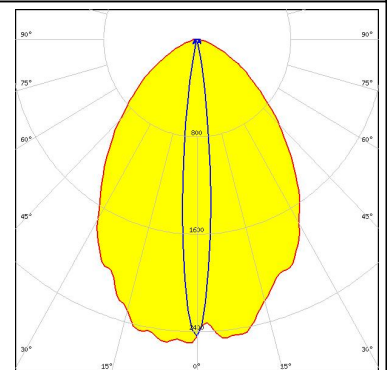

LED LUXEON C
FWHM 11.0 + 84.0°
Efficiency 92 %
Peak intensity 1.600 cd/lm
LEDs/each optic 1
Light colour White
Required components:

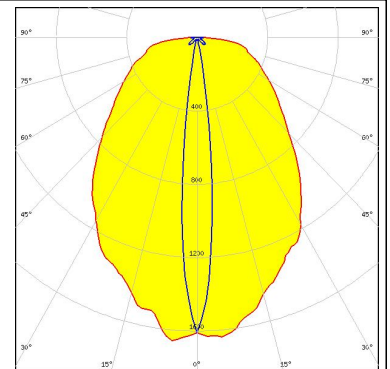

LED LUXEON H50-2
FWHM 18.0 + 86.0°
Efficiency 93 %
Peak intensity 1.450 cd/lm
LEDs/each optic 1
Light colour White
Required components:

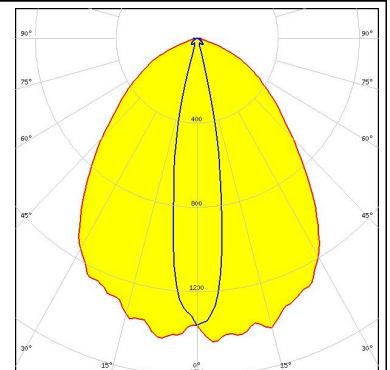

PHOTOMETRIC DATA (SIMULATED):



LED NVSxE21A
FWHM 91.0 + 16.0°
Efficiency 94 %
Peak intensity 1.540 cd/lm
LEDs/each optic 1
Light colour White
Required components:

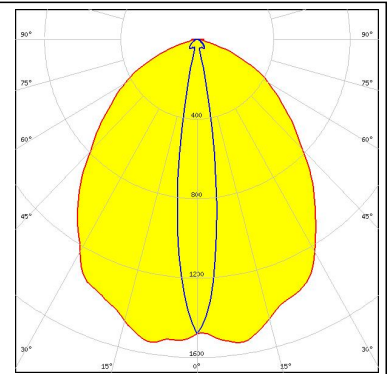

GENERAL INFORMATION:

NOTE: The typical beam angle will be changed by different color, chip size and chip position tolerance. The typical total beam angle is the full angle measured where the luminous intensity is half of the peak value.

MATERIALS:

As part of our continuous research and improvement processes, and to ensure the best possible quality and availability of our products, LEDiL reserves the right to change material grades without notice.

PRODUCT DATA USER AGREEMENT AND DISCLAIMER:

The measured data in the provided downloadable LEDiL Product Datasheets and Mechanical 2D-Drawings is rounded and provided as reference for planning. LEDiL Oy's optical specifications have been verified by conducting performance testing of the products in accordance with the company's quality system. The reported data are averaged results of multiple measurements with typical variation. LEDiL Oy reserves the right to without prior notification make changes and improvements to its products.

LEDiL Oy assumes neither warranty, nor guarantee nor any other liability of any kind for the contents and correctness of the provided data. The provided data has been generated with highest diligence but the provided data may in reality not represent the complete possible variation range of all intrinsic parameters. Therefore, in certain cases a deviation from the provided data could occur.

LEDiL Oy reserves the right to undertake technical changes of its products without further notification which could lead to changes in the provided data. LEDiL Oy assumes no liability of any kind for the possible deviation from any provided data or any other damage resulting from the usage of the provided data.

The user agrees to this disclaimer and user agreement with the download or usage of the provided files.

LEDiL Oy

Joensuunkatu 13
FI-24240 SALO
Finland

LEDiL Inc.

228 West Page Street
Suite D
Sycamore IL 60178
USA

Local sales and technical support

[www.ledil.com/
where_to_buy](http://www.ledil.com/where_to_buy)

Shipping locations

Salo, Finland
Hong Kong, China

Distribution Partners

[www.ledil.com/
where_to_buy](http://www.ledil.com/where_to_buy)