

Standard 25 A 800 V SCR

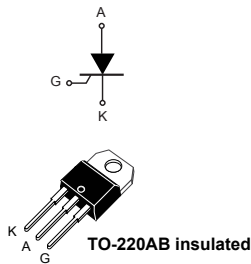

Features

- On-state RMS current, $I_{T(RMS)}$ 25 A
- Max. junction temperature = 125 °C
- Max. blocking voltage = V_{DRM} , V_{RRM} = 800 V
- I_{GT} maximum = 40 mA
- High immunity dV/dt = 1500 V/ μ s
- ECOPACK[®]2 compliant component (RoHS and HF compliance)
- Packaged in an insulated TO-220AB
 - Insulating voltage 2500 V_{RMS}
 - UL1557 certified (file ref. E81734)

Applications

- Solid State Relay (SSR)
- Bypass
- AC DC Inrush Current Limiter (ICL)
- Battery Charger
- AC DC voltage controlled rectifier
- Off board automotive battery charger
- Motor soft starter

Description

Available in through-hole package, the TXN825RG is suitable for general purpose applications.

It uses clip assembly technology, therefore the performance is superior in surge current capabilities.

Housed in a TO-220AB ceramic insulated, this device provides an improved thermal resistance.

Product status link	
TXN825RG	
Product summary	
Symbol	Value
$I_{T(RMS)}$	25 A
V_{DRM}/V_{RRM}	800 V
I_{GT}	40 mA
T_j	125 °C

1 TXN825RG Characteristics

Table 1. Absolute ratings (limiting values), $T_j = 25\text{ °C}$ unless otherwise specified

Symbol	Parameter		Value	Unit
$I_{T(RMS)}$	RMS on-state current (180° conduction angle)	$T_C = 83\text{ °C}$	25	A
$I_{T(AV)}$	Average on-state current (180° conduction angle)		16	
I_{TSM}	Non repetitive surge peak on-state current	$t_p = 10\text{ ms}$	300	A
		$t_p = 8.3\text{ ms}$	314	
I^2t	I^2t value for fusing	$t_p = 10\text{ ms}$	450	A^2s
di/dt	Critical rate of rise of on-state current $I_G = 2 \times I_{GT}$, $t_r \leq 100\text{ ns}$	$f = 50\text{ Hz}$	50	$A/\mu s$
V_{DRM} / V_{RRM}	Repetitive surge peak off-state voltage (50-60 Hz)	$T_j = 125\text{ °C}$	800	V
I_{GM}	Peak gate current	$t_p = 20\text{ }\mu s$ $T_j = 125\text{ °C}$	4	A
$P_{G(AV)}$	Average gate power dissipation	$T_j = 125\text{ °C}$	1	W
T_{stg}	Storage junction temperature range		-40 to +150	$^{\circ}C$
T_j	Operating junction temperature range		-40 to +125	$^{\circ}C$
V_{RGM}	Maximum peak reverse gate voltage		5	V
V_{INS}	Insulation RMS voltage, 1 minute, UL1557 certified E81734		2.5	kV

Table 2. Electrical characteristics ($T_j = 25\text{ °C}$ unless otherwise specified)

Symbol	Test conditions		Value	Unit	
I_{GT}	$V_D = 12\text{ V}$, $R_L = 30\text{ }\Omega$	Min.	4	mA	
		Max.	40		
V_{GT}		Max.	1.3	V	
V_{GD}	$V_D = V_{DRM}$, $R_L = 3.3\text{ k}\Omega$, $T_j = 125\text{ °C}$	Max.	0.2	V	
I_H	$I_T = 500\text{ mA}$, gate open	Max.	50	mA	
I_L	$I_G = 1.2 \times I_{GT}$	Max.	90	mA	
dV/dt	$V_D = 536\text{ V}$, gate open	$T_j = 125\text{ °C}$	Min.	1500	$V/\mu s$

Table 3. Static characteristics

Symbol	Test conditions		Value	Unit	
V_{TM}	$I_{TM} = 50\text{ A}$, $t_p = 380\text{ }\mu s$	$T_j = 25\text{ °C}$	Max.	1.60	V
V_{t0}	Threshold voltage	$T_j = 125\text{ °C}$	Max.	0.77	V
R_d	Dynamic resistance	$T_j = 125\text{ °C}$	Max.	14	$m\Omega$
I_{DRM} / I_{RRM}	$V_{DRM} = V_{RRM} = 800\text{ V}$	$T_j = 25\text{ °C}$	Max.	5	μA
		$T_j = 125\text{ °C}$	Max.	4	mA

Table 4. Thermal parameters

Symbol	Parameter	Value	Unit
$R_{th(j-c)}$	Thermal resistance Junction to case (DC)	2.0	°C/W
$R_{th(j-a)}$	Junction to ambient (DC)	60	

1.1 Characteristics (curves)

Figure 1. Maximum average power dissipation versus average on-state current

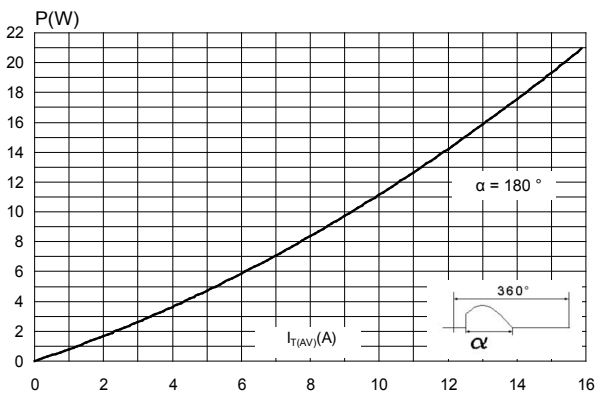

Figure 2. Average and D.C. on-state current versus case temperature

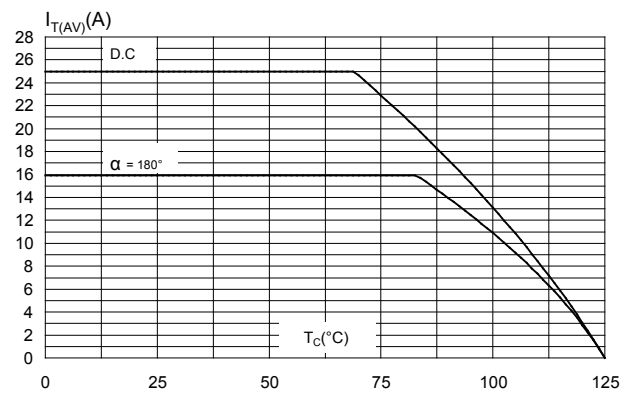

Figure 3. Average and D.C. on-state current versus ambient temperature

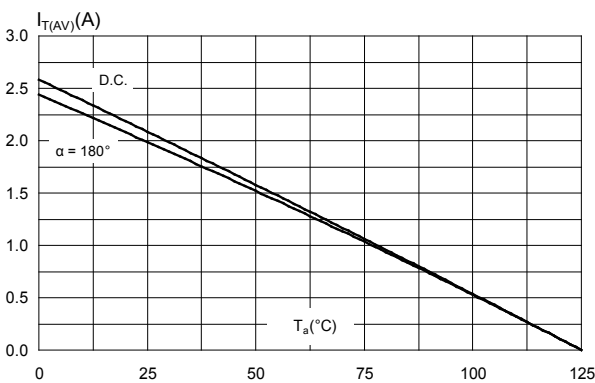

Figure 4. Relative variation of thermal impedance junction to case and junction to ambient versus pulse duration

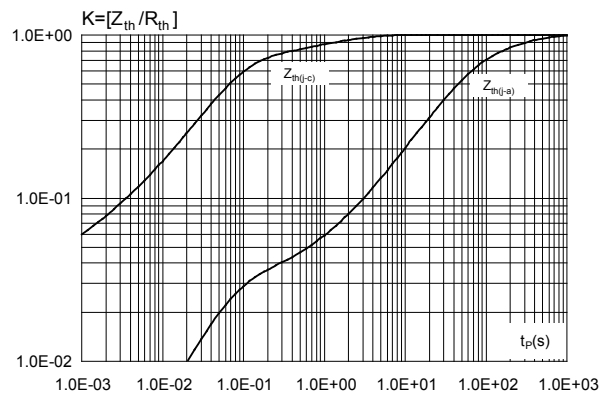

Figure 5. Relative variation of gate trigger and holding current versus junction temperature

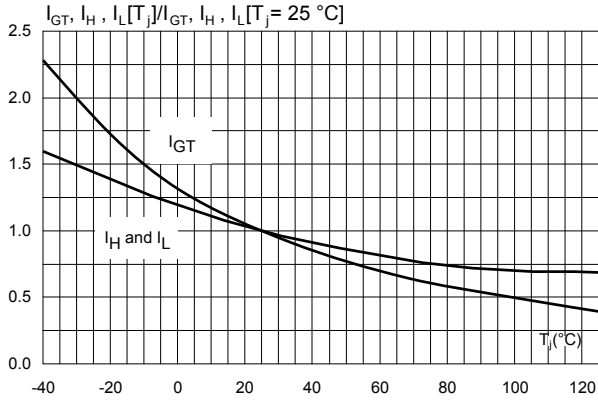

Figure 6. Surge peak on-state current versus number of cycles

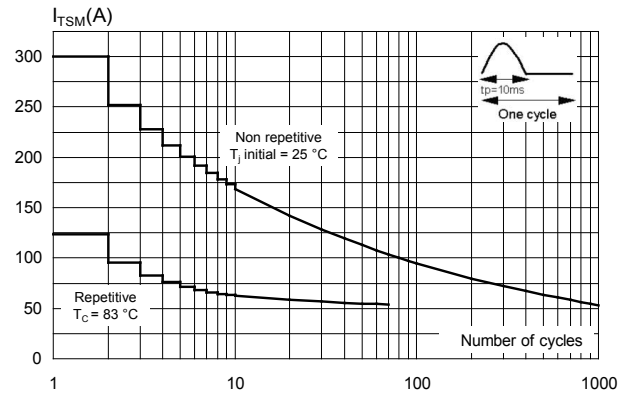

Figure 7. Non-repetitive surge peak on-state current for a sinusoidal pulse with width $t_p < 10$ ms

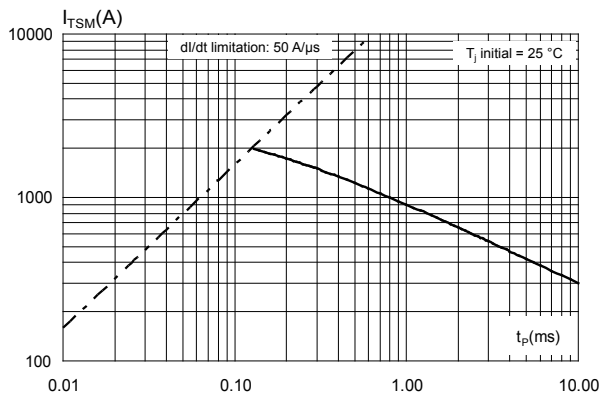
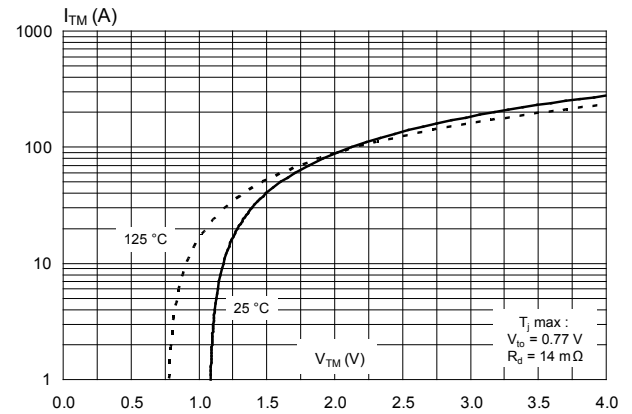

Figure 8. On-state characteristics (maximum values)



2 Package information

In order to meet environmental requirements, ST offers these devices in different grades of ECOPACK® packages, depending on their level of environmental compliance. ECOPACK® specifications, grade definitions and product status are available at: www.st.com. ECOPACK® is an ST trademark.

2.1 TO-220AB insulated package information

- Epoxy resin is halogen free and meets UL94 flammability standard, level V0
- Lead-free plating package leads
- Recommended torque: 0.4 to 0.6 N·m

Figure 9. TO-220AB Insulated package outline

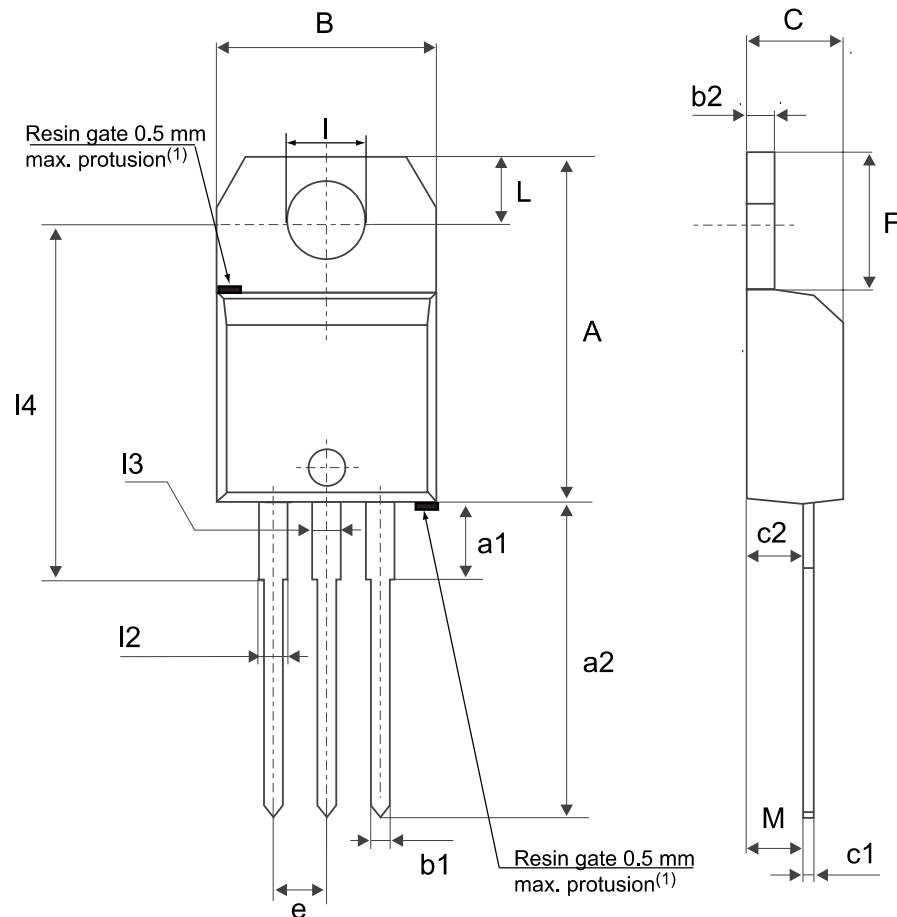

(1) Resin gate position accepted in one of the two positions or in the symmetrical opposites.

Table 5. TO-220AB Insulated package mechanical data

Ref.	Dimensions					
	Millimeters			Inches ⁽¹⁾		
	Min.	Typ.	Max.	Min.	Typ.	Max.
A	15.20		15.90	0.5984		0.6260
a1		3.75			0.1476	
a2	13.00		14.00	0.5118		0.5512
B	10.00		10.40	0.3937		0.4094
b1	0.61		0.88	0.0240		0.0346
b2	1.23		1.32	0.0484		0.0520
C	4.40		4.60	0.1732		0.1811
c1	0.49		0.70	0.0193		0.0276
c2	2.40		2.72	0.0945		0.1071
e	2.40		2.70	0.0945		0.1063
F	6.20		6.60	0.2441		0.2598
l	3.73		3.88	0.1469		0.1528
L	2.65		2.95	0.1043		0.1161
l2	1.14		1.70	0.0449		0.0669
l3	1.14		1.70	0.0449		0.0669
l4	15.80	16.40	16.80	0.6220	0.6457	0.6614
M		2.6			0.1024	

1. Inch dimensions are for reference only.

3 TXN825RG Ordering information

Figure 10. Ordering information scheme

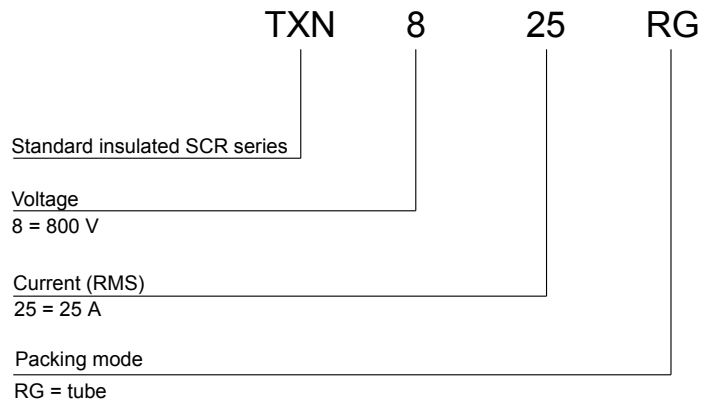

Table 6. Ordering information

Order code	Marking	Package	Weight	Base qty.	Delivery mode
TXN825RG	TXN825	TO-220AB-Ins.	2.3 g	50	Tube

Revision history

Table 7. Document revision history

Date	Revision	Changes
23-Feb-2018	1	Initial release.
01-Jun-2018	2	Removed maturity status indication from cover page. The document status is production data.

IMPORTANT NOTICE – PLEASE READ CAREFULLY

STMicroelectronics NV and its subsidiaries (“ST”) reserve the right to make changes, corrections, enhancements, modifications, and improvements to ST products and/or to this document at any time without notice. Purchasers should obtain the latest relevant information on ST products before placing orders. ST products are sold pursuant to ST’s terms and conditions of sale in place at the time of order acknowledgement.

Purchasers are solely responsible for the choice, selection, and use of ST products and ST assumes no liability for application assistance or the design of Purchasers’ products.

No license, express or implied, to any intellectual property right is granted by ST herein.

Resale of ST products with provisions different from the information set forth herein shall void any warranty granted by ST for such product.

ST and the ST logo are trademarks of ST. All other product or service names are the property of their respective owners.

Information in this document supersedes and replaces information previously supplied in any prior versions of this document.

© 2018 STMicroelectronics – All rights reserved