



Bridgelux[®] Décor Series[™] Class A on Vero[®] SE Series LED Array

Product Data Sheet DS125



BXRC-30A1001	30A2001	30A4001	30A10K1
BXRC-35A1001	35A2001	35A4001	35A10K1
BXRC-40A1001	40A2001	40A4001	40A10K1

Introduction

Vero SE



Bridgelux Décor Series™ Class A on Vero SE products are a revolutionary advancement in lighting designed to match how humans perceive and prefer light. The Class A specification was created by the Lighting Research Center (LRC) behavior studies in conjunction with Bridgelux and other ASSIST members. Based on human factor response testing, the Décor Series Class A products provide vibrant, natural and brilliant looking light, evoking an emotional attraction and response. The Décor Series Class A products were developed for high-end retail, museum, architectural, premium building and hospitality applications.

Bridgelux Décor Series Class A on Vero SE products are available on all Vero SE form factors. The platform has been engineered with poke-in connectivity options and can operate over a broad current range, enabling multiple degrees of flexibility in luminaire design optimization.

Features

- Poke-in connectivity
- Light quality is based on human perception of color and light
- High gamut area index (GAI)
- No harmful UV or near IR light in the spectrum
- Substantially broader GAI and color spectrum than halogen
- Radial die pattern enhances optical uniformity
- Based on Bridgelux Vero® Series LED array platform
- No exposed solder pads or electrical connections

Benefits

- Poke-in connectivity enables solderless, connector free installation
- Broad application coverage for interior and exterior lighting
- Flexibility for application driven lighting design requirements
- High quality, true color reproduction
- Uniform consistent white light
- Flexibility in design optimization
- Enhanced ease of use and manufacturability
- Ability to configure multiple Vero SE in series and parallel reduces customer driver cost

Contents

Product Feature Map	2
Product Nomenclature	2
Product Selection Guide	3
Performance at Commonly Used Drive Currents	7
Electrical Characteristics	11
Eye Safety	12
Absolute Maximum Ratings	13
Performance Curves	14
Typical Radiation Pattern	20
Typical Color Spectrum	22
Mechanical Dimensions	21
Packaging and Labeling	25
Design Resources	28
Precautions	28
Disclaimers	28
About Bridgelux	29

Product Feature Map

In addition to delivering the performance and light quality required for many lighting applications, Décor Series Class A on Vero SE LED arrays incorporate

several features to simplify the design integration and manufacturing process, accelerate time to market and reduce system costs.

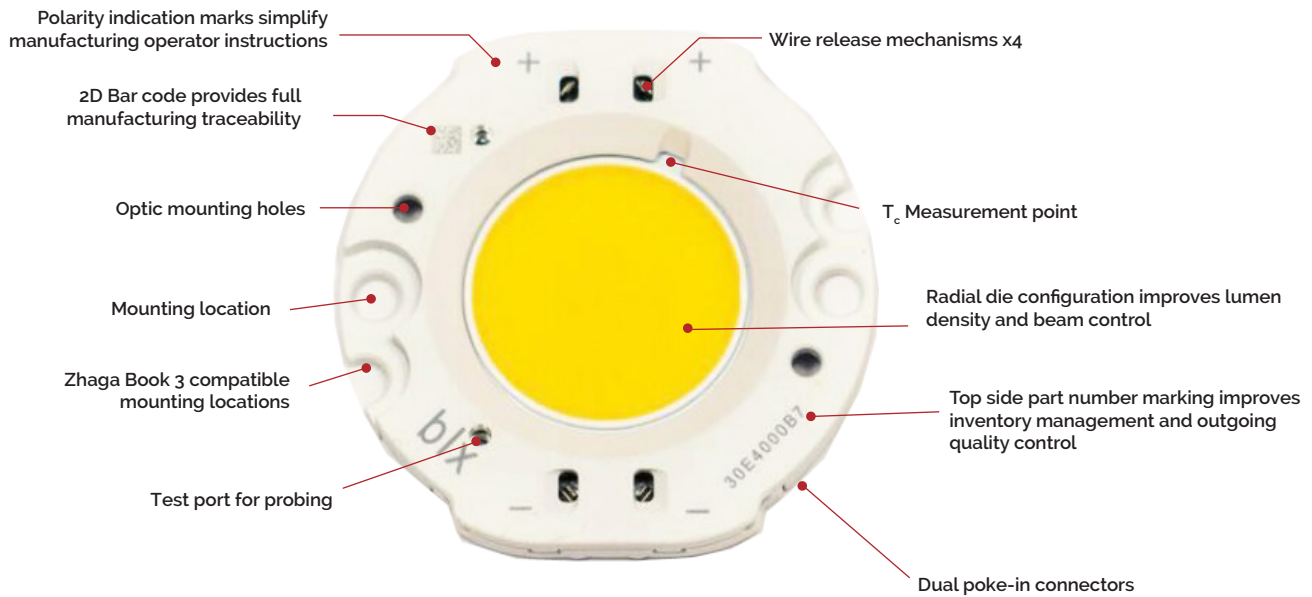

Product Nomenclature

The part number designation for Bridgelux Décor Class A on Vero SE LED arrays is explained as follows:

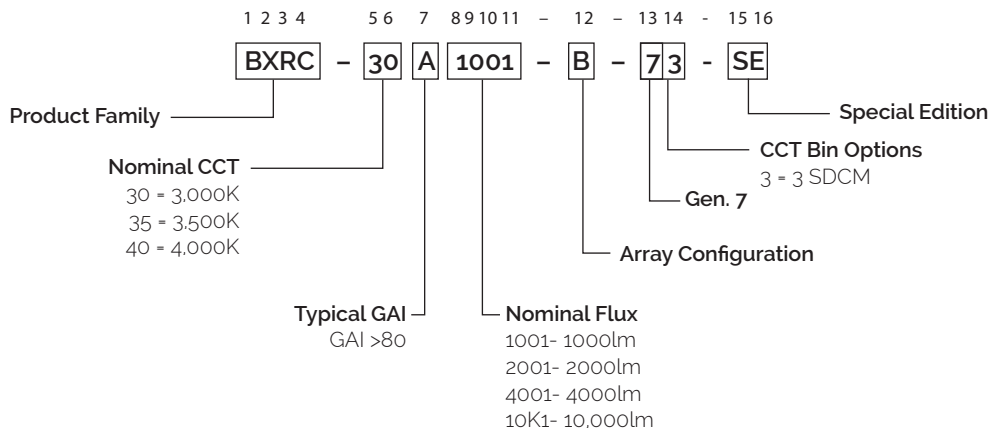

Product Selection Guide

The following product configurations are available:

Table 1: Selection Guide, Pulsed Measurement Data ($T_j = T_c = 25^\circ\text{C}$)

Product	Part Number	Nominal CCT ¹ (K)	GAI ²	CRI ³	Nominal Drive Current ⁴ (mA)	Typical Pulsed Flux ^{5,6,7} $T_c = 25^\circ\text{C}$ (lm)	Minimum Pulsed Flux ^{7,8} $T_c = 25^\circ\text{C}$ (lm)	Typical V_f (V)	Typical Power (W)	Typical Efficacy (lm/W)
Décor Class A Vero SE 10	BXRC-30A1001-B-73-SE	3000	80	93	270	1056	929	35.0	9.4	113
Décor Class A Vero SE 10	BXRC-30A1001-C-73-SE	3000	80	93	360	1407	1238	35.0	12.5	113
Décor Class A Vero SE 10	BXRC-30A1001-D-73-SE	3000	80	93	350	1026	903	26.0	9.1	113
Décor Class A Vero SE 10	BXRC-35A1001-B-73-SE	3500	80	93	270	1137	1001	35.0	9.4	122
Décor Class A Vero SE 10	BXRC-35A1001-C-73-SE	3500	80	93	360	1516	1335	35.0	12.5	122
Décor Class A Vero SE 10	BXRC-35A1001-D-73-SE	3500	80	93	350	1106	973	26.0	9.1	122
Décor Class A Vero SE 10	BXRC-40A1001-B-73-SE	4000	80	93	270	1210	1065	35.0	9.4	129
Décor Class A Vero SE 10	BXRC-40A1001-C-73-SE	4000	80	93	360	1614	1420	35.0	12.5	129
Décor Class A Vero SE 10	BXRC-40A1001-D-73-SE	4000	80	93	350	1176	1035	26.0	9.1	129
Décor Class A Vero SE 13	BXRC-30A2001-B-73-SE	3000	80	93	450	1836	1652	35.0	15.6	118
Décor Class A Vero SE 13	BXRC-30A2001-C-73-SE	3000	80	93	630	2570	2313	35.0	21.9	118
Décor Class A Vero SE 13	BXRC-30A2001-D-73-SE	3000	80	93	500	1869	1683	31.8	15.9	118
Décor Class A Vero SE 13	BXRC-35A2001-B-73-SE	3500	80	93	450	1974	1776	35.0	15.6	126
Décor Class A Vero SE 13	BXRC-35A2001-C-73-SE	3500	80	93	630	2763	2486	35.0	21.9	126
Décor Class A Vero SE 13	BXRC-35A2001-D-73-SE	3500	80	93	500	2009	1808	31.8	15.9	126
Décor Class A Vero SE 13	BXRC-40A2001-B-73-SE	4000	80	93	450	2111	1900	35.0	15.6	135
Décor Class A Vero SE 13	BXRC-40A2001-C-73-SE	4000	80	93	630	2955	2660	35.0	21.9	135
Décor Class A Vero SE 13	BXRC-40A2001-D-73-SE	4000	80	93	500	2150	1936	31.8	15.9	135
Décor Class A Vero SE 18	BXRC-30A4001-B-73-SE	3000	80	93	900	3696	3327	35.0	31.2	118
Décor Class A Vero SE 18	BXRC-30A4001-C-73-SE	3000	80	93	1170	4807	4326	35.0	40.6	118
Décor Class A Vero SE 18	BXRC-30A4001-D-73-SE	3000	80	93	1050	3594	3234	29.0	30.4	118
Décor Class A Vero SE 18	BXRC-35A4001-B-73-SE	3500	80	93	900	3974	3576	35.0	31.2	127
Décor Class A Vero SE 18	BXRC-35A4001-C-73-SE	3500	80	93	1170	5167	4650	35.0	40.6	127
Décor Class A Vero SE 18	BXRC-35A4001-D-73-SE	3500	80	93	1050	3864	3477	29.0	30.4	127
Décor Class A Vero SE 18	BXRC-40A4001-B-73-SE	4000	80	93	900	4251	3826	35.0	31.2	136
Décor Class A Vero SE 18	BXRC-40A4001-C-73-SE	4000	80	93	1170	5527	4974	35.0	40.6	136
Décor Class A Vero SE 18	BXRC-40A4001-D-73-SE	4000	80	93	1050	4134	3720	29.0	30.4	136
Décor Class A Vero SE 29	BXRC-30A10K1-B-73-SE	3000	80	93	1800	11209	10088	52.0	93.6	120
Décor Class A Vero SE 29	BXRC-30A10K1-C-73-SE	3000	80	93	1710	14197	12778	69.4	118.6	120
Décor Class A Vero SE 29	BXRC-30A10K1-D-73-SE	3000	80	93	2100	9444	8500	37.6	78.9	120
Décor Class A Vero SE 29	BXRC-35A10K1-B-73-SE	3500	80	93	1800	12050	10845	52.0	93.6	129
Décor Class A Vero SE 29	BXRC-35A10K1-C-73-SE	3500	80	93	1710	15263	13737	69.4	118.6	129
Décor Class A Vero SE 29	BXRC-35A10K1-D-73-SE	3500	80	93	2100	10153	9137	37.6	78.9	129
Décor Class A Vero SE 29	BXRC-40A10K1-B-73-SE	4000	80	93	1800	12890	11601	52.0	93.6	138
Décor Class A Vero SE 29	BXRC-40A10K1-C-73-SE	4000	80	93	1710	16327	14694	69.4	118.6	138
Décor Class A Vero SE 29	BXRC-40A10K1-D-73-SE	4000	80	93	2100	10861	9775	37.6	78.9	138

Notes for Table 1:

- Nominal CCT is defined by the Lighting Research Center's Class A definition. The center of the Class A color bin is on the corresponding isothermal line.
- To help ensure optimal fixture level performance, GAI is measured at the fixture level, on axis, at a case temperature of 70°C. GAI may vary depending on fixture design and performance.
- CRI Values are specified as typical.
- Drive current is referred to as nominal drive current.
- Products tested under pulsed condition (10ms pulse width) at nominal test current where T_j (junction temperature) - T_c (case temperature) = 25°C.
- Typical performance values are provided as a reference only and are not a guarantee of performance.
- Bridgelux maintains a ±7% tolerance on flux measurements.
- Minimum flux values at the nominal test current are guaranteed by 100% test.

Product Selection Guide

The following product configurations are available:

Table 2: Selection Guide, Stabilized DC Performance ($T_c = 70^\circ\text{C}$)^{4,5}

Product	Part Number	Nominal CCT ¹ (K)	GAI ²	CRI ³	Nominal Drive Current ⁴ (mA)	Typical DC Flux $T_c = 70^\circ\text{C}$ (lm)	Minimum DC Flux ⁶ $T_c = 70^\circ\text{C}$ (lm)	Typical V_f (V)	Typical Power (W)	Typical Efficacy (lm/W)
Décor Class A Vero SE 10	BXRC-30A1001-B-73-SE	3000	80	93	270	982	864	34.3	9.3	106
Décor Class A Vero SE 10	BXRC-30A1001-C-73-SE	3000	80	93	360	1309	1152	34.3	12.3	106
Décor Class A Vero SE 10	BXRC-30A1001-D-73-SE	3000	80	93	350	955	840	25.5	8.9	107
Décor Class A Vero SE 10	BXRC-35A1001-B-73-SE	3500	80	93	270	1058	931	34.3	9.3	114
Décor Class A Vero SE 10	BXRC-35A1001-C-73-SE	3500	80	93	360	1410	1241	34.3	12.3	114
Décor Class A Vero SE 10	BXRC-35A1001-D-73-SE	3500	80	93	350	1029	905	25.5	8.9	115
Décor Class A Vero SE 10	BXRC-40A1001-B-73-SE	4000	80	93	270	1125	991	34.3	9.3	122
Décor Class A Vero SE 10	BXRC-40A1001-C-73-SE	4000	80	93	360	1501	1321	34.3	12.3	122
Décor Class A Vero SE 10	BXRC-40A1001-D-73-SE	4000	80	93	350	1094	963	25.5	8.9	123
Décor Class A Vero SE 13	BXRC-30A2001-B-73-SE	3000	80	93	450	1707	1537	34.4	15.5	110
Décor Class A Vero SE 13	BXRC-30A2001-C-73-SE	3000	80	93	630	2390	2151	34.4	21.6	110
Décor Class A Vero SE 13	BXRC-30A2001-D-73-SE	3000	80	93	500	1738	1565	31.2	15.6	111
Décor Class A Vero SE 13	BXRC-35A2001-B-73-SE	3500	80	93	450	1836	1651	34.4	15.5	119
Décor Class A Vero SE 13	BXRC-35A2001-C-73-SE	3500	80	93	630	2569	2312	34.4	21.6	119
Décor Class A Vero SE 13	BXRC-35A2001-D-73-SE	3500	80	93	500	1868	1682	31.2	15.6	120
Décor Class A Vero SE 13	BXRC-40A2001-B-73-SE	4000	80	93	450	1963	1767	34.4	15.5	127
Décor Class A Vero SE 13	BXRC-40A2001-C-73-SE	4000	80	93	630	2748	2474	34.4	21.6	127
Décor Class A Vero SE 13	BXRC-40A2001-D-73-SE	4000	80	93	500	2000	1800	31.2	15.6	128
Décor Class A Vero SE 18	BXRC-30A4001-B-73-SE	3000	80	93	900	3438	3094	34.3	30.9	111
Décor Class A Vero SE 18	BXRC-30A4001-C-73-SE	3000	80	93	1170	4470	4023	34.3	40.2	111
Décor Class A Vero SE 18	BXRC-30A4001-D-73-SE	3000	80	93	1050	3342	3008	28.5	29.9	112
Décor Class A Vero SE 18	BXRC-35A4001-B-73-SE	3500	80	93	900	3696	3326	34.3	30.9	120
Décor Class A Vero SE 18	BXRC-35A4001-C-73-SE	3500	80	93	1170	4805	4324	34.3	40.2	120
Décor Class A Vero SE 18	BXRC-35A4001-D-73-SE	3500	80	93	1050	3594	3234	28.5	29.9	120
Décor Class A Vero SE 18	BXRC-40A4001-B-73-SE	4000	80	93	900	3953	3558	34.3	30.9	128
Décor Class A Vero SE 18	BXRC-40A4001-C-73-SE	4000	80	93	1170	5140	4626	34.3	40.2	128
Décor Class A Vero SE 18	BXRC-40A4001-D-73-SE	4000	80	93	1050	3844	3460	28.5	29.9	129
Décor Class A Vero SE 29	BXRC-30A10K1-B-73-SE	3000	80	93	1800	10424	9382	50.9	91.6	114
Décor Class A Vero SE 29	BXRC-30A10K1-C-73-SE	3000	80	93	1710	13204	11884	67.9	116.1	114
Décor Class A Vero SE 29	BXRC-30A10K1-D-73-SE	3000	80	93	2100	8783	7905	36.8	77.3	114
Décor Class A Vero SE 29	BXRC-35A10K1-B-73-SE	3500	80	93	1800	11206	10086	50.9	91.6	122
Décor Class A Vero SE 29	BXRC-35A10K1-C-73-SE	3500	80	93	1710	14194	12775	67.9	116.1	122
Décor Class A Vero SE 29	BXRC-35A10K1-D-73-SE	3500	80	93	2100	9442	8498	36.8	77.3	122
Décor Class A Vero SE 29	BXRC-40A10K1-B-73-SE	4000	80	93	1800	11987	10789	50.9	91.6	131
Décor Class A Vero SE 29	BXRC-40A10K1-C-73-SE	4000	80	93	1710	15184	13666	67.9	116.1	131
Décor Class A Vero SE 29	BXRC-40A10K1-D-73-SE	4000	80	93	2100	10101	9090	36.8	77.3	131

Notes for Table 2:

- Nominal CCT is defined by the Lighting Research Center's Class A definition. The center of the Class A color bin is on the corresponding isothermal line.
- To help ensure optimal fixture level performance, GAI is measured at the fixture level, on axis, at a case temperature of 70°C. GAI may vary depending on fixture design and performance.
- CRI Values are specified as typical.
- Drive current is referred to as nominal drive current.
- Typical performance values are provided as a reference only and are not a guarantee of performance.
- Bridgelux maintains a ±7% tolerance on flux measurements.
- Typical stabilized DC performance values are provided as reference only and are not a guarantee of performance.
- Typical performance is estimated based on operation under DC (direct current) with LED array mounted onto a heat sink with thermal interface material and the case temperature maintained at specified temperature. Based on Bridgelux test setup, values may vary depending on the thermal design of the luminaire and/or the exposed environment to which the product is subjected.
- Minimum flux values at elevated temperatures are provided for reference only and are not guaranteed by 100% production testing. Based on Bridgelux test setup, values may vary depending on the thermal design of the luminaire and/or the exposed environment to which the product is subjected.

Product Selection Guide

The following product configurations are available:

Table 3: Selection Guide, Pulsed Measurement Data ($T_j = T_c = 85^\circ\text{C}$)

Product	Part Number	Nominal CCT ¹ (K)	GAI ²	CRI ³	Nominal Drive Current ⁴ (mA)	Typical Pulsed Flux ^{5,6,7} $T_c = 85^\circ\text{C}$ (lm)	Minimum Pulsed Flux ^{7,8} $T_c = 85^\circ\text{C}$ (lm)	Typical V_f (V)	Typical Power (W)	Typical Efficacy (lm/W)
Décor Class A Vero SE 10	BXRC-30A1001-B-73-SE	3000	80	93	270	950	836	34.0	9.2	103
Décor Class A Vero SE 10	BXRC-30A1001-C-73-SE	3000	80	93	360	1267	1114	34.0	12.3	103
Décor Class A Vero SE 10	BXRC-30A1001-D-73-SE	3000	80	93	350	924	813	25.3	8.9	104
Décor Class A Vero SE 10	BXRC-35A1001-B-73-SE	3500	80	93	270	1024	901	34.0	9.2	111
Décor Class A Vero SE 10	BXRC-35A1001-C-73-SE	3500	80	93	360	1365	1201	34.0	12.3	111
Décor Class A Vero SE 10	BXRC-35A1001-D-73-SE	3500	80	93	350	996	876	25.3	8.9	112
Décor Class A Vero SE 10	BXRC-40A1001-B-73-SE	4000	80	93	270	1089	959	34.0	9.2	119
Décor Class A Vero SE 10	BXRC-40A1001-C-73-SE	4000	80	93	360	1452	1278	34.0	12.3	119
Décor Class A Vero SE 10	BXRC-40A1001-D-73-SE	4000	80	93	350	1059	932	25.3	8.9	120
Décor Class A Vero SE 13	BXRC-30A2001-B-73-SE	3000	80	93	450	1652	1487	34.1	15.4	108
Décor Class A Vero SE 13	BXRC-30A2001-C-73-SE	3000	80	93	630	2313	2082	34.1	21.5	108
Décor Class A Vero SE 13	BXRC-30A2001-D-73-SE	3000	80	93	500	1682	1514	31.0	15.5	109
Décor Class A Vero SE 13	BXRC-35A2001-B-73-SE	3500	80	93	450	1776	1598	34.1	15.4	116
Décor Class A Vero SE 13	BXRC-35A2001-C-73-SE	3500	80	93	630	2486	2238	34.1	21.5	116
Décor Class A Vero SE 13	BXRC-35A2001-D-73-SE	3500	80	93	500	1808	1627	31.0	15.5	117
Décor Class A Vero SE 13	BXRC-40A2001-B-73-SE	4000	80	93	450	1900	1710	34.1	15.4	124
Décor Class A Vero SE 13	BXRC-40A2001-C-73-SE	4000	80	93	630	2659	2394	34.1	21.5	124
Décor Class A Vero SE 13	BXRC-40A2001-D-73-SE	4000	80	93	500	1935	1742	31.0	15.5	125
Décor Class A Vero SE 18	BXRC-30A4001-B-73-SE	3000	80	93	900	3327	2994	34.1	30.7	108
Décor Class A Vero SE 18	BXRC-30A4001-C-73-SE	3000	80	93	1170	4326	3893	34.1	39.9	108
Décor Class A Vero SE 18	BXRC-30A4001-D-73-SE	3000	80	93	1050	3234	2911	28.3	29.7	109
Décor Class A Vero SE 18	BXRC-35A4001-B-73-SE	3500	80	93	900	3576	3218	34.1	30.7	117
Décor Class A Vero SE 18	BXRC-35A4001-C-73-SE	3500	80	93	1170	4650	4185	34.1	39.9	117
Décor Class A Vero SE 18	BXRC-35A4001-D-73-SE	3500	80	93	1050	3478	3129	28.3	29.7	117
Décor Class A Vero SE 18	BXRC-40A4001-B-73-SE	4000	80	93	900	3826	3443	34.1	30.7	125
Décor Class A Vero SE 18	BXRC-40A4001-C-73-SE	4000	80	93	1170	4974	4477	34.1	39.9	125
Décor Class A Vero SE 18	BXRC-40A4001-D-73-SE	4000	80	93	1050	3720	3348	28.3	29.7	125
Décor Class A Vero SE 29	BXRC-30A10K1-B-73-SE	3000	80	93	1800	10088	9079	50.5	90.9	111
Décor Class A Vero SE 29	BXRC-30A10K1-C-73-SE	3000	80	93	1710	12778	11500	67.4	115.3	111
Décor Class A Vero SE 29	BXRC-30A10K1-D-73-SE	3000	80	93	2100	8500	7650	36.6	76.8	111
Décor Class A Vero SE 29	BXRC-35A10K1-B-73-SE	3500	80	93	1800	10845	9760	50.5	90.9	119
Décor Class A Vero SE 29	BXRC-35A10K1-C-73-SE	3500	80	93	1710	13736	12363	67.4	115.2	119
Décor Class A Vero SE 29	BXRC-35A10K1-D-73-SE	3500	80	93	2100	9137	8223	36.6	76.8	119
Décor Class A Vero SE 29	BXRC-40A10K1-B-73-SE	4000	80	93	1800	11601	10441	50.5	90.9	128
Décor Class A Vero SE 29	BXRC-40A10K1-C-73-SE	4000	80	93	1710	14694	13225	67.4	115.2	128
Décor Class A Vero SE 29	BXRC-40A10K1-D-73-SE	4000	80	93	2100	9775	8797	36.6	76.8	127

Notes for Table 3:

- Nominal CCT is defined by the Lighting Research Center's Class A definition. The center of the Class A color bin is on the corresponding isothermal line.
- To help ensure optimal fixture level performance, GAI is measured at the fixture level, on axis, at a case temperature of 70°C . GAI may vary depending on fixture design and performance.
- CRI Values are specified as typical.
- Drive current is referred to as nominal drive current.
- Typical performance values are provided as a reference only and are not a guarantee of performance.
- Bridgelux maintains a $\pm 7\%$ tolerance on flux measurements.
- Typical stabilized DC performance values are provided as reference only and are not a guarantee of performance.
- Typical performance is estimated based on operation under DC (direct current) with LED array mounted onto a heat sink with thermal interface material and the case temperature maintained at specified temperature. Based on Bridgelux test setup, values may vary depending on the thermal design of the luminaire and/or the exposed environment to which the product is subjected.
- Minimum flux values at elevated temperatures are provided for reference only and are not guaranteed by 100% production testing. Based on Bridgelux test setup, values may vary depending on the thermal design of the luminaire and/or the exposed environment to which the product is subjected.

Performance at Commonly Used Drive Currents

Vero SE LED arrays are tested to the specifications shown using the nominal drive currents in Table 1. Vero SE may also be driven at other drive currents dependent on specific application design requirements. The performance at any drive current can be derived from the current vs. voltage characteristics shown in Figure 1-12 and the flux vs. current characteristics shown in Figures 13-24. The performance at commonly used drive currents is summarized in Table 4.

Table 4: Product Performance at Commonly Used Drive Currents

Product	Part Number	GAI	CRI	Drive Current ¹ (mA)	Typical V _f T _c = 25°C (V)	Typical Power T _c = 25°C (W)	Typical Flux ² T _c = 25°C (lm)	Typical DC Flux ³ T _c = 85°C (lm)	Typical Efficacy T _c = 25°C (lm/W)
Décor Class A Vero SE 10	BXRC-30A1001-B-73-SE	80	93	135	33.3	4.5	562	506	125
				180	33.8	6.1	738	664	121
				270	35.0	9.5	1056	950	112
				405	36.4	14.8	1549	1394	105
Décor Class A Vero SE 10	BXRC-30A1001-C-73-SE	80	93	540	37.8	20.4	1984	1786	97
				180	33.3	6.0	748	673	125
				240	33.8	8.1	980	882	121
				360	35.0	12.6	1407	1267	112
Décor Class A Vero SE 10	BXRC-30A1001-D-73-SE	80	93	540	36.4	19.7	2049	1845	104
				720	37.7	27.1	2618	2356	96
				175	24.9	4.4	548	493	126
				233	25.4	5.9	719	647	122
Décor Class A Vero SE 10	BXRC-30A1001-D-73-SE	80	93	350	26.0	9.1	1026	924	113
				525	27.4	14.4	1511	1360	105
				700	28.4	19.9	1936	1742	97
				135	33.3	4.5	606	545	135
Décor Class A Vero SE 10	BXRC-35A1001-B-73-SE	80	93	180	33.8	6.1	795	715	130
				270	35.0	9.5	1137	1024	120
				405	36.4	14.8	1668	1502	113
				540	37.8	20.4	2137	1924	105
Décor Class A Vero SE 10	BXRC-35A1001-C-73-SE	80	93	180	33.3	6.0	806	726	135
				240	33.8	8.1	1056	951	130
				360	35.0	12.6	1516	1365	120
				540	36.4	19.7	2208	1987	112
Décor Class A Vero SE 10	BXRC-35A1001-C-73-SE	80	93	720	37.7	27.1	2820	2538	104
				175	24.9	4.4	591	532	135
				233	25.4	5.9	775	697	131
				350	26.0	9.1	1106	996	122
Décor Class A Vero SE 10	BXRC-35A1001-D-73-SE	80	93	525	27.4	14.4	1628	1465	113
				700	28.4	19.9	2086	1877	105

Notes for Table 4:

1. Alternate drive currents in Table 4 are provided for reference only and are not a guarantee of performance.
2. Bridgelux maintains a ± 7% tolerance on flux measurements.
3. Typical stabilized DC performance values are provided as reference only and not a guarantee of performance.

Performance at Commonly Used Drive Currents

Table 4: Product Performance at Commonly Used Drive Currents (Continued)

Product	Part Number	GAI	CRI	Drive Current ¹ (mA)	Typical V_f $T_c = 25^\circ\text{C}$ (V)	Typical Power $T_c = 25^\circ\text{C}$ (W)	Typical Flux ² $T_c = 25^\circ\text{C}$ (lm)	Typical DC Flux ³ $T_c = 85^\circ\text{C}$ (lm)	Typical Efficacy $T_c = 25^\circ\text{C}$ (lm/W)
Décor Class A Vero SE 10	BXRC-40A1001-B-73-SE	80	93	135	33.3	4.5	645	580	144
				180	33.8	6.1	846	761	139
				270	35.0	9.5	1210	1089	128
				405	36.4	14.8	1775	1598	120
				540	37.8	20.4	2274	2047	112
Décor Class A Vero SE 10	BXRC-40A1001-C-73-SE	80	93	180	33.3	6.0	858	772	143
				240	33.8	8.1	1124	1011	138
				360	35.0	12.6	1614	1452	128
				540	36.4	19.7	2350	2115	120
				720	37.7	27.1	3001	2701	111
Décor Class A Vero SE 10	BXRC-40A1001-D-73-SE	80	93	175	24.9	4.4	628	565	144
				233	25.4	5.9	824	741	139
				350	26.0	9.1	1176	1059	129
				525	27.4	14.4	1731	1558	120
				700	28.4	19.9	2218	1996	112
Décor Class A Vero SE 13	BXRC-30A2001-B-73-SE	80	93	113	32.3	3.7	500	450	137
				225	33.2	7.5	968	871	129
				450	35.0	15.8	1836	1652	117
				675	36.3	24.5	2653	2387	108
				900	37.5	33.7	3384	3045	100
Décor Class A Vero SE 13	BXRC-30A2001-C-73-SE	80	93	158	32.3	5.1	694	625	136
				315	33.2	10.5	1344	1210	128
				630	35.0	22.1	2570	2313	117
				945	36.4	34.4	3688	3319	107
				1260	37.8	47.6	4707	4236	99
Décor Class A Vero SE 13	BXRC-30A2001-D-73-SE	80	93	125	29.6	3.7	495	445	134
				250	30.3	7.6	959	863	126
				500	31.8	15.9	1869	1682	118
				750	33.2	24.9	2641	2377	106
				1000	34.4	34.4	3377	3039	98
Décor Class A Vero SE 13	BXRC-35A2001-B-73-SE	80	93	113	32.3	3.7	538	484	147
				225	33.2	7.5	1040	936	139
				450	35.0	15.8	1974	1776	125
				675	36.3	24.5	2852	2567	117
				900	37.5	33.7	3638	3275	108
Décor Class A Vero SE 13	BXRC-35A2001-C-73-SE	80	93	158	32.3	5.1	746	672	146
				315	33.2	10.5	1445	1301	138
				630	35.0	22.1	2763	2486	125
				945	36.4	34.4	3965	3569	115
				1260	37.8	47.6	5061	4555	106
Décor Class A Vero SE 13	BXRC-35A2001-D-73-SE	80	93	125	29.6	3.7	532	479	144
				250	30.3	7.6	1031	928	136
				500	31.8	15.9	2009	1808	126
				750	33.2	24.9	2839	2555	114
				1000	34.4	34.4	3630	3267	105

Notes for Table 4:

1. Alternate drive currents in Table 4 are provided for reference only and are not a guarantee of performance.
2. Bridgelux maintains a $\pm 7\%$ tolerance on flux measurements.
3. Typical stabilized DC performance values are provided as reference only and not a guarantee of performance.

Performance at Commonly Used Drive Currents

Table 4: Product Performance at Commonly Used Drive Currents (Continued)

Product	Part Number	GAI	CRI	Drive Current ¹ (mA)	Typical V _f T _c = 25°C (V)	Typical Power T _c = 25°C (W)	Typical Flux ² T _c = 25°C (lm)	Typical DC Flux ³ T _c = 85°C (lm)	Typical Efficacy T _c = 25°C (lm/W)
Décor Class A Vero SE 13	BXRC-40A2001-B-73-SE	80	93	113	32.3	3.7	575	517	157
				225	33.2	7.5	1113	1001	149
				450	35.0	15.8	2111	1900	134
				675	36.3	24.5	3051	2746	125
				900	37.5	33.7	3891	3502	115
Décor Class A Vero SE 13	BXRC-40A2001-C-73-SE	80	93	158	32.3	5.1	798	718	156
				315	33.2	10.5	1545	1391	148
				630	35.0	22.1	2955	2659	134
				945	36.4	34.4	4241	3817	123
				1260	37.8	47.6	5413	4871	114
Décor Class A Vero SE 13	BXRC-40A2001-D-73-SE	80	93	125	29.6	3.7	569	512	154
				250	30.3	7.6	1103	993	145
				500	31.8	15.9	2150	1935	135
				750	33.2	24.9	3038	2735	122
				1000	34.4	34.4	3885	3497	113
Décor Class A Vero SE 18	BXRC-30A4001-B-73-SE	80	93	450	33.3	15.0	1985	1786	132
				600	33.9	20.4	2603	2343	128
				900	35.0	31.5	3696	3327	117
				1350	36.7	49.5	5498	4948	111
				1800	38.0	68.4	7074	6367	103
Décor Class A Vero SE 18	BXRC-30A4001-C-73-SE	80	93	585	33.4	19.5	2511	2260	129
				780	34.0	26.5	3291	2962	124
				1170	35.0	41.0	4807	4326	117
				1755	36.8	64.5	6915	6223	107
				2340	38.1	89.3	8870	7983	99
Décor Class A Vero SE 18	BXRC-30A4001-D-73-SE	80	93	525	27.7	14.6	1914	1723	131
				700	28.2	19.8	2489	2240	126
				1050	29.0	30.5	3594	3234	118
				1575	30.4	47.9	5133	4620	107
				2100	31.5	66.2	6534	5881	99
Décor Class A Vero SE 18	BXRC-35A4001-B-73-SE	80	93	450	33.3	15.0	2133	1920	142
				600	33.9	20.4	2799	2519	137
				900	35.0	31.5	3974	3576	126
				1350	36.7	49.5	5910	5319	119
				1800	38.0	68.4	7605	6845	111
Décor Class A Vero SE 18	BXRC-35A4001-C-73-SE	80	93	585	33.4	19.5	2700	2430	138
				780	34.0	26.5	3538	3184	133
				1170	35.0	41.0	5167	4650	126
				1755	36.8	64.5	7433	6690	115
				2340	38.1	89.3	9535	8581	107
Décor Class A Vero SE 18	BXRC-35A4001-D-73-SE	80	93	525	27.7	14.6	2058	1853	141
				700	28.2	19.8	2677	2409	135
				1050	29.0	30.5	3864	3478	127
				1575	30.4	47.9	5519	4967	115
				2100	31.5	66.2	7026	6323	106

Notes for Table 4:

1. Alternate drive currents in Table 4 are provided for reference only and are not a guarantee of performance.
2. Bridgelux maintains a ± 7% tolerance on flux measurements.
3. Typical stabilized DC performance values are provided as reference only and not a guarantee of performance.

Performance at Commonly Used Drive Currents

Table 4: Product Performance at Commonly Used Drive Currents (Continued)

Product	Part Number	GAI	CRI	Drive Current ¹ (mA)	Typical V_f $T_c = 25^\circ\text{C}$ (V)	Typical Power $T_c = 25^\circ\text{C}$ (W)	Typical Flux ² $T_c = 25^\circ\text{C}$ (lm)	Typical DC Flux ³ $T_c = 85^\circ\text{C}$ (lm)	Typical Efficacy $T_c = 25^\circ\text{C}$ (lm/W)
Décor Class A Vero SE 18	BXRC-40A4001-B-73-SE	80	93	450	33.3	15.0	2282	2054	152
				600	33.9	20.4	2994	2695	147
				900	35.0	31.5	4251	3826	135
				1350	36.7	49.5	6323	5690	128
Décor Class A Vero SE 18	BXRC-40A4001-C-73-SE	80	93	1800	38.0	68.4	8136	7322	119
				585	33.4	19.5	2888	2599	148
				780	34.0	26.5	3784	3406	143
				1170	35.0	41.0	5527	4974	135
Décor Class A Vero SE 18	BXRC-40A4001-D-73-SE	80	93	1755	36.8	64.5	7951	7156	123
				2340	38.1	89.3	10199	9180	114
				525	27.7	14.6	2202	1982	151
				700	28.2	19.8	2863	2577	145
Décor Class A Vero SE 18	BXRC-40A4001-D-73-SE	80	93	1050	29.0	30.5	4134	3720	136
				1575	30.4	47.9	5904	5314	123
				2100	31.5	66.2	7516	6764	114
				900	49.6	44.7	5873	5286	131
Décor Class A Vero SE 29	BXRC-30A10K1-B-73-SE	80	93	1200	50.5	60.6	7750	6975	128
				1800	52.0	93.6	11209	10088	120
				2700	54.1	146.1	16526	14874	113
				3600	55.8	201.0	21308	19177	106
Décor Class A Vero SE 29	BXRC-30A10K1-C-73-SE	80	93	855	66.2	56.6	8065	7259	143
				1140	67.3	76.7	10251	9226	134
				1710	69.4	118.7	14197	12778	120
				2565	72.1	185.0	20141	18127	109
Décor Class A Vero SE 29	BXRC-30A10K1-C-73-SE	80	93	3420	74.4	254.6	25245	22720	99
				1050	35.4	37.2	5195	4675	140
				1400	36.2	50.6	6686	6017	132
				2100	37.6	79.0	9444	8500	120
Décor Class A Vero SE 29	BXRC-30A10K1-D-73-SE	80	93	3150	39.5	124.4	13445	12101	108
				4200	41.2	172.9	16946	15251	98
				900	49.6	44.7	6314	5683	141
				1200	50.5	60.6	8331	7498	138
Décor Class A Vero SE 29	BXRC-35A10K1-B-73-SE	80	93	1800	52.0	93.6	12050	10845	129
				2700	54.1	146.1	17766	15990	122
				3600	55.8	201.0	22907	20616	114
				855	66.2	56.6	8670	7803	153
Décor Class A Vero 29	BXRC-35A10K1-C-73-SE	80	93	1140	67.3	76.7	11020	9918	144
				1710	69.4	118.7	15263	13736	129
				2565	72.1	185.0	21652	19487	117
				3420	74.4	254.6	27139	24425	107
Décor Class A Vero SE 29	BXRC-35A10K1-D-73-SE	80	93	1050	35.4	37.2	5584	5026	150
				1400	36.2	50.6	7187	6468	142
				2100	37.6	79.0	10153	9137	129
				3150	39.5	124.4	14454	13008	116
Décor Class A Vero SE 29	BXRC-35A10K1-D-73-SE	80	93	4200	41.2	172.9	18217	16395	105

Notes for Table 4:

1. Alternate drive currents in Table 4 are provided for reference only and are not a guarantee of performance.
2. Bridgelux maintains a $\pm 7\%$ tolerance on flux measurements.
3. Typical stabilized DC performance values are provided as reference only and not a guarantee of performance.

Performance at Commonly Used Drive Currents

Table 4: Product Performance at Commonly Used Drive Currents (Continued)

Product	Part Number	GAI	CRI	Drive Current ¹ (mA)	Typical V_f $T_c = 25^\circ\text{C}$ (V)	Typical Power $T_c = 25^\circ\text{C}$ (W)	Typical Flux ² $T_c = 25^\circ\text{C}$ (lm)	Typical DC Flux ³ $T_c = 85^\circ\text{C}$ (lm)	Typical Efficacy $T_c = 25^\circ\text{C}$ (lm/W)
Décor Class A Vero SE 29	BXRC-40A10K1-B-73-SE	80	93	900	49.6	44.7	6754	6079	151
				1200	50.5	60.6	8912	8021	147
				1800	52.0	93.6	12890	11601	138
				2700	54.1	146.1	19005	17104	130
				3600	55.8	201.0	24503	22053	122
Décor Class A Vero SE 29	BXRC-40A10K1-C-73-SE	80	93	855	66.2	56.6	9275	8347	164
				1140	67.3	76.7	11788	10610	154
				1710	69.4	118.7	16327	14694	138
				2565	72.1	185.0	23162	20846	125
				3420	74.4	254.6	29031	26128	114
Décor Class A Vero SE 29	BXRC-40A10K1-D-73-SE	80	93	1050	35.4	37.2	5974	5377	161
				1400	36.2	50.6	7688	6920	152
				2100	37.6	79.0	10861	9775	138
				3150	39.5	124.4	15462	13916	124
				4200	41.2	172.9	19487	17539	113

Notes for Table 4:

1. Alternate drive currents in Table 4 are provided for reference only and are not a guarantee of performance.
2. Bridgelux maintains a $\pm 7\%$ tolerance on flux measurements.
3. Typical stabilized DC performance values are provided as reference only and not a guarantee of performance.

Electrical Characteristics

Table 5: Electrical Characteristics

Part Number	Nominal Drive Current ¹ (mA)	Forward Voltage Pulsed, T _c = 25°C (V) ^{1,2,3,8}			Typical Coefficient of Forward Voltage ⁴ ΔV _f /ΔT _c (mV/°C)	Typical Thermal Resistance Junction to Case ^{5,6} R _{j-c} (C/W)	Driver Selection Voltages ⁷ (V)	
		Minimum	Typical	Maximum			V _f Min. Hot T _c = 105°C (V)	V _f Max. Cold ⁴ T _c = -40°C (V)
BXRC-xxx100x-B-7x-SE	270	32.4	35.0	37.6	-16.1	0.49	31.1	38.7
	540	34.9	37.8	40.6	-16.1	0.57	33.6	41.6
BXRC-xxx100x-C-7x-SE	360	32.4	35.0	37.6	-16.1	0.37	31.1	38.7
	720	34.9	37.7	40.5	-16.1	0.43	33.6	41.6
BXRC-xxx100x-D-7x-SE	350	24.1	26.0	28.0	-11.8	0.49	23.1	28.7
	700	26.3	28.4	30.5	-11.8	0.57	25.3	31.3
BXRC-xxx200x-B-7x-SE	450	32.4	35.0	37.6	-14.3	0.28	31.2	38.6
	900	34.7	37.5	40.3	-14.3	0.35	33.5	41.2
BXRC-xxx200x-C-7x-SE	630	32.4	35.0	37.6	-14.3	0.20	31.2	38.6
	1260	34.9	37.8	40.6	-14.3	0.24	33.8	41.5
BXRC-xxx200x-D-7x-SE	500	29.4	31.8	34.2	-13.3	0.34	28.4	35.0
	1000	31.8	34.4	37.0	-13.3	0.41	30.8	37.9
BXRC-xxx400x-B-7x-SE	900	32.4	35.0	37.6	-14.9	0.15	31.2	38.6
	1800	35.2	38.0	40.9	-14.9	0.19	34.0	41.8
BXRC-xxx400x-C-7x-SE	1170	32.4	35.0	37.6	-14.9	0.11	31.2	38.6
	2340	35.3	38.1	41.0	-14.9	0.13	34.1	42.0
BXRC-xxx400x-D-7x-SE	1050	26.8	29.0	31.2	-12.2	0.16	25.8	32.0
	2100	29.2	31.5	33.9	-12.2	0.19	28.2	34.7
BXRC-xxx10Kx-B-7x-SE	1800	48.1	52.0	55.9	-24.9	0.06	46.1	57.5
	3600	51.7	55.8	60.0	-24.9	0.07	49.7	61.6
BXRC-xxx10Kx-C-7x-SE	1710	64.2	69.4	74.6	-33.2	0.04	61.5	76.8
	3420	68.8	74.4	80.0	-33.2	0.05	66.2	82.2
BXRC-xxx10Kx-D-7x-SE	2100	34.8	37.6	40.4	-17.4	0.06	33.4	41.6
	4200	38.1	41.2	44.3	-17.4	0.07	36.7	45.4

Notes for Table 5:

- Parts are tested in pulsed conditions, T_c = 25°C. Pulse width is 10ms.
- Voltage minimum and maximum are provided for reference only and are not a guarantee of performance.
- Bridgelux maintains a tester tolerance of ± 0.10V on forward voltage measurements.
- Typical coefficient of forward voltage tolerance is ± 0.1mV for nominal current.
- Thermal resistance values are based from test data of a 3000K 80 CRI product.
- Thermal resistance value was calculated using total electrical input power; optical power was not subtracted from input power. The thermal interface material used during testing is not included in the thermal resistance value.
- V_f min hot and max cold values are provided as reference only and are not guaranteed by test. These values are provided to aid in driver design and selection over the operating range of the product.
- This product has been designed and manufactured per IEC 62031:2014. This product has passed dielectric withstand voltage testing at 1160 V. The working voltage designated for the insulation is 80V d.c. The maximum allowable voltage across the array must be determined in the end product application.

Eye Safety

Table 5: Eye Safety Classifications

Part Number	Drive Current ³ (mA)	CCT ^{1,3}	
		2700K/3000K	4000K ²
BXRC-xxx100x-B-7x-SE	270	RG1	RG1
	405	RG1	RG1
	540	RG1	RG1
BXRC-xxx100x-C-7x-SE	360	RG1	RG1
	540	RG1	RG1
	720	RG1	RG2
BXRC-xxx100x-D-7x-SE	350	RG1	RG1
	525	RG1	RG1
	700	RG1	RG1
BXRC-xxx200x-B-7x-SE	450	RG1	RG1
	675	RG1	RG1
	900	RG1	RG1
BXRC-xxx200x-C-7x-SE	630	RG1	RG1
	945	RG1	RG1
	1260	RG1	RG2
BXRC-xxx200x-D-7x-SE	500	RG1	RG1
	750	RG1	RG1
	1000	RG1	RG1
BXRC-xxx400x-B-7x-SE	900	RG1	RG1
	1350	RG1	RG1
	1800	RG1	RG1
BXRC-xxx400x-C-7x-SE	1170	RG1	RG1
	1755	RG1	RG1
	2340	RG1	RG1
BXRC-xxx400x-D-7x-SE	1050	RG1	RG1
	1575	RG1	RG1
	2100	RG1	RG1
BXRC-xxx10Kx-B-7x-SE	1800	RG1	RG1
	2700	RG1	RG1
	3600	RG1	RG1
BXRC-xxx10Kx-C-7x-SE	1710	RG1	RG2
	2565	RG1	RG2
	3420	RG1	RG2
BXRC-xxx10Kx-D-7x-SE	2100	RG1	RG1
	3150	RG1	RG1
	4200	RG1	RG1

Notes for Table 5:

1. Parts are tested in pulsed conditions, $T_c = 25^\circ\text{C}$. Pulse width is 10ms.

2. For products classified as RG2 at 4000K, $E_{\text{Irr}} = 1847.5 \text{ lx}$.

3. Please contact your Bridgelux sales representative for E_{Irr} values at specific drive currents and CCTs not listed.

Absolute Maximum Ratings

Table 6: Maximum Ratings

Parameter	Maximum Rating		
LED Junction Temperature	125°C		
Storage Temperature	-40°C to +105°C		
Operating Case Temperature ¹	105°C		
	BXRC-xxx100x-B-7x-SE	BXRC-xxx100x-C-7x-SE	BXRC-xxx100x-D-7x-SE
Maximum Drive Current ²	540mA	720mA	700mA
Maximum Peak Pulsed Drive Current ³	770mA	1030mA	1000mA
Maximum Reverse Voltage ⁴	-60V	-60V	-45V

	BXRC-xxx200x-B-7x-SE	BXRC-xxx200x-C-7x-SE	BXRC-xxx200x-D-7x-SE
Maximum Drive Current ²	900mA	1260mA	1000mA
Maximum Peak Pulsed Drive Current ³	1290mA	1800mA	1430mA
Maximum Reverse Voltage ⁴	-60V	-60V	-55V

	BXRC-xxx400x-B-7x-SE	BXRC-xxx400x-C-7x-SE	BXRC-xxx400x-D-7x-SE
Maximum Drive Current ²	1800mA	2340mA	2100mA
Maximum Peak Pulsed Drive Current ³	2570mA	3340mA	3000mA
Maximum Reverse Voltage ⁴	-60V	-60V	-50V

	BXRC-xxx10Kx-B-7x-SE	BXRC-xxx10Kx-C-7x-SE	BXRC-xxx10Kx-D-7x-SE
Maximum Drive Current ²	3600mA	3420mA	4200mA
Maximum Peak Pulsed Drive Current ³	5140mA	4890mA	6000mA
Maximum Reverse Voltage ⁴	-90V	-120V	-65V

Notes for Table 6:

1. For IEC 62717 requirement, please contact Bridgelux Sales Support.
2. Arrays may be driven at higher currents however lumen maintenance may be reduced.
3. Bridgelux recommends a maximum duty cycle of 10% and pulse width of 20ms when operating LED Arrays at the maximum peak pulsed current specified. Maximum peak pulsed current indicate values where the LED array can be driven without catastrophic failures.
4. Light emitting diodes are not designed to be driven in reverse voltage and will not produce light under this condition. Maximum rating provided for reference only.

Performance Curves

Figure 1: Vero SE 10B Drive Current vs. Forward Voltage ($T_j=T_c=25^\circ\text{C}$)

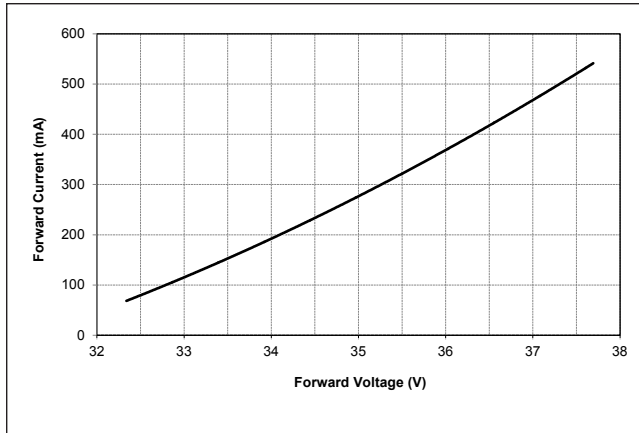

Figure 2: Vero SE 10C Drive Current vs. Forward Voltage ($T_j=T_c=25^\circ\text{C}$)

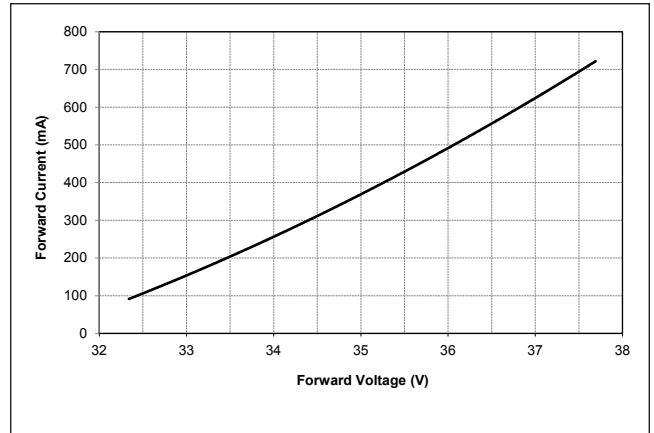

Figure 3: Vero SE 10D Drive Current vs. Forward Voltage ($T_j=T_c=25^\circ\text{C}$)

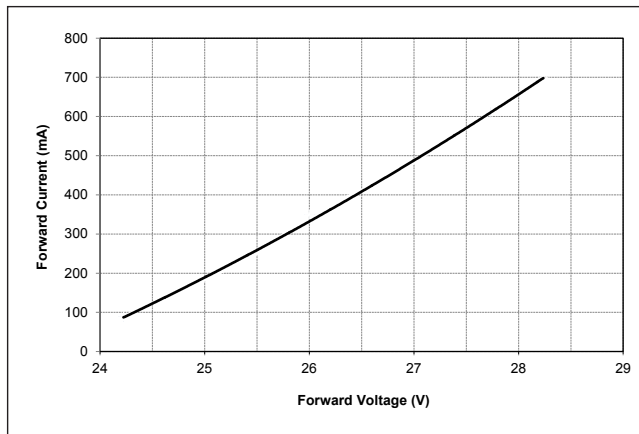

Figure 4: Vero SE 13B Drive Current vs. Forward Voltage ($T_j=T_c=25^\circ\text{C}$)

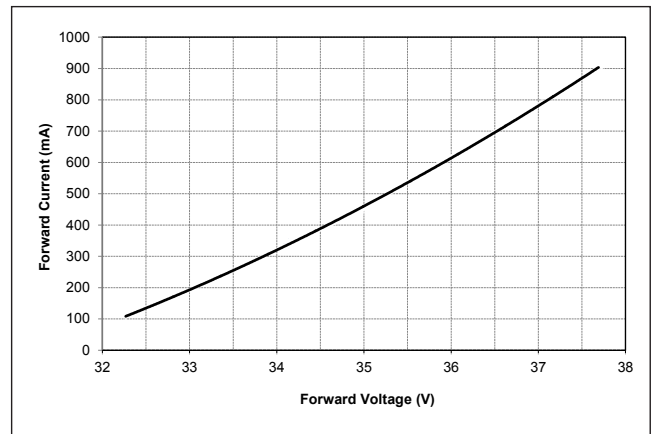

Figure 5: Vero SE 13C Drive Current vs. Forward Voltage ($T_j=T_c=25^\circ\text{C}$)

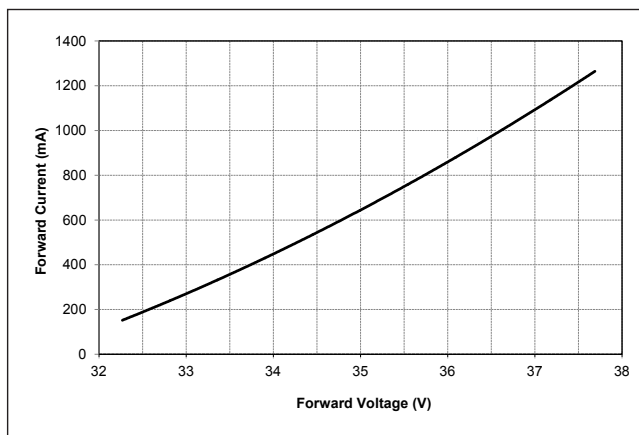
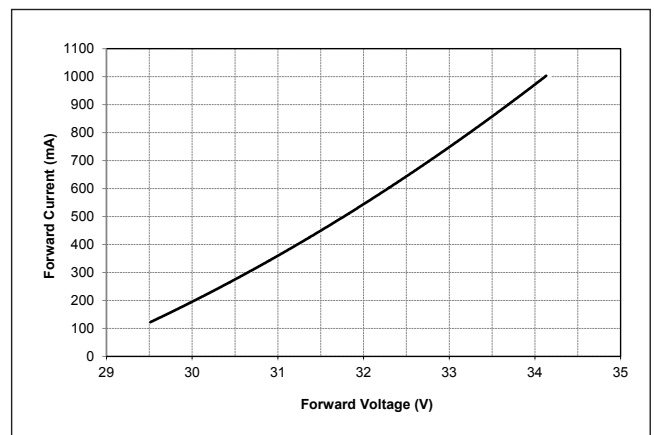

Figure 6: Vero SE 13D Drive Current vs. Forward Voltage ($T_j=T_c=25^\circ\text{C}$)



Performance Curves

Figure 7: Vero SE 18B Drive Current vs. Forward Voltage ($T_j=T_c=25^\circ\text{C}$)

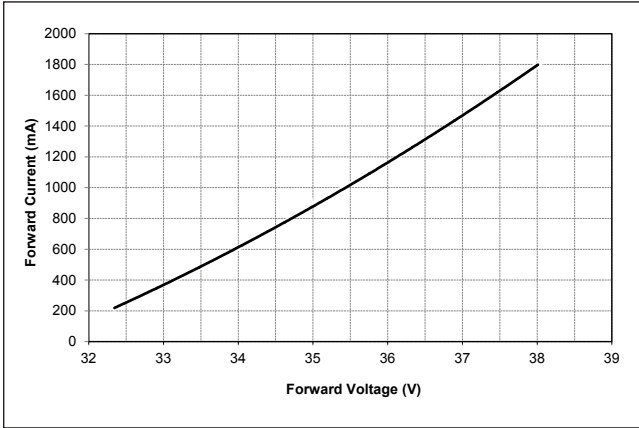

Figure 8: Vero SE 18C Drive Current vs. Forward Voltage ($T_j=T_c=25^\circ\text{C}$)

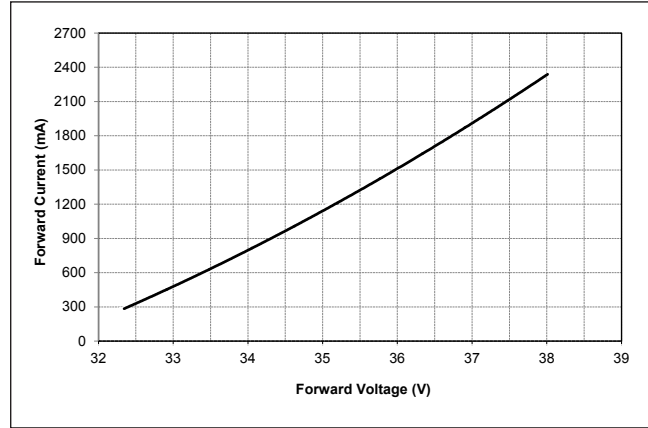

Figure 9: Vero SE 18D Drive Current vs. Forward Voltage ($T_j=T_c=25^\circ\text{C}$)

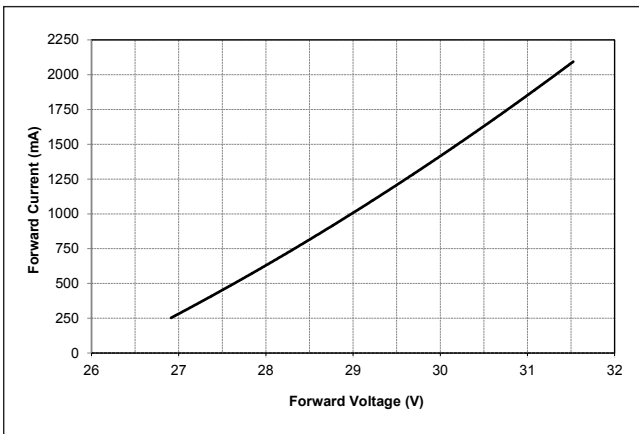

Figure 10: Vero SE 29B Drive Current vs. Forward Voltage ($T_j=T_c=25^\circ\text{C}$)

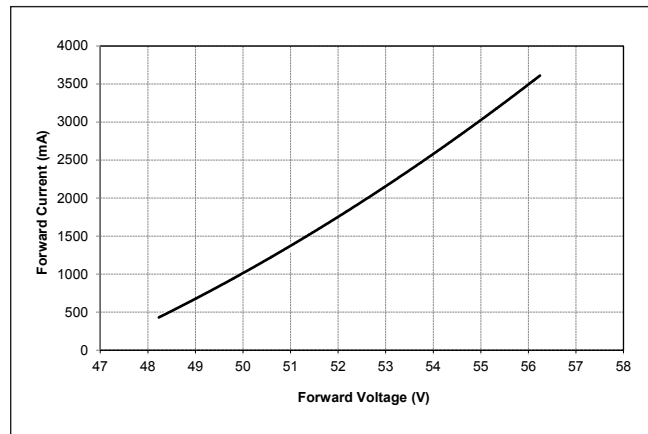

Figure 11: Vero SE 29C Drive Current vs. Forward Voltage ($T_j=T_c=25^\circ\text{C}$)

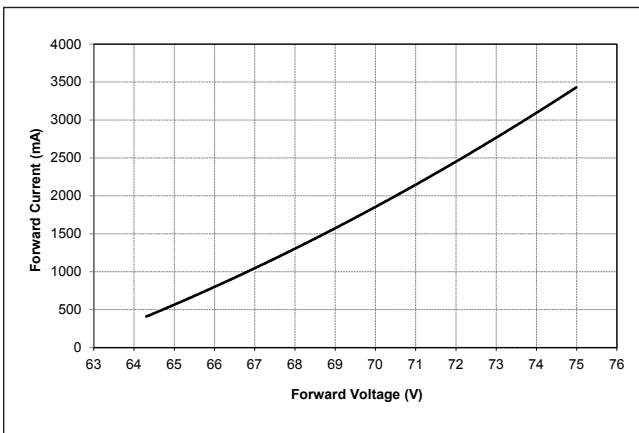
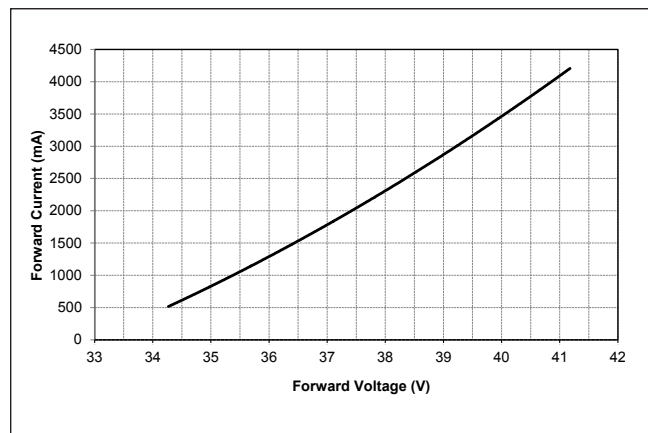

Figure 12: Vero SE 29D Drive Current vs. Forward Voltage ($T_j=T_c=25^\circ\text{C}$)



Performance Curves

Figure 13: Vero SE 10B Typical Relative Luminous Flux vs. Drive Current

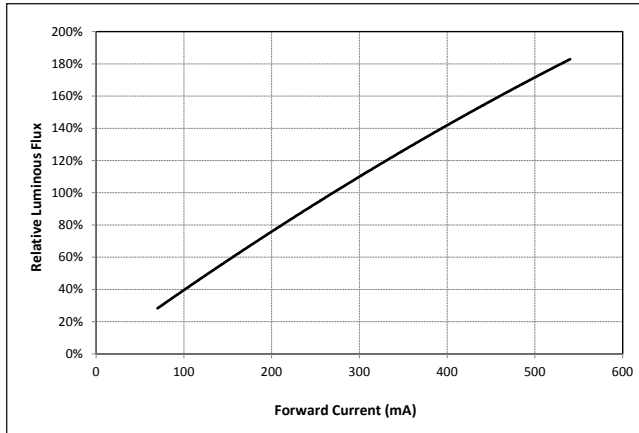

Figure 14: Vero SE 10C Typical Relative Luminous Flux vs. Drive Current

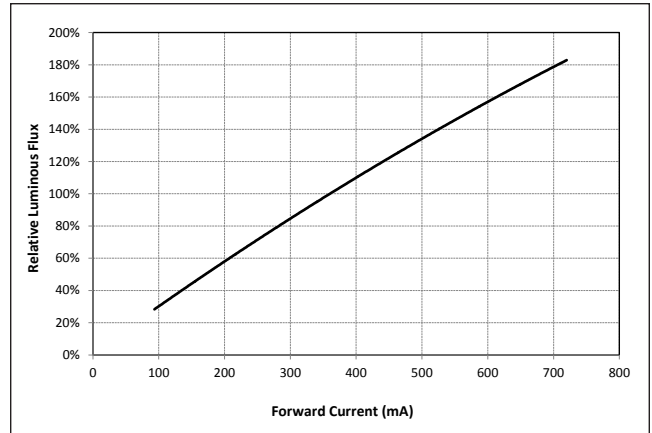

Figure 15: Vero SE 10D Typical Relative Luminous Flux vs. Drive Current

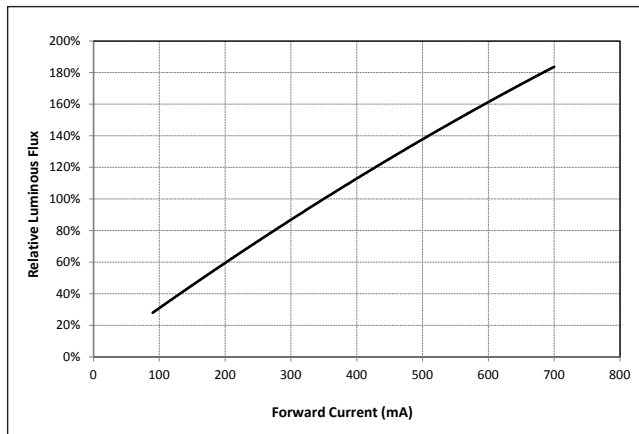

Figure 16: Vero SE 13B Typical Relative Luminous Flux vs. Drive Current

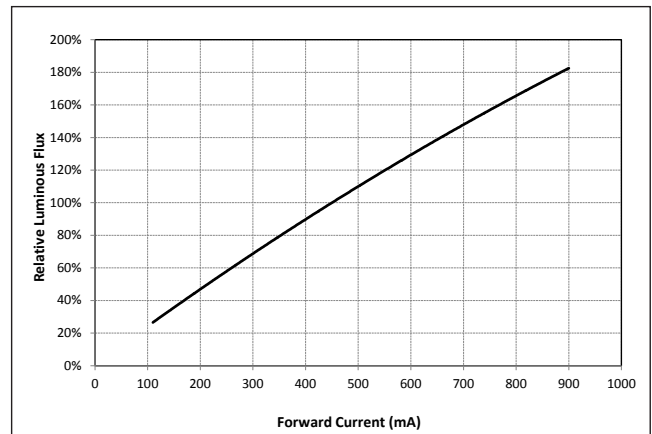

Figure 17: Vero SE 13C Typical Relative Luminous Flux vs. Drive Current

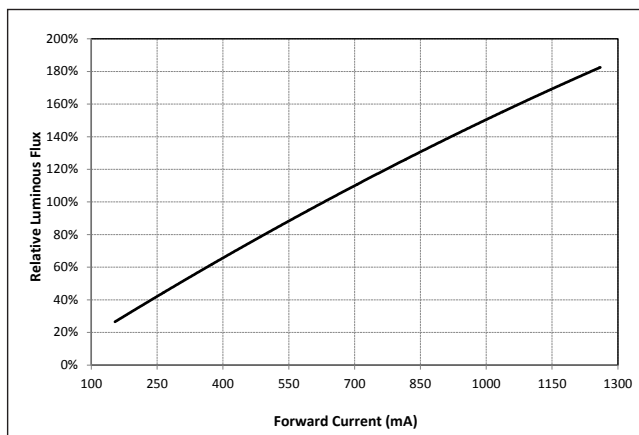
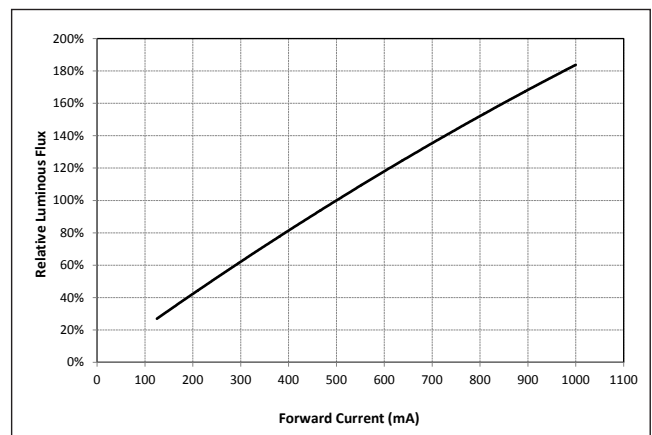

Figure 18: Vero SE 13D Typical Relative Luminous Flux vs. Drive Current



Performance Curves

Figure 19: Vero SE 18B Typical Relative Luminous Flux vs. Drive Current

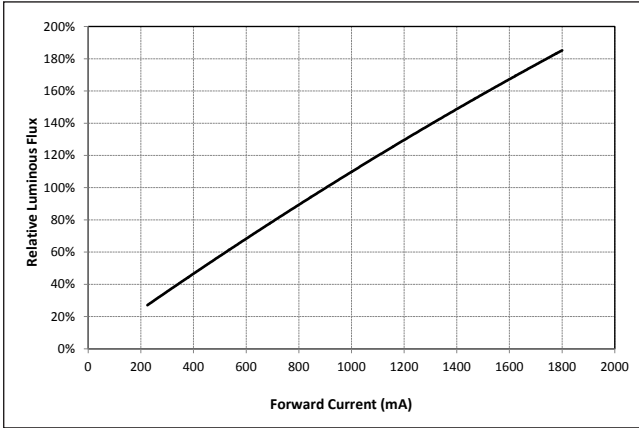

Figure 20: Vero SE 18C Typical Relative Luminous Flux vs. Drive Current

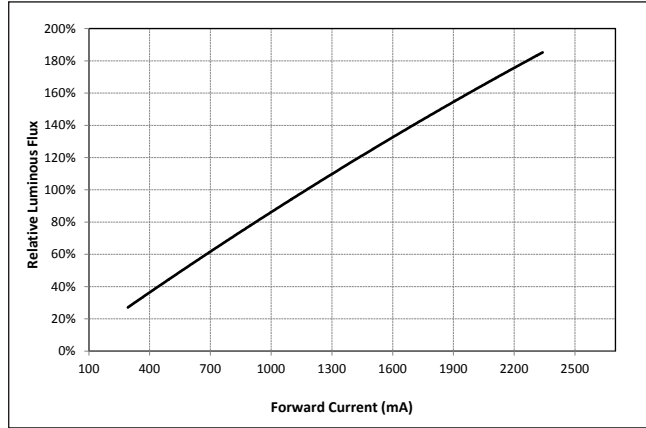

Figure 21: Vero SE 18D Typical Relative Luminous Flux vs. Drive Current

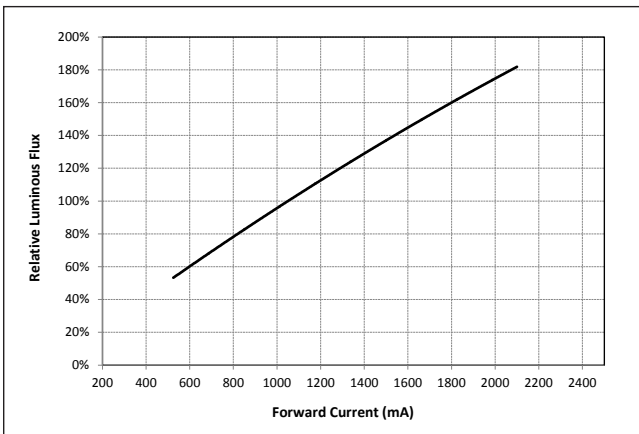

Figure 22: Vero SE 29B Typical Relative Luminous Flux vs. Drive Current

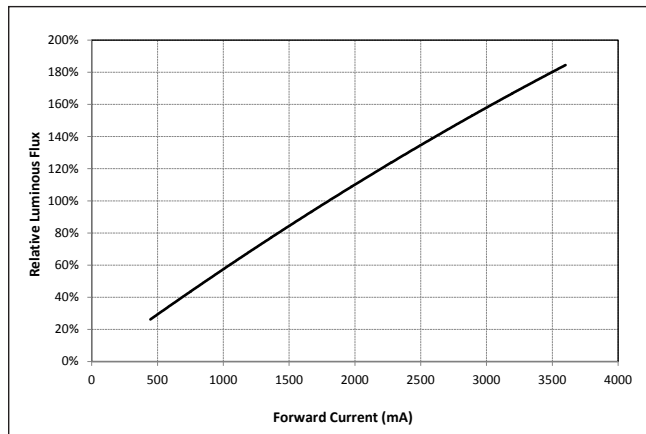

Figure 23: Vero SE 29C Typical Relative Luminous Flux vs. Drive Current

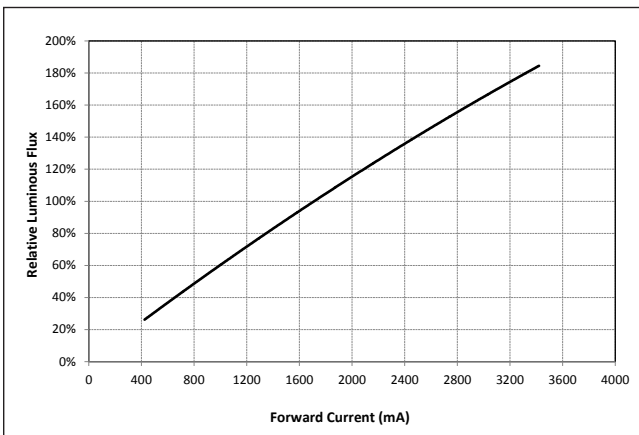
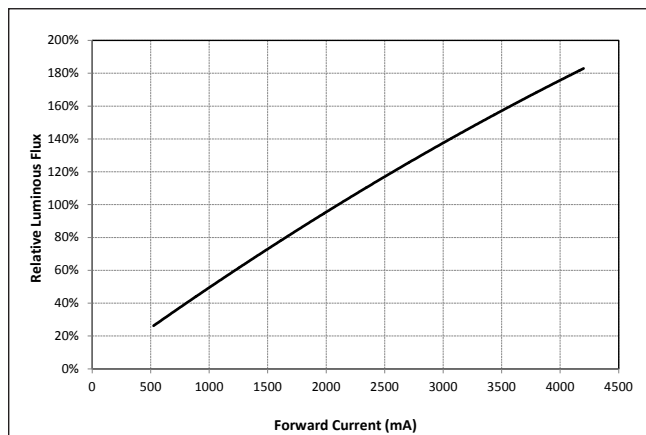

Figure 24: Vero SE 29C Typical Relative Luminous Flux vs. Drive Current



Performance Curves

Figure 25: Vero SE 10 Typical DC Flux vs. Case Temperature¹

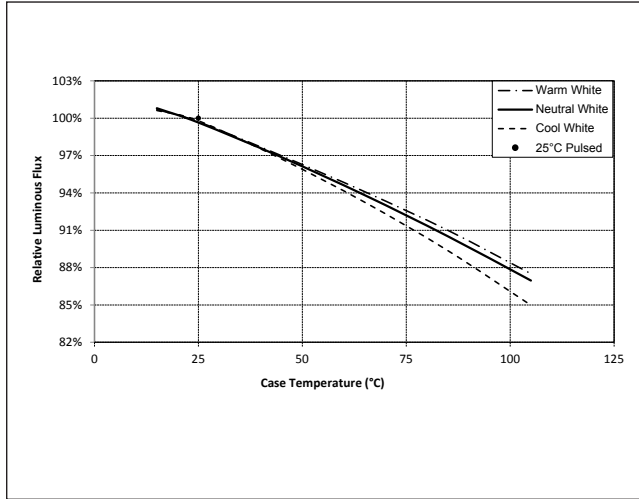

Figure 26: Vero SE 13 Typical DC Flux vs. Case Temperature¹

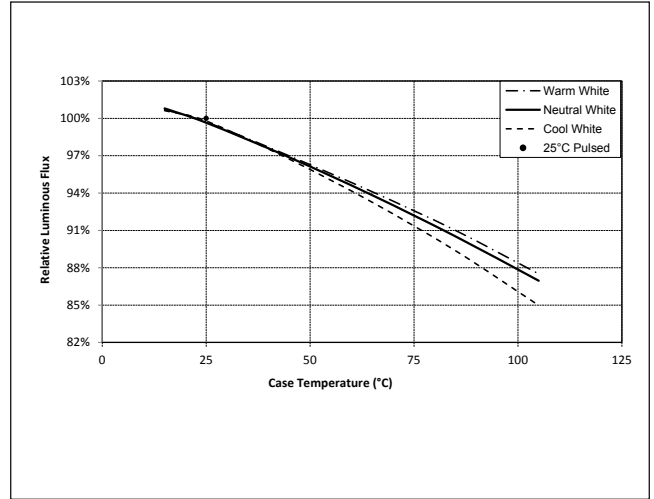

Figure 27: Vero SE 18 Typical DC Flux vs. Case Temperature¹

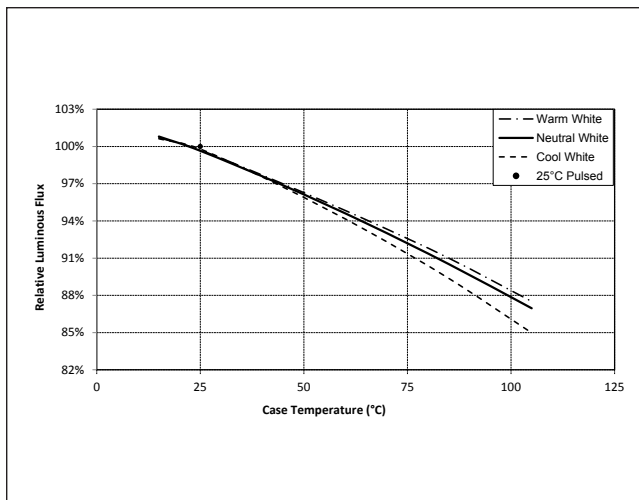
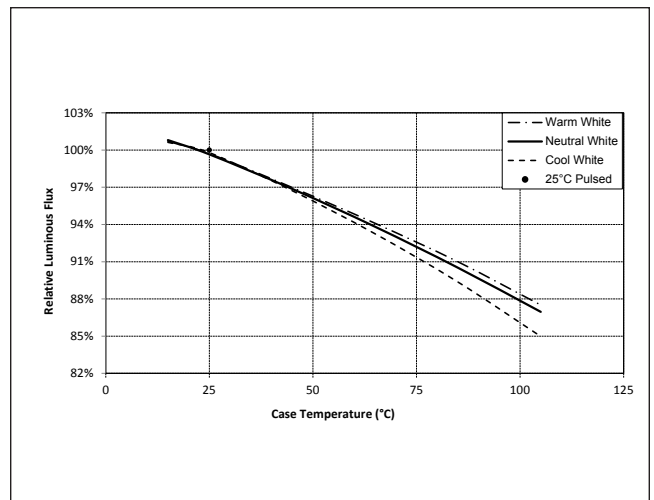

Figure 28: Vero SE 29 Typical DC Flux vs. Case Temperature¹



Note for Figures 25-28:

1. Flux measurements taken under DC conditions.
2. Characteristics shown for warm white based on 3000K and 80 CRI.
3. Characteristics shown for neutral white based on 4000K and 80 CRI.
4. Characteristics shown for cool white based on 5000K and 70 CRI.
5. For other color SKUs, the shift in color will vary. Please contact your Bridgelux Sales Representative for more information.

Performance Curves

Figure 29: 3000K Class A Color Shift vs. Case Temperature¹

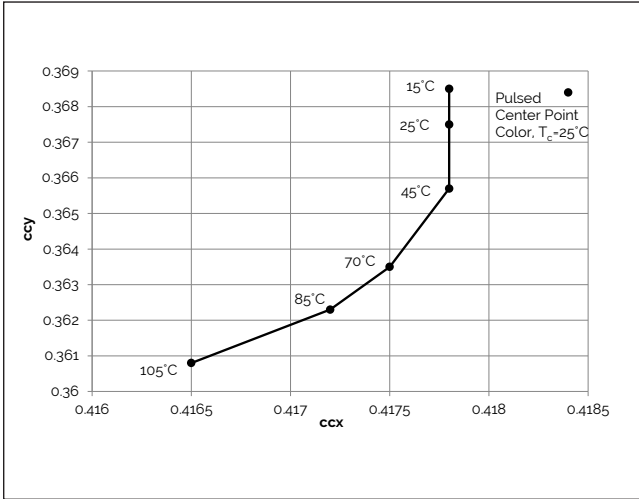

Figure 30: 3500K Class A Color Shift vs. Case Temperature¹

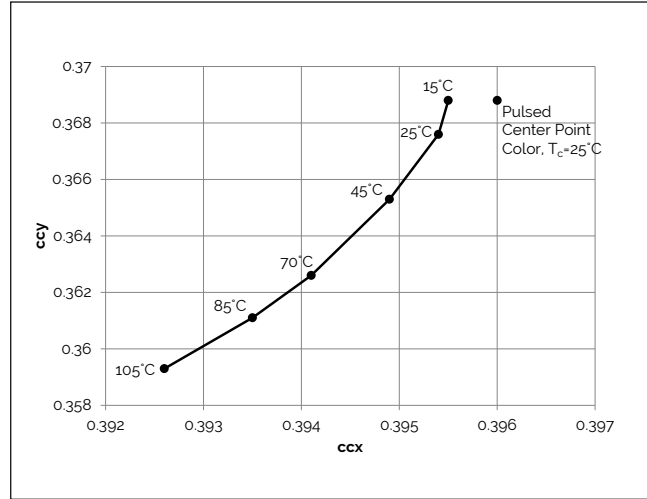
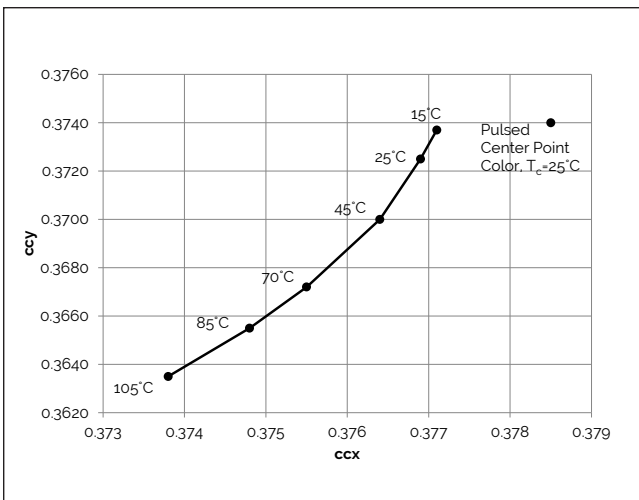

Figure 31: 4000K Class A Color Shift vs. Case Temperature¹



Note for Figures 29-31:

1. Measurements made under DC test conditions at the nominal drive current.
2. Typical color shift is shown with a tolerance of ± 0.002 .

Typical Radiation Pattern

Figure 32: Typical Spatial Radiation Pattern

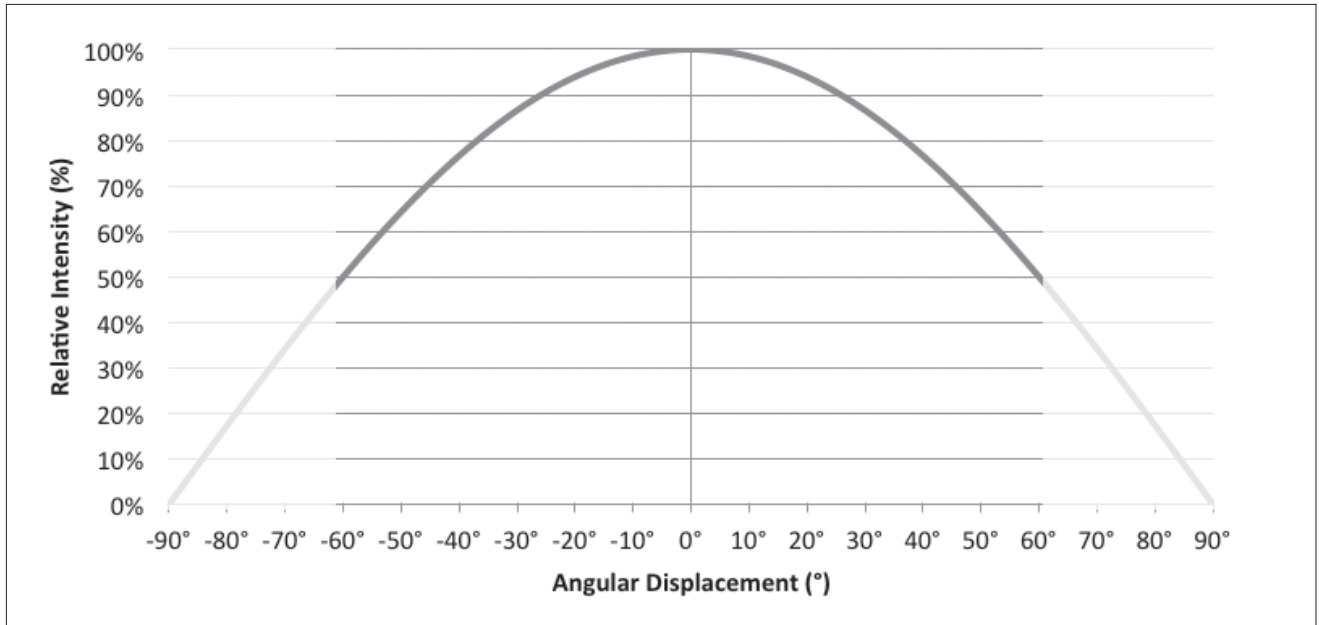

Notes for Figure 32:

1. Typical viewing angle is 120°.
2. The viewing angle is defined as the off axis angle from the centerline where I_v is $\frac{1}{2}$ of the peak value.

Figure 33: Typical Polar Radiation Pattern

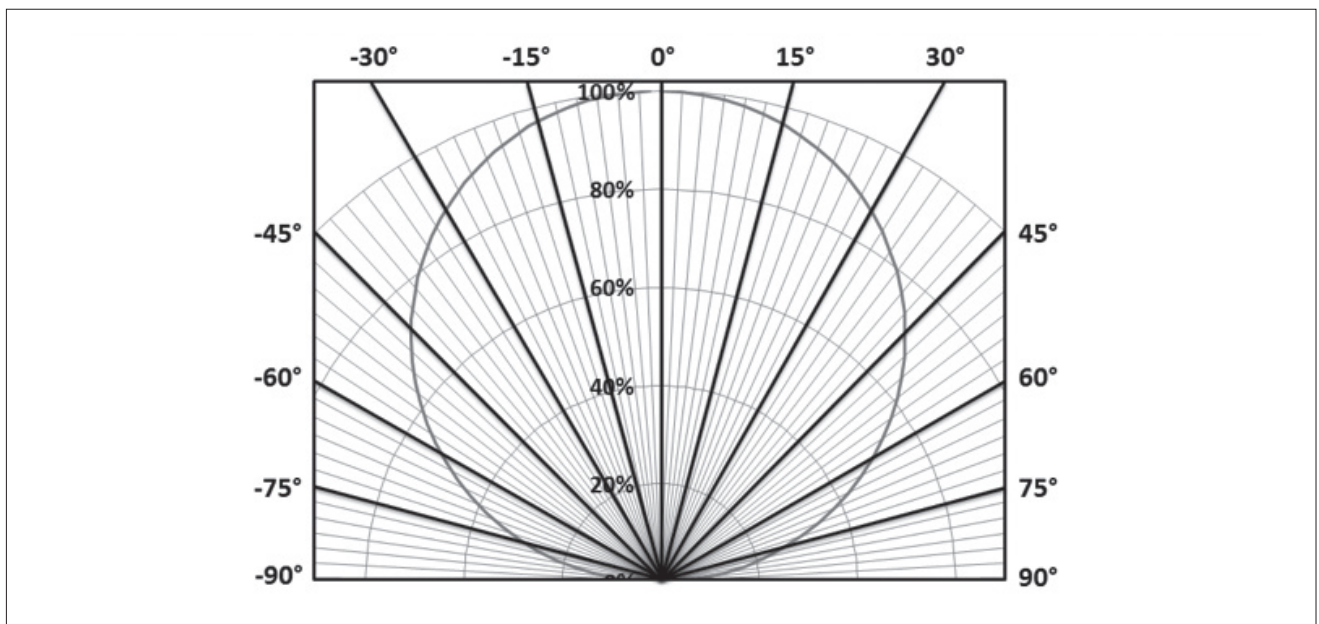

Mechanical Dimensions

Figure 34: Drawing for Vero SE 10 LED Array

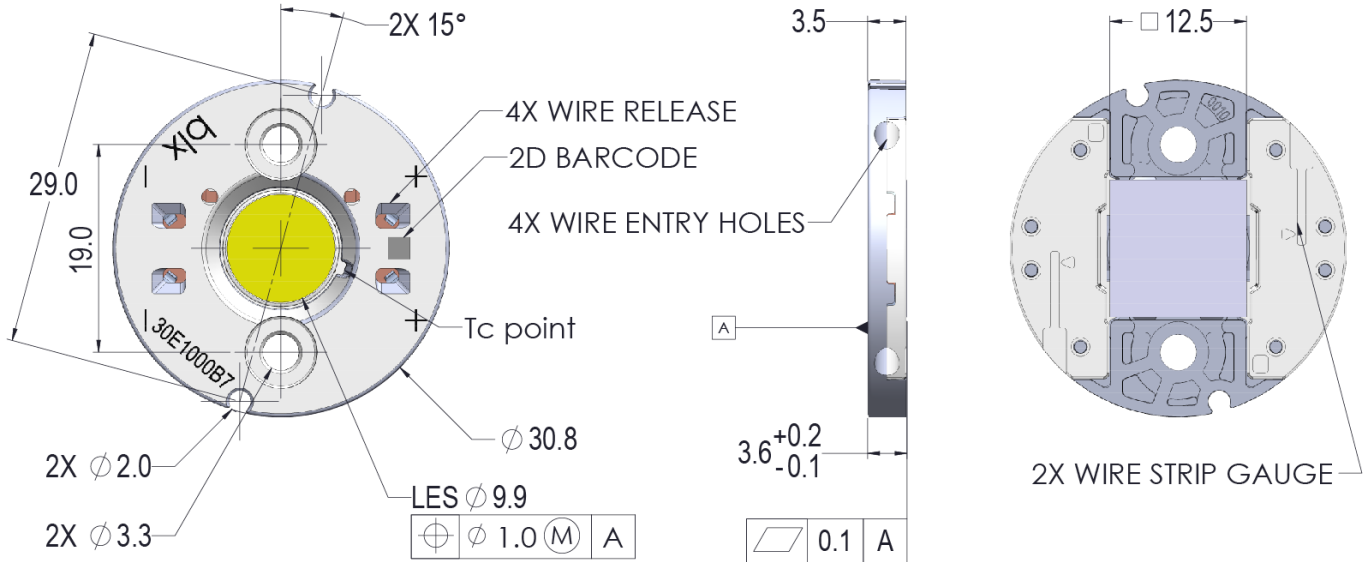

Notes for Figure 34:

1. Drawings are not to scale.
2. Drawing dimensions are in millimeters.
3. Unless otherwise specified, tolerances are ± 0.01 mm.
4. Mounting slots (2X) are for M2.5 screws.
5. Bridgelux recommends two tapped holes for mounting screws with 19.0 ± 0.10 mm center-to-center spacing.
6. Screws with flat shoulders (pan, dome, button, round, truss, mushroom) provide optimal torque control. Do NOT use flat, countersink, or raised head screws.
7. The optical center of the LED Array is nominally defined by the mechanical center of the array to a tolerance of ± 0.2 mm.
8. Bridgelux maintains a flatness of 0.10mm across the mounting surface of the array.

Mechanical Dimensions

Figure 35: Drawing for Vero SE 13 LED Array

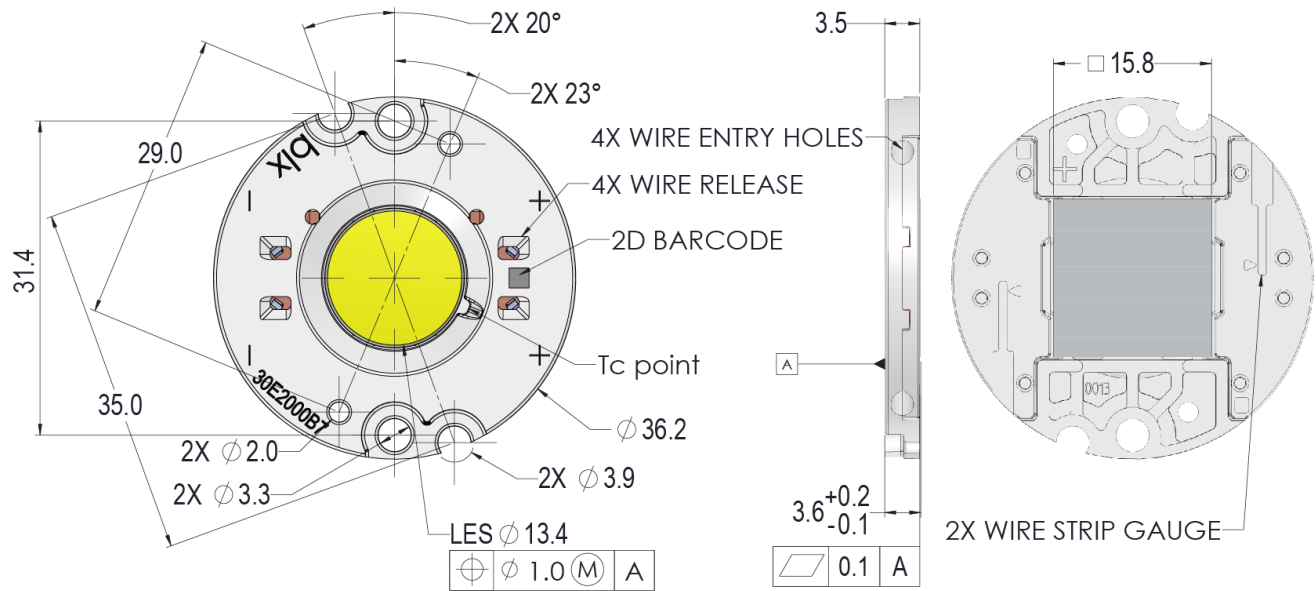

Notes for Figure 35:

1. Drawings are not to scale.
2. Drawing dimensions are in millimeters.
3. Unless otherwise specified, tolerances are $\pm 0.01\text{mm}$.
4. Mounting holes (2X) are for M2.5 screws.
5. Bridgelux recommends two tapped holes for mounting screws with $31.4 \pm 0.10\text{mm}$ center-to-center spacing.
6. Screws with flat shoulders (pan, dome, button, round, truss, mushroom) provide optimal torque control. Do NOT use flat, countersink, or raised head screws.
7. The optical center of the LED Array is nominally defined by the mechanical center of the array to a tolerance of $\pm 0.2\text{mm}$.
8. Bridgelux maintains a flatness of 0.10mm across the mounting surface of the array.

Mechanical Dimensions

Figure 36: Drawing for Vero SE 18 LED Array

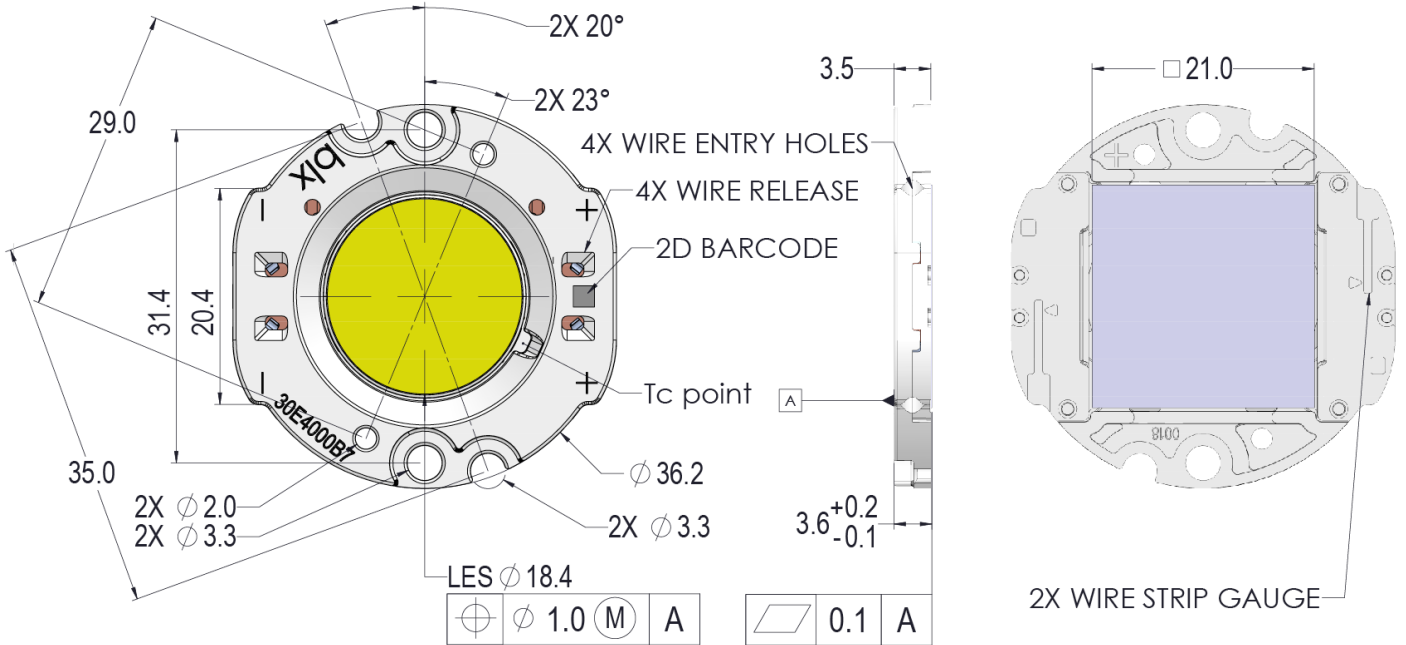

Notes for Figure 36:

1. Drawings are not to scale.
2. Drawing dimensions are in millimeters.
3. Unless otherwise specified, tolerances are ± 0.01 mm.
4. Mounting holes (2X) are for M2.5 screws.
5. Bridgelux recommends two tapped holes for mounting screws with 31.4 ± 0.10 mm center-to-center spacing.
6. Screws with flat shoulders (pan, dome, button, round, truss, mushroom) provide optimal torque control. Do NOT use flat, countersink, or raised head screws.
7. The optical center of the LED Array is nominally defined by the mechanical center of the array to a tolerance of ± 0.2 mm.
8. Bridgelux maintains a flatness of 0.10mm across the mounting surface of the array.

Mechanical Dimensions

Figure 37: Drawing for Vero SE 29 LED Array

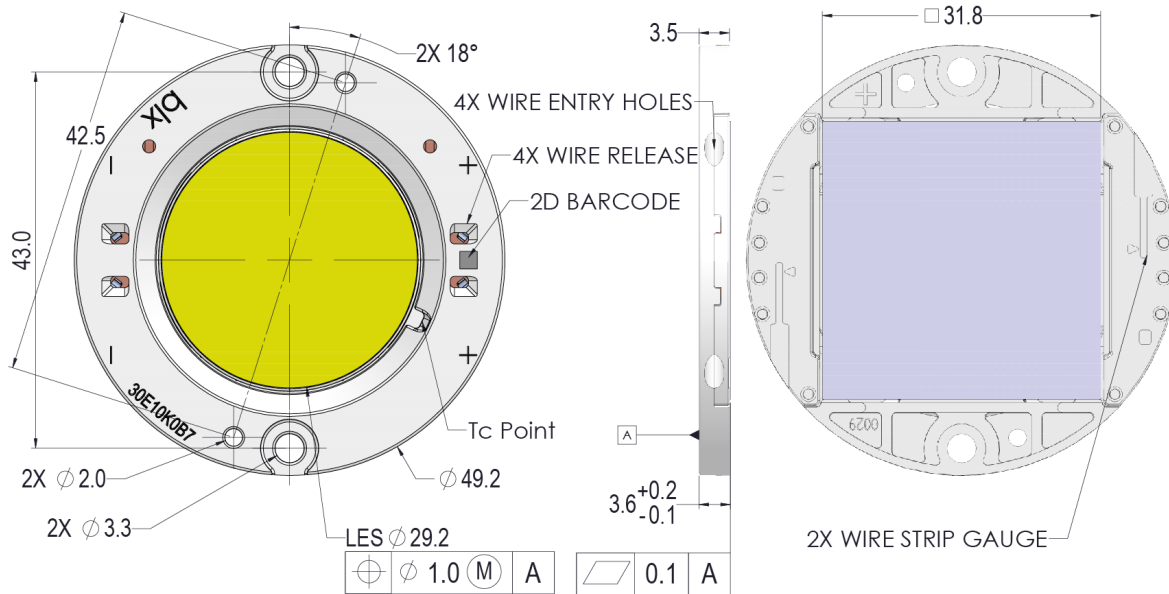

Notes for Figure 37:

1. Drawings are not to scale.
2. Drawing dimensions are in millimeters.
3. Unless otherwise specified, tolerances are ± 0.01 mm.
4. Mounting holes (2X) are for M3 screws.
5. Bridgelux recommends two tapped holes for mounting screws with 43.0 ± 0.10 mm center-to-center spacing.
6. Screws with flat shoulders (pan, dome, button, round, truss, mushroom) provide optimal torque control. Do NOT use flat, countersink, or raised head screws.
7. The optical center of the LED Array is nominally defined by the mechanical center of the array to a tolerance of ± 0.2 mm.
8. Bridgelux maintains a flatness of 0.10mm across the mounting surface of the array.

Packaging and Labeling

Figure 38: Drawing for Vero SE 10 Packaging Tray

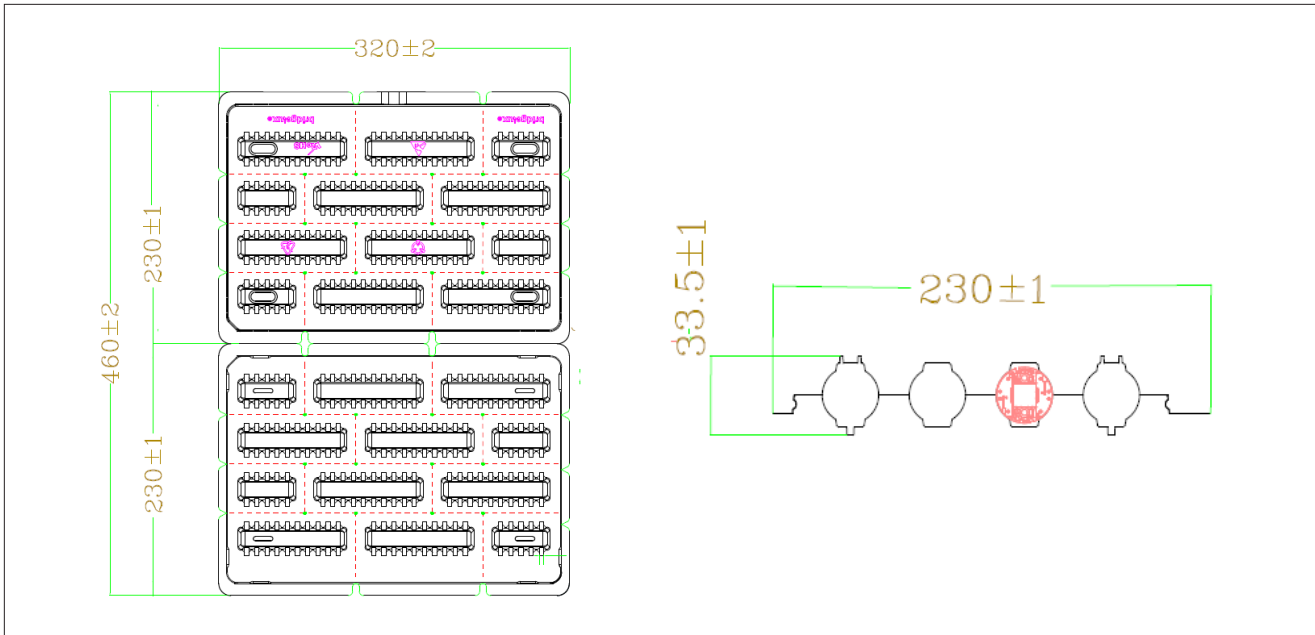

Notes for Figure 38:

1. Dimensions are in millimeters.
2. Drawings are not to scale.

Figure 39: Drawing for Vero SE 13 Packaging Tray

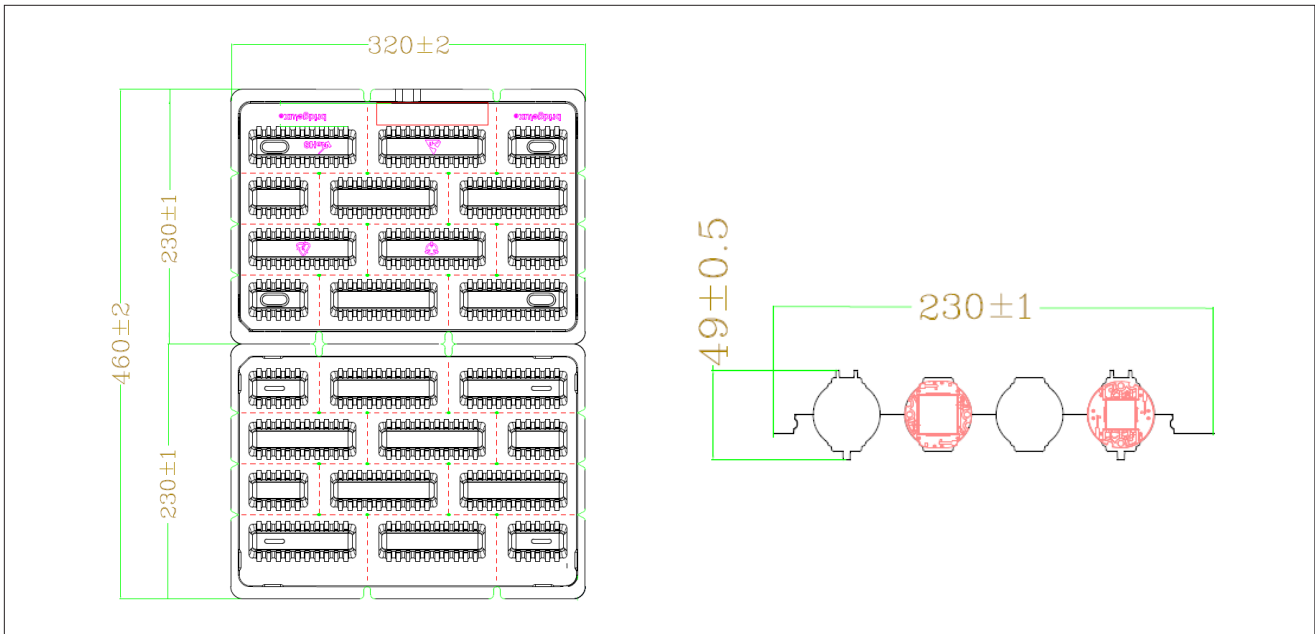

Notes for Figure 39:

1. Dimensions are in millimeters.
2. Drawings are not to scale.

Packaging and Labeling

Figure 40: Drawing for Vero SE 18 Packaging Tray

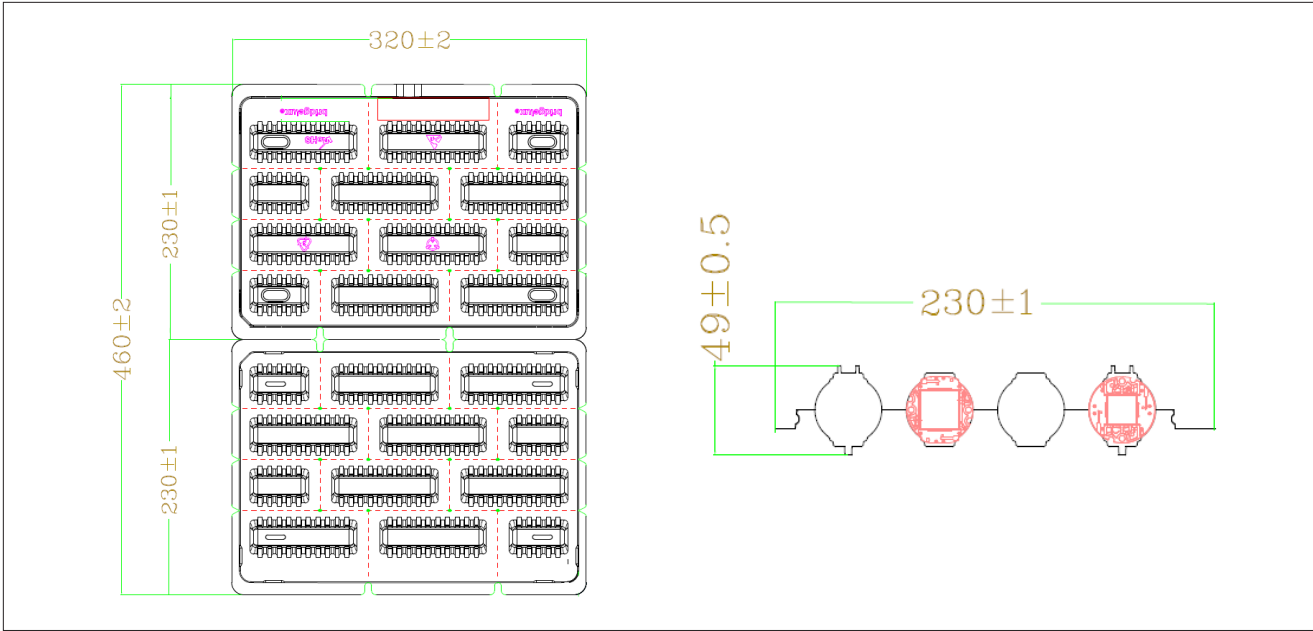

Notes for Figure 40:

1. Dimensions are in millimeters.
2. Drawings are not to scale.

Figure 41: Drawing for Vero SE 29 Packaging Tray

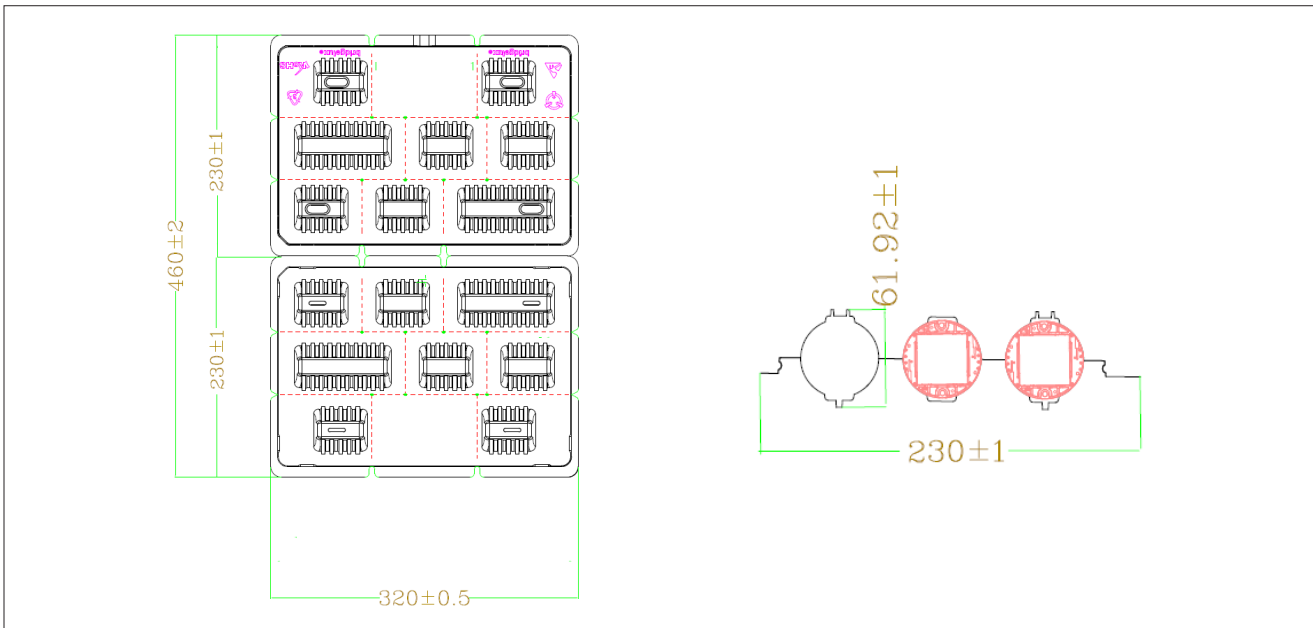

Notes for Figure 41:

1. Dimensions are in millimeters.
2. Drawings are not to scale.

Packaging and Labeling

Figure 42: Vero SE Series Packaging and Labeling

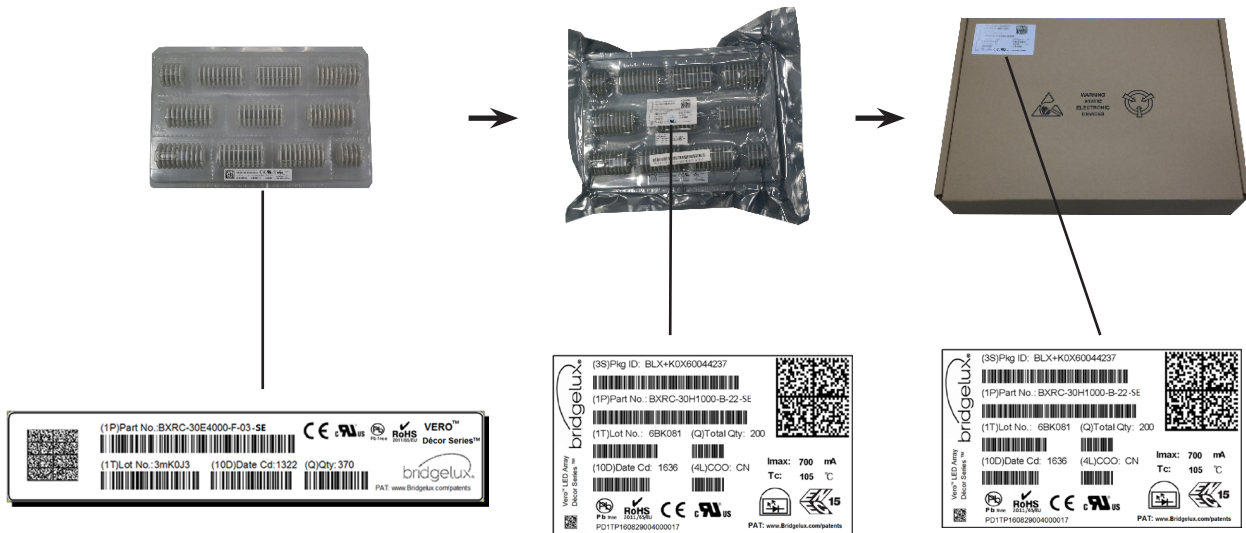

Notes for Figure 42:

1. Each tray holds 100 COBs for Vero 10 SE, Vero 13 SE, and Vero 18 SE and 50 COBs for Vero 29 SE.
2. Each tray is vacuum sealed in an antistatic bag and placed in its own box.
3. Each tray, bag and box is to be labeled as shown above.

Figure 43: Vero SE Product Labeling

Bridgelux COB arrays have laser markings on the back side of the substrate to help with product identification. In addition to the product identification markings, Bridgelux COB arrays also contain markings for internal Bridgelux manufacturing use only. The image below shows which markings are for customer use and which ones are for Bridgelux internal use only. The Bridgelux internal manufacturing markings are subject to change without notice, however these will not impact the form, function or performance of the COB array.



Design Resources

Optical Source Models

Optical source models and ray set files are available for all Bridgelux products. For a list of available formats, visit www.bridgelux.com.

3D CAD Models

Three dimensional CAD models depicting the product outline of all Bridgelux Vero LED arrays are available in both IGS and STEP formats. Please contact your Bridgelux sales representative for assistance.

LM80

LM80 testing is on going. Please contact your Bridgelux sales representative for more information.

Precautions

CAUTION: CHEMICAL EXPOSURE HAZARD

Exposure to some chemicals commonly used in luminaire manufacturing and assembly can cause damage to the LED array. Please consult Bridgelux Application Note AN31 for additional information.

CAUTION: RISK OF BURN

Do not touch the Vero SE LED array during operation. Allow the array to cool for a sufficient period of time before handling. The Vero SE LED array may reach elevated temperatures such that could burn skin when touched.

CAUTION

CONTACT WITH LIGHT EMITTING SURFACE (LES)

Avoid any contact with the LES. Do not touch the LES of the LED array or apply stress to the LES (yellow phosphor resin area). Contact may cause damage to the LED array.

Optics and reflectors must not be mounted in contact with the LES (yellow phosphor resin area). Optical devices may be mounted on the top surface of the plastic housing of the Vero SE LED array. Use the mechanical features of the LED array housing, edges and/or mounting holes to locate and secure optical devices as needed.

Disclaimers

MINOR PRODUCT CHANGE POLICY

The rigorous qualification testing on products offered by Bridgelux provides performance assurance. Slight cosmetic changes that do not affect form, fit, or function may occur as Bridgelux continues product optimization.

STANDARD TEST CONDITIONS

Unless otherwise stated, array testing is performed at the nominal drive current.

About Bridgelux: We Build Light That Transforms

At Bridgelux, we help companies, industries and people experience the power and possibility of light. Since 2002, we've designed LED solutions that are high performing, energy efficient, cost effective and easy to integrate. Our focus is on light's impact on human behavior, delivering products that create better environments, experiences and returns—both experiential and financial. And our patented technology drives new platforms for commercial and industrial luminaires.

For more information about the company, please visit
bridgelux.com
twitter.com/Bridgelux
facebook.com/Bridgelux
linkedin.com/company/Bridgelux-inc-_2
WeChat ID: BridgeluxInChina



101 Portola Avenue
Livermore, CA 94551
Tel (925) 583-8400
Fax (925) 583-8401
www.bridgelux.com

© 2016 Bridgelux, Inc. All rights reserved 2016. Product specifications are subject to change without notice. Bridgelux, the Bridgelux stylized logo design and Vero are registered trademarks, and Décor Series is a trademark of Bridgelux, Inc. All other trademarks are the property of their respective owners.

Bridgelux Décor Series Class A on Vero SE Series Product Data Sheet DS125 Rev A (10/2016)