

POWER MANAGEMENT

Features

- Input voltage range — 2.3V to 5.5V
- Two 300mA (maximum) outputs
- Dropout at 300mA load — 180mV (Typ)
- Quiescent supply current — 50µA (x2)
- Shutdown current — 100nA
- Output noise — $100\mu V_{RMS}/V$
- Over-temperature protection
- Short-circuit protection
- Under-voltage lockout
- Internal output discharge 100Ω
- MLPD-UT8, 1.6mm x 1.2mm x 0.6mm package

Applications

- Consumer electronics
- Wearable & Portable electronics
- Cell phones
- GPS devices
- Set top boxes/HDTVs
- Communication electronics
- Industrial electronics

Description

The SC563 is a dual output, low dropout linear voltage regulator designed for use in battery powered applications and other applications with space constraints and low power requirements. The SC563 provides fixed output voltages up to 300mA of load current per channel. Fixed output voltages for each output eliminates the need for external feedback resistors.

The device has separate input, output and enable pins for each LDO channel. Using the lowest possible input voltage for each output voltage reduces the power loss for each rail. This improves overall package thermal performance and efficiency compared to single input voltage devices.

The device has fast turn-on and turn-off voltage slew rate for fast system start up and reset response. Low quiescent current extends battery life.

The SC563 family of devices provide protection circuitry such as short-circuit protection, under-voltage lockout, and thermal protection to prevent device failures. Stability is maintained by using $1\mu F$ capacitors on the output pins. The MLPD-UT8 1.6mmx1.2mm package and small ceramic bypass capacitors minimize the required PCB area.

Typical Application Circuit

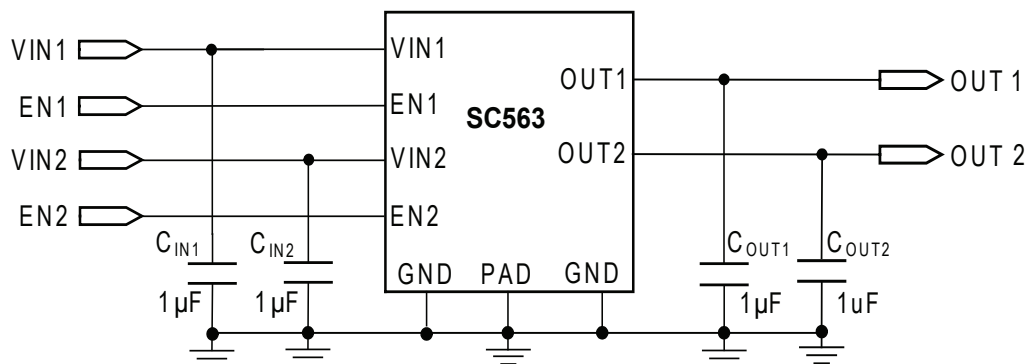

Pin Configuration

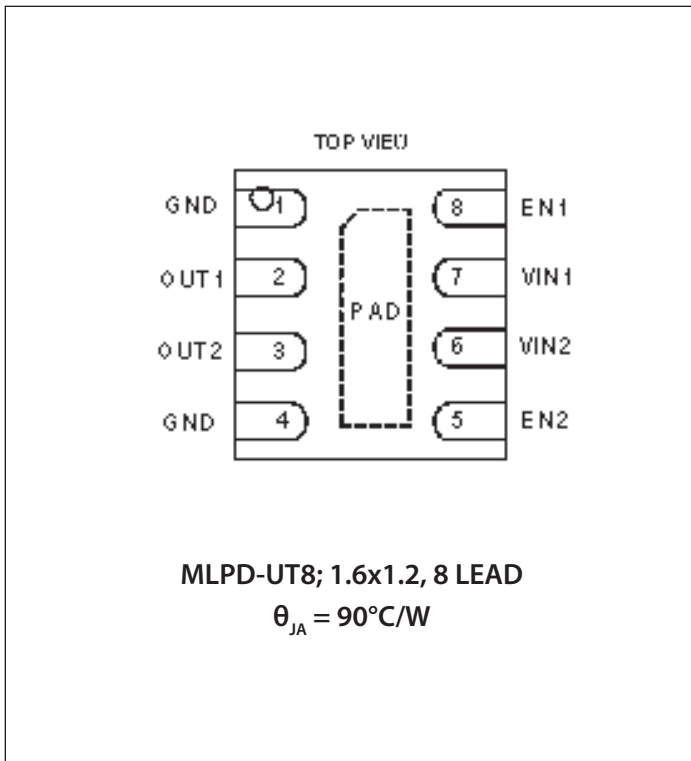

Ordering Information

Device	Package
SC563LHULTRC ⁽¹⁾⁽²⁾	MLPD-UT8 1.6x1.2
SC563LHEVB ⁽³⁾	Evaluation Board

Notes:

- (1) Available in tape and reel only. A reel contains 3,000 devices.
- (2) Lead-free package only. Device is WEEE and RoHS compliant.
- (3) See the Voltage Options Table for Manufacture Part Number

Voltage Options and Part Numbering

Device	Ordering Number	Output Voltage Options		Marking Code	Auto-Discharge
		OUT1	OUT2		
SC563LH	SC563LHULTRC	3.3V	1.8V	LH	Yes

Note: For additional Fixed Output Voltage Options, contact Semtech marketing.

Marking Information

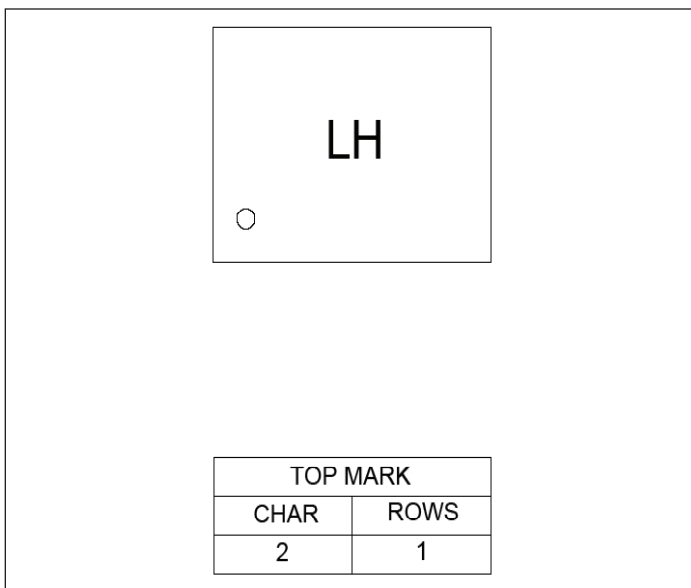

Absolute Maximum Ratings

VIN1, VIN2 (V).....	-0.3 to +6.0
EN1, EN2(V)	-0.3 to +6.0
Pin Voltage — All Other Pins (V)	-0.3 to (V _{VIN} + 0.3)
ESD ⁽¹⁾ PROTECTION LEVEL (KV).....	4

Recommended Operating Conditions

Ambient Temperature Range (°C).....	-40 ≤ T _A ≤ +85
V _{VIN} (V).....	2.3 to 5.5
EN1 to GND(V).....	0 to VIN1
EN2 to GND(V).....	0 to VIN2

Thermal Information

Thermal Resistance, Junction to Ambient ⁽²⁾ (°C/W)	90
Maximum Junction Temperature (°C)	+125
Storage Temperature Range (°C).....	-65 to +150
Peak IR Reflow Temperature (10s to 30s) (°C)	+260

Exceeding the above specifications may result in permanent damage to the device or device malfunction. Operation outside of the parameters specified in the Electrical Characteristics section is not recommended.

NOTES:

(1) Tested according to JEDEC standard JESD22-A114-B.

(2) Calculated from package in still air, mounted to 3 x 4.5 (in), 4 layer FR4 PCB with thermal vias under the exposed pad per JESD51 standards.

Electrical Characteristics

Unless otherwise noted V_{VIN} = Max[V_{OUTX} + 1.0V or 2.3V], C_{IN1} = C_{IN2} = 1μF, C_{OUT1} = C_{OUT2} = 1μF, V_{EN1} = V_{EN2} = V_{VIN'}, -40 °C ≤ T_A = T_J ≤ 125°C. Typical values are at T_A = 25°C. All specifications apply to both LDOs unless otherwise noted.

Parameter	Symbol	Conditions	Min	Typ	Max	Units
Input Supply Voltage Range	V _{IN}		2.3		5.5	V
Output Voltage Accuracy ⁽¹⁾	ΔV _{OUTX}	I _{OUTX} = 1mA, V _{IN} ≥ Max(V _{OUTX} + 1.0V or 2.3V)	-3	+/- 2	3	%
Maximum Output Current	I _{MAX}	Each LDO	300			mA
Dropout Voltage ⁽²⁾	V _D	I _{OUTX} = 300mA, V _{INX} = 3.0V to 3.6V		180	450	mV
		I _{OUTX} = 300mA, V _{INX} = 3.0V to 3.6V, -40°C ≤ T _A ≤ 85°C		180	400	mV
		I _{OUTX} = 300mA, V _{INX} = 2.3V to 3.0V		300	540	mV
		I _{OUTX} = 300mA, V _{INX} = 2.3V to 3.0V -40°C ≤ T _A ≤ 85°C		300	490	mV
Shutdown Current	I _{SD}	ENx=0,		0.1	1	μA
Quiescent Current	I _Q	I _{OUTX} = 0mA, V _{ENX} = V _{INX} (per LDO)		50		μA
Load Regulation	ΔV _{LOADX}	I _{OUTX} = 1mA to I _{MAX} , -40 °C < T _A <=85°C		5	40	mV
Line Regulation	ΔV _{LINEX}	I _{OUTX} = 1mA, -40 °C < T _A <=85°C		0.02	0.1	%/V

Electrical Characteristics (continued)

Parameter	Symbol	Conditions	Min	Typ	Max	Units
Current Limit	I_{LIMx}		350	550	750	mA
Noise	e_N	$R_{load} = 50\Omega$, $10\text{Hz} < f < 100\text{kHz}$		100		$\mu\text{V}_{RMS}/\text{V}$
Power Supply Rejection Ratio	PSRR	$I_{OUTx} = 5\text{mA}$, $f = 1\text{kHz}$,		60		dB
Under Voltage Lockout	V_{UVLOx}	V_{IN} Rising	1.95	2.1	2.25	V
UVLO Hysteresis	$V_{UVLO-HYS}$			100		mV
Over Temperature Protection Threshold ⁽³⁾	T_{OT}	Temperature Rising		150		°C
Over Temperature Threshold Hysteresis	V_{OT-HYS}			10		°C
Digital Inputs						
Logic Input High Threshold	V_{IH}	$V_{IN} = 5.5\text{V}$	1.2			V
Logic Input Low Threshold	V_{IL}	$V_{IN} = 2.5\text{V}$			0.4	V
Logic Input High Current	I_{IH}	$V_{IN} = 5.5\text{V}$			1.5	μA
Logic Input Low Current	I_{IL}	$V_{IN} = 5.5\text{V}$			1	μA

Notes:

- (1) X indicates LDO1 or LDO2.
- (2) Dropout voltage is defined as $V_{IN} - V_{OUTx}$, when V_{OUTx} is 100mV below the value of V_{OUTx} at $V_{IN} \geq \text{Max}(V_{OUTx} + 1.0\text{V or } 2.3\text{V})$.
- (3) Thermal shutdown does not latch LDOs off. Recovery begins if the temperature drops by the hysteresis level.

Pin Configurations and Descriptions

SC563	Pin Name	Pin Function
1	GND	Ground
2	OUT1	Output for LDO1 -- bypass with a 1uF capacitor
3	OUT2	Output for LDO2 -- bypass with a 1uF capacitor
4	GND	Ground
5	EN2	Enable for LDO2, internal 5 M Ω pull low.
6	VIN2	Input supply for LDO2 -- bypass with a 1uF capacitor
7	VIN1	Input supply for LDO1 -- bypass with a 1uF capacitor
8	EN1	Enable for LDO1, internal 5 M Ω pull low.
	PAD	Heat sink pad, connect to ground on PCB.

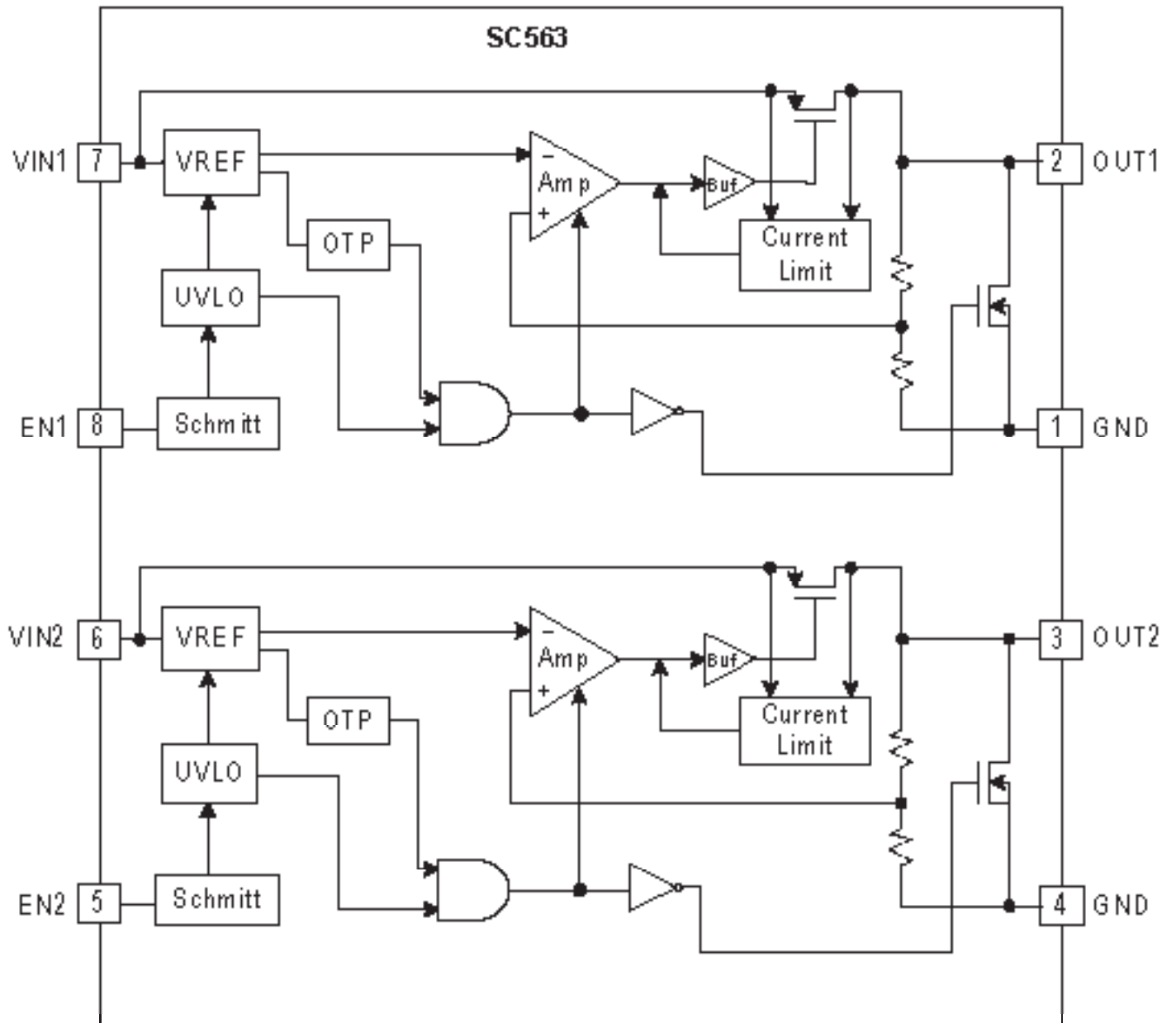
Block Diagram

Typical Characteristics

Load Regulation (Vin=3.6V, Vout=3.3V)

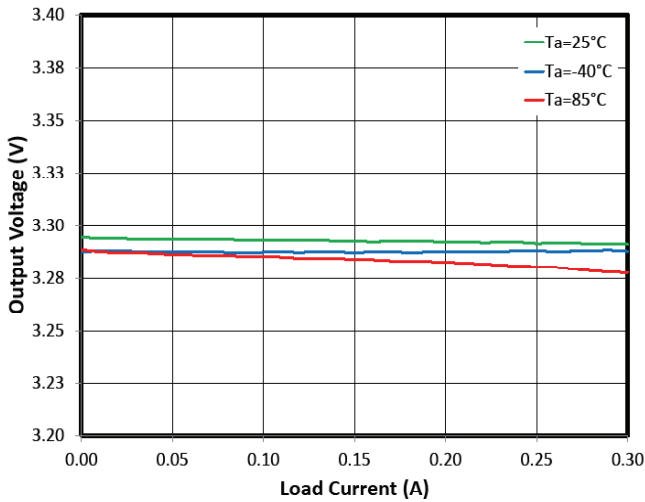

Load Regulation (Vin=5.0V, Vout=3.3V)

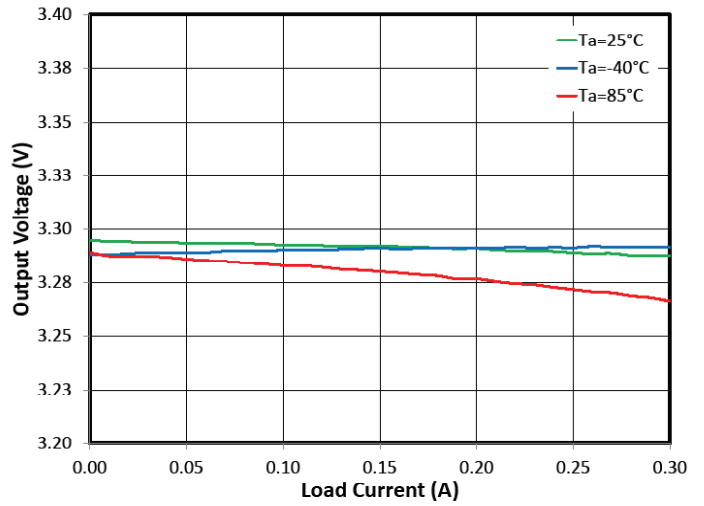

Load Regulation (Vin=3.6V, Vout=1.8V)

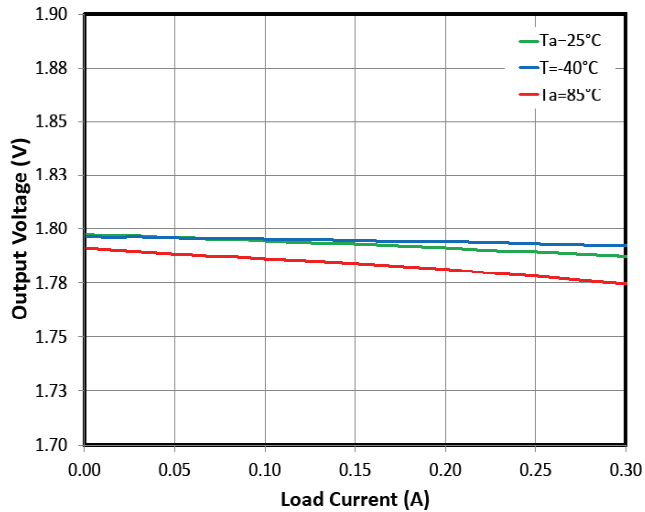

Load Regulation (Vin=4.2V, Vout=1.8V)

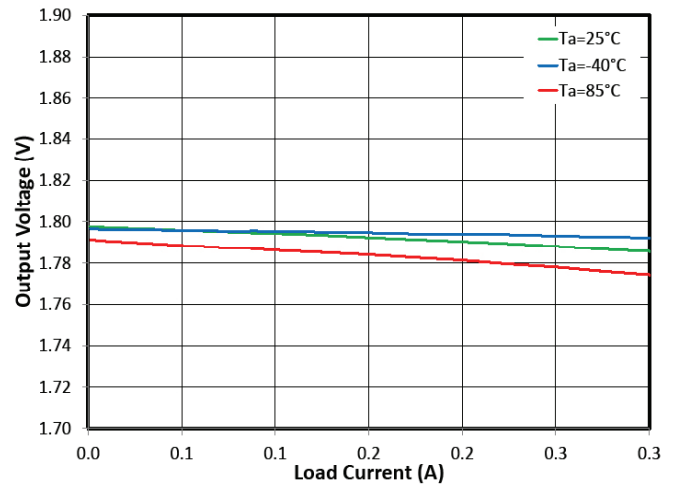

Line Regulation (Vout=3.3V, Iout=150mA)

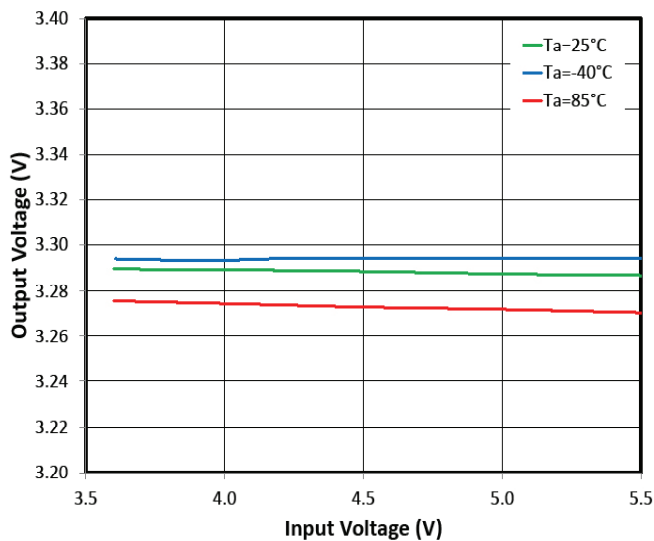

Line Regulation (Vout=3.3V, Iout=300mA)

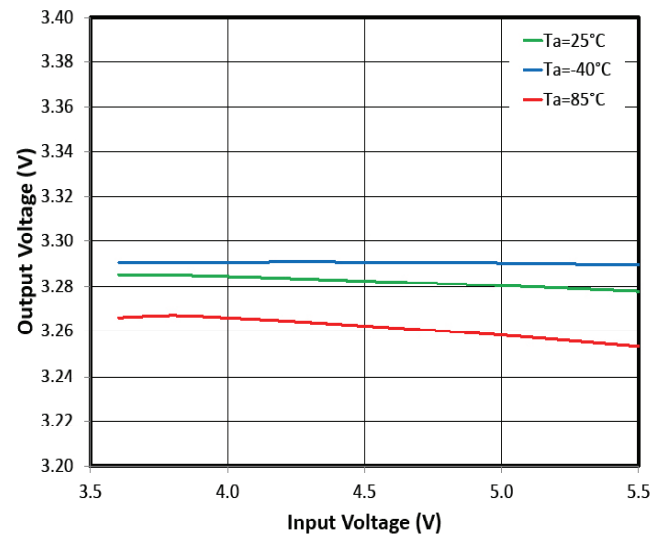

Typical Characteristics

Line Regulation (Vout=1.8V, Iout=150mA)

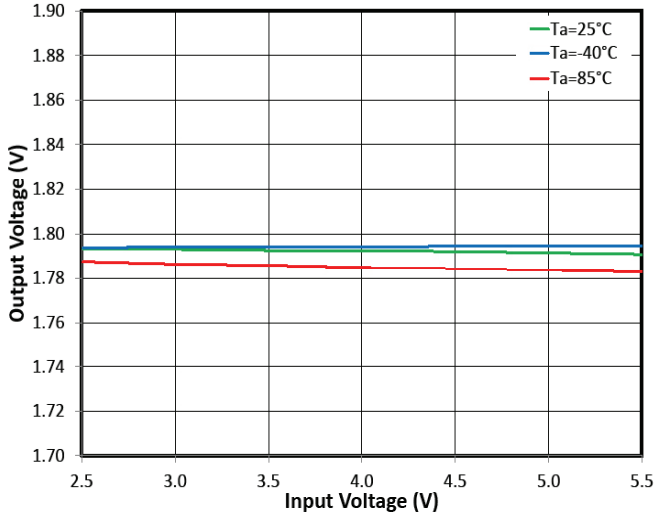

Line Regulation (Vout=1.8V, Iout=250mA)

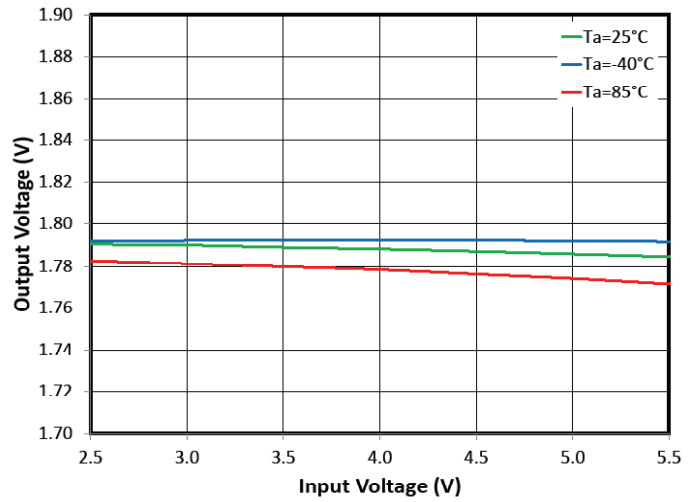

Dropout Voltage (Vout=3.3V, Iout=50mA)

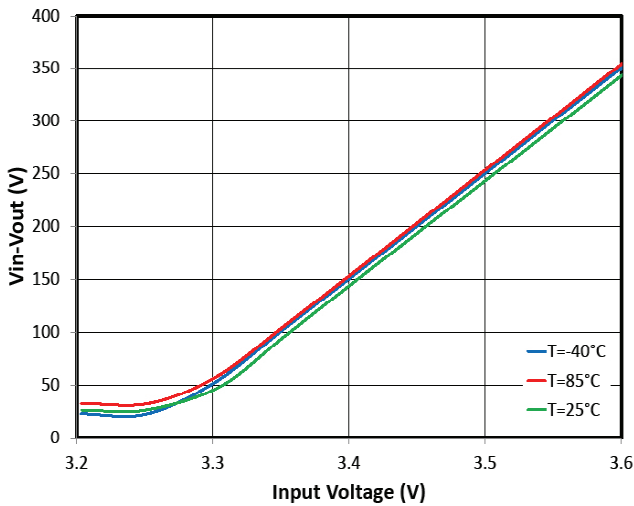

Dropout Voltage (Vout=3.3V, Iout=150mA)

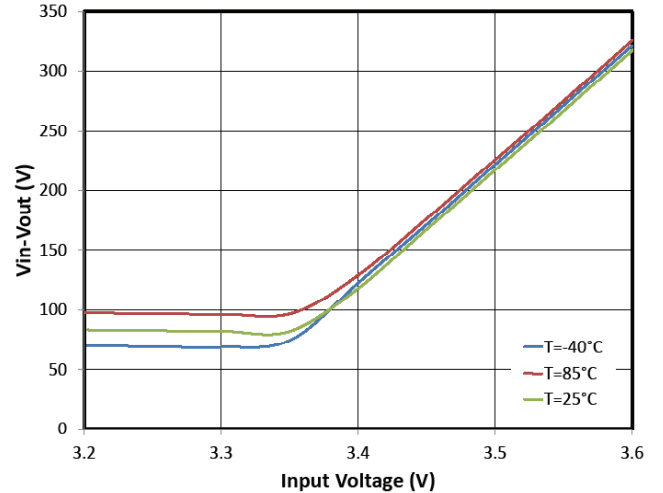

Dropout Voltage (Vout=3.3V, Iout=300mA)

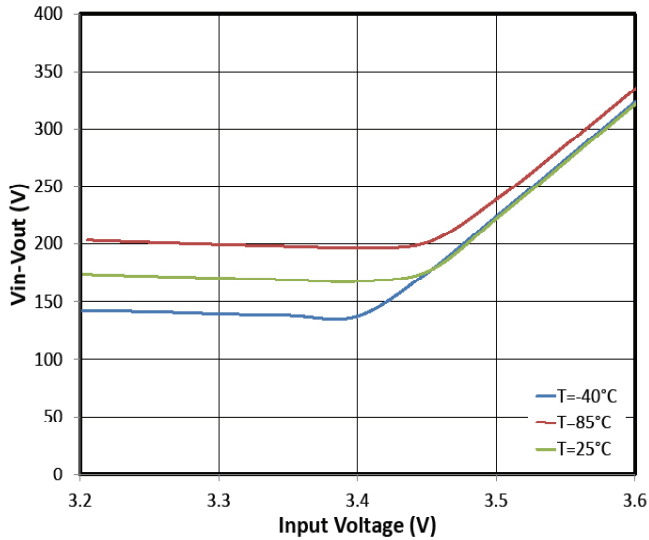

Dropout Vs Load Current (Vout=3.3V)

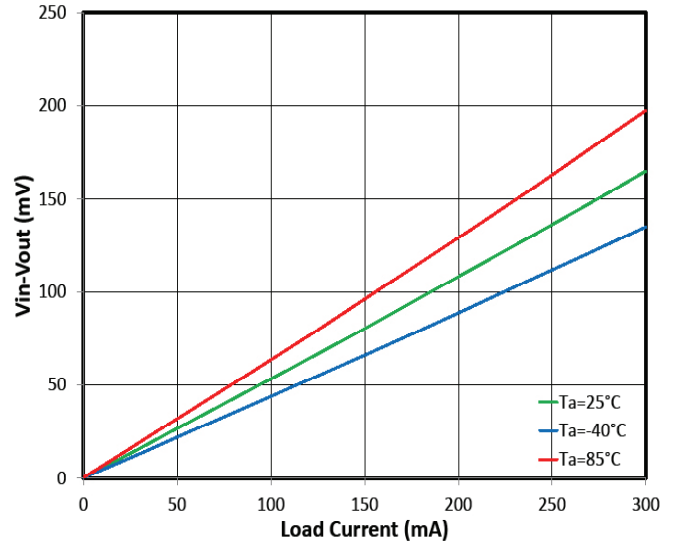

Typical Characteristics

Start Up Via V_{IN} ($V_{OUT}=3.3V$)

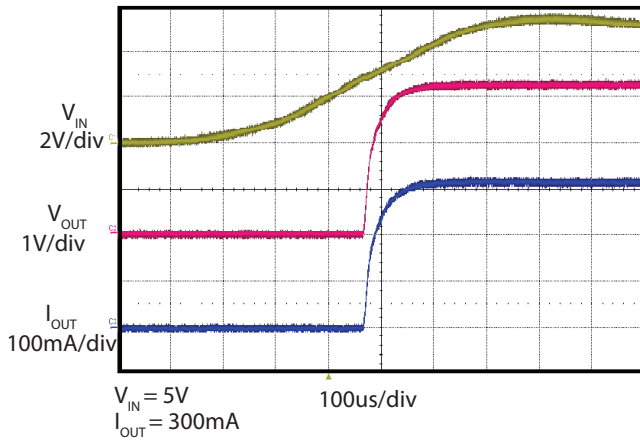

Start Up (Enable) ($V_{OUT}=3.3V$)

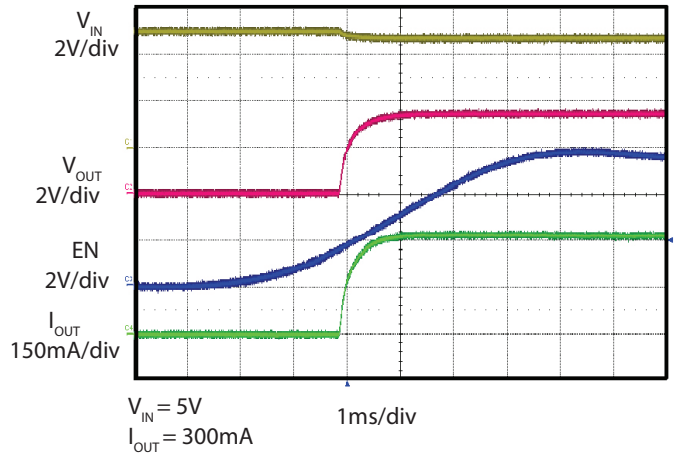

Start Up Via V_{IN} ($V_{OUT}=1.8V$)

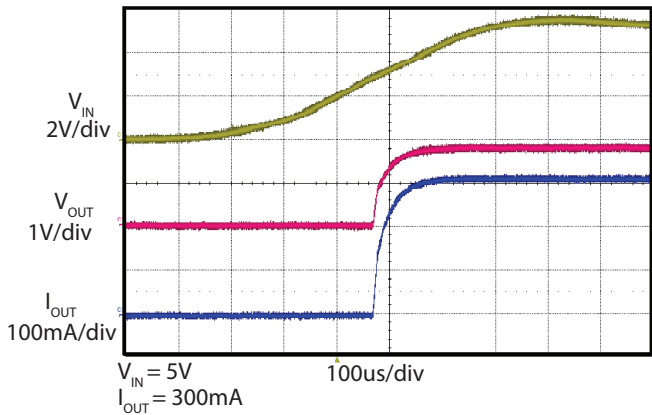

Start Up (Enable) ($V_{OUT}=1.8V$)

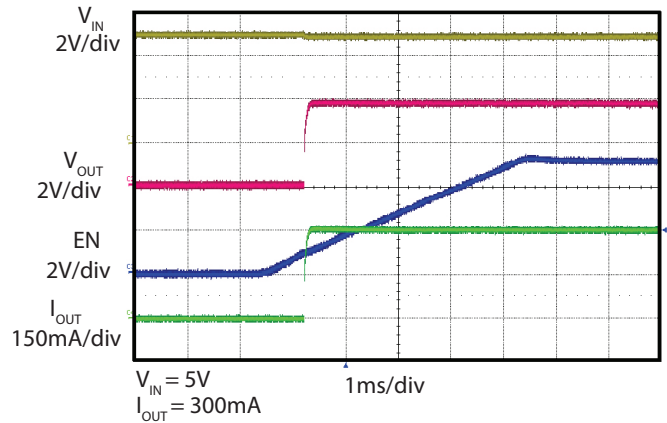

Shutdown ($V_{OUT}=3.3V$)

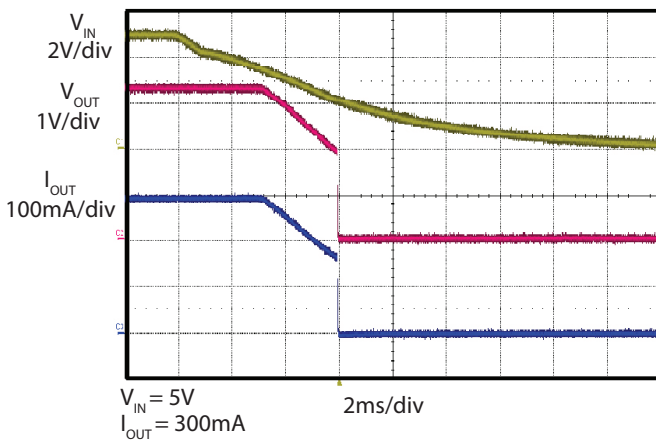

Shutdown ($V_{OUT}=1.8V$)

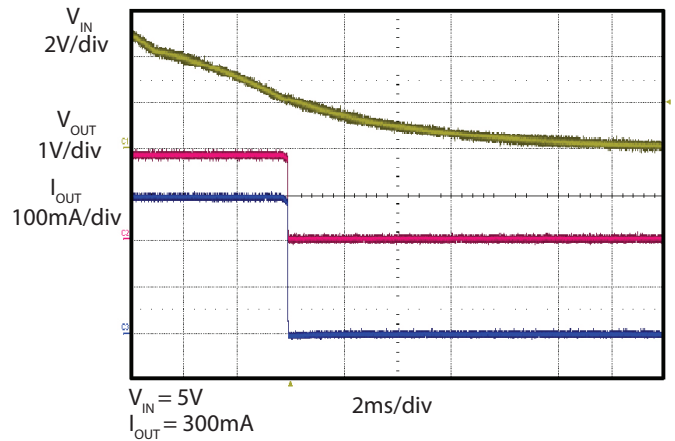

Typical Waveforms

LDO1=3.3V, 0 to 300mA Load Transient

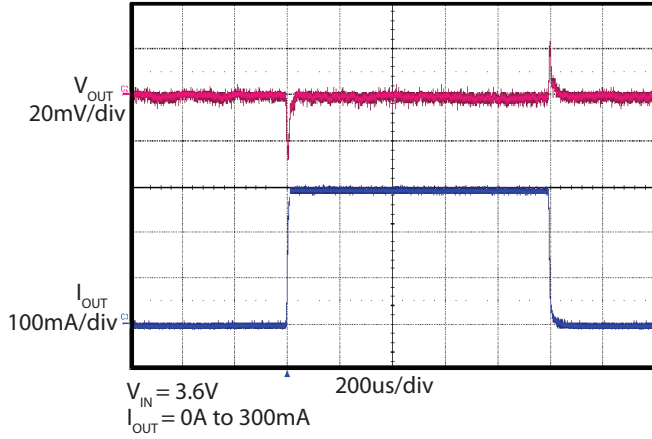

LDO2=1.8V, 0 to 300mA Load Transient

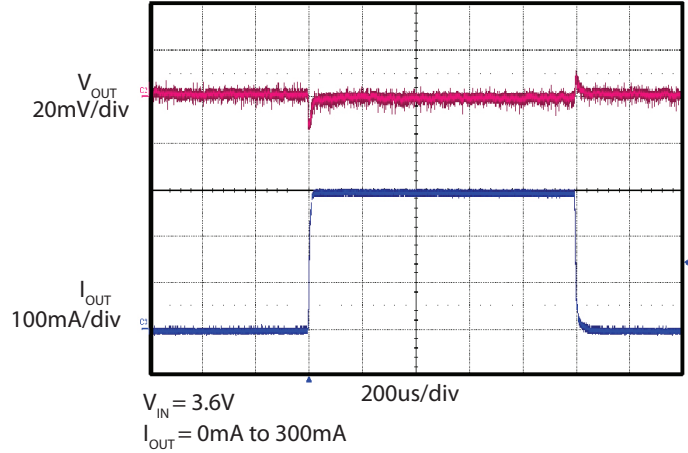

LDO1=3.3V, 0 to 300mA Load Transient

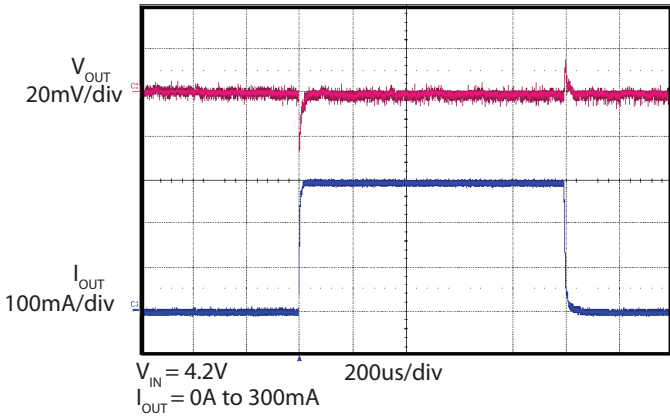

LDO2=1.8V, 0 to 300mA Load Transient

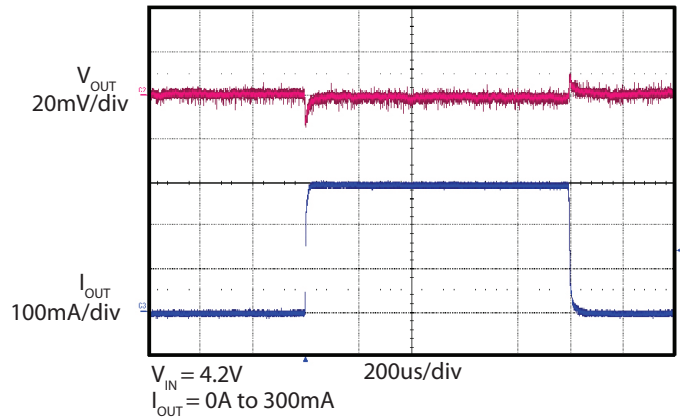

LDO1=3.3V, 0 to 300mA Load Transient

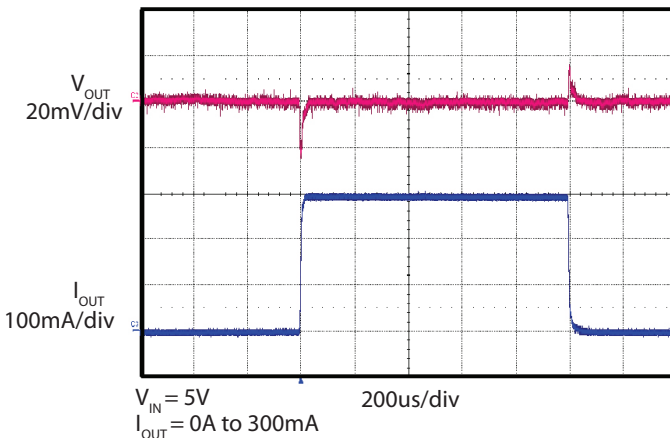

LDO2=1.8V, 0 to 300mA Load Transient

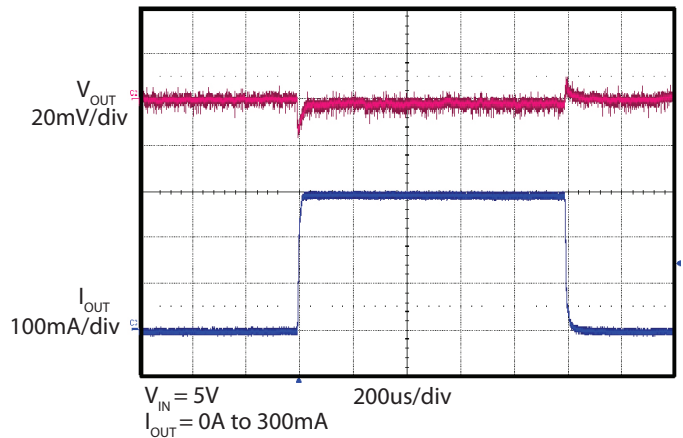

Typical Waveforms

LDO1=3.3V Noise Spectral Density

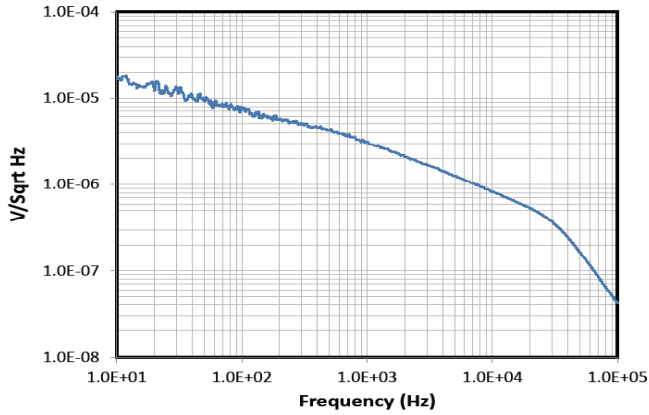

$V_{IN} = 5.4V, V_{OUT} = 3.3V, \text{Load } 50 \text{ Ohms}$

LDO2=1.8V Noise Spectral Density

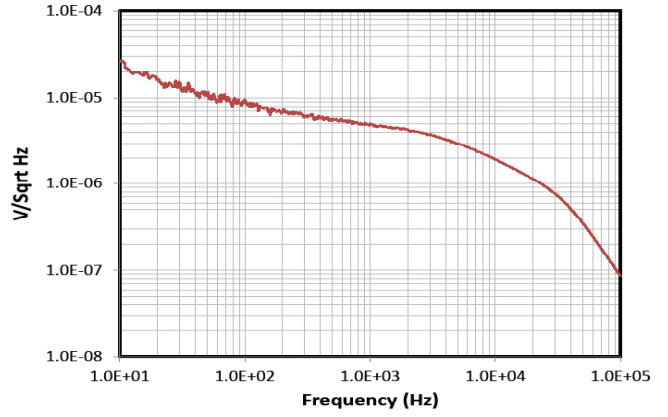

$V_{IN} = 5.4V, V_{OUT} = 3.3V, \text{Load } 50 \text{ Ohms}$

LDO2=1.8V, PSRR, Iout=30mA

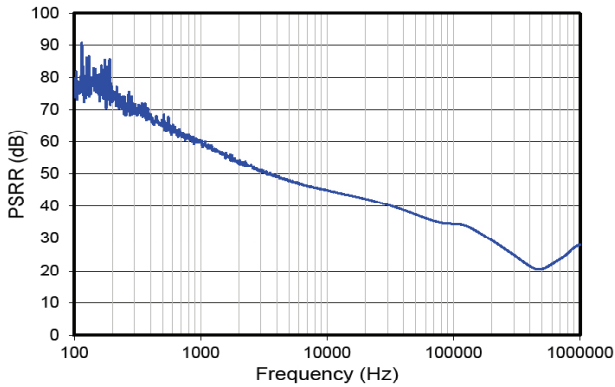

LDO2=1.8V, PSRR, Iout=100mA

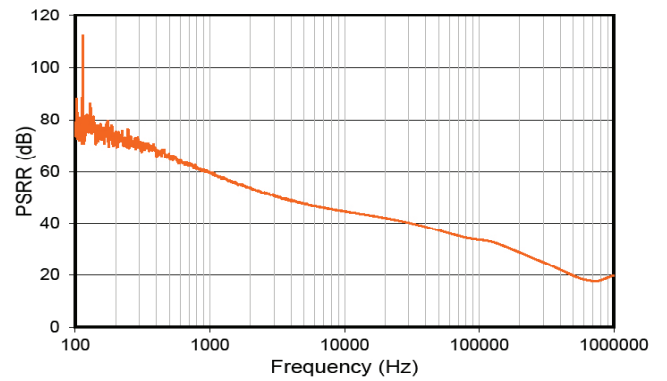

Applications Information

General Description

The SC563 is a dual output linear regulator with low dropout voltage, low supply current, and low output noise. The device provides a simple, low cost solution with minimal PCB area. It has a miniature package size and needs four 1 μ F 0402 size external capacitors for its input and output.

The dual LDOs are powered from separate input supply pins. Each LDO provides up to 300mA output current.

Power On and Off Control and Turn-on Delay

The SC563 device has separate enable pins (EN1 and EN2) that control the LDO outputs respectively. Pulling enable pin high will enable the device when the V_{in} is above the its UVLO level at about 2.4V. Pulling this pin low causes the device to shutdown where it typically draws 100nA from the input supply.

When the enable pins are connected to the input voltage supply, the device turn-on and turn-off has two voltage thresholds to overcome. At the turn-on event, the enable pin voltage needs to be greater than the enable threshold and the V_{in} voltage needs to be higher than the UVLO. The higher of the two voltages, which is the UVLO, determines the turn on time. At turn-off, the first condition of either enable threshold low or the V_{in} UVLO will determine the turn-off event.

After the enable goes high, the IC has a delay time before the output voltage ramps up. The delay is typically between 120 μ s to 510 μ s. The 510 μ s is related to the lower V_{in} condition.

With 1 μ F output capacitor (capacitor part number: GRM155R61A105KE15) at no load conditions, the output voltage ramp time is typically at 15 μ s. The device has an internal discharge MOSFET to discharge the output voltage at disable, the typical discharge time is at 2ms. The enable and disable waveforms are illustrated in Figure

1 and the Oscilloscope waveform is shown in the Typical Characteristics.

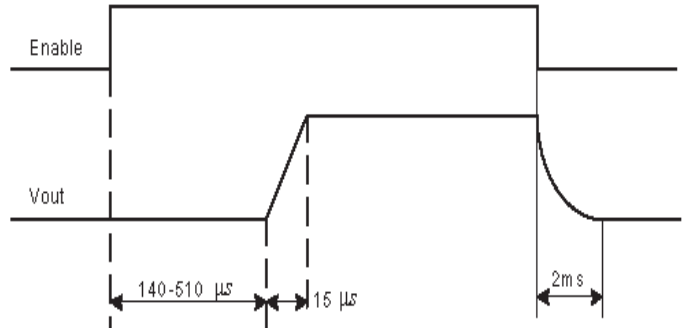

Figure 1 — Timing Diagram

The Output Noise

LDO's noise generally is characterized through noise spectral density (NSD) and total RMS value in the frequency band between 10Hz to 100kHz. The noise spectral density can be measured using a network analyzer with active probes. The RMS noise value is obtained from the noise spectral density curve by taking the square root of the area within the frequency range from 10Hz to 100kHz.

The normalized output noise for SC563 is at a typical value of 100 μ Vrms/V. The generalized output voltage noise can be approximated by: $V_{rms} = V_{out} * 100 \mu V$.

Protection Features

The SC563 provides protection features to ensure that no damage is incurred in the event of a fault condition. These functions include:

- Under-Voltage Lockout
- Over-Temperature Protection
- Short-Circuit Protection with peak and fold-back current limit

Applications Information (continued)

Under-Voltage Lockout

The Under-Voltage Lockout (UVLO) circuit protects the device from operating in an unknown state if the input voltage supply is too low.

When either V_{IN} drops below the UVLO threshold, as defined in the Electrical Characteristics section, the corresponding LDO is disabled. The LDO is re-enabled when V_{IN} is increased above the hysteresis level. When powering up with V_{IN} below the UVLO threshold, the LDO remains disabled.

Over-Temperature Protection

Over-Temperature protection are separately available on both LDOs.

An internal Over-Temperature (OT) protection circuit monitors the internal junction temperature. When the temperature exceeds the OT threshold as defined in the Electrical Characteristics section, the OT protection disables the corresponding LDO output. When the temperature drops below its hysteresis value, the LDO output will resume.

Short-Circuit Protection

Each output has short-circuit protection with peak current limit and fold back current limit. If the output current exceeds the peak current limit, the output voltage will drop and the output current will be limited to its fold back current limit value. See the waveforms in the typical operation section. If the short circuit is removed or the load current reduces to below the fold back current limit, the LDO output will rise back into regulation.

Component Selection

SC563 is designed for PCB savings with small area. The recommended input and output capacitor is $1\mu\text{F}$ with 0402 package with part number GRM155R61A105KE15.

Although there is no maximum value of output capacitor specified, very large values may increase the rise time of the output voltages without affecting stability. It is recommended that the value of output capacitance be restricted to a maximum of $10\mu\text{F}$. Ceramic capacitors of type X5R or X7R should be used because of their low ESR

and stable temperature coefficients. Tantalum capacitors and Y5V capacitors are not recommended.

Thermal Considerations

Although each of the two LDOs in the SC563 can provide 300mA of output current, the maximum power dissipation in the device is restricted by the miniature package size. The graphs in Figures 2 can be used as a guideline to determine whether the input voltage, output voltages, output currents, and ambient temperature of the system result in power dissipation within the operating limits are met or if further thermal relief is required.

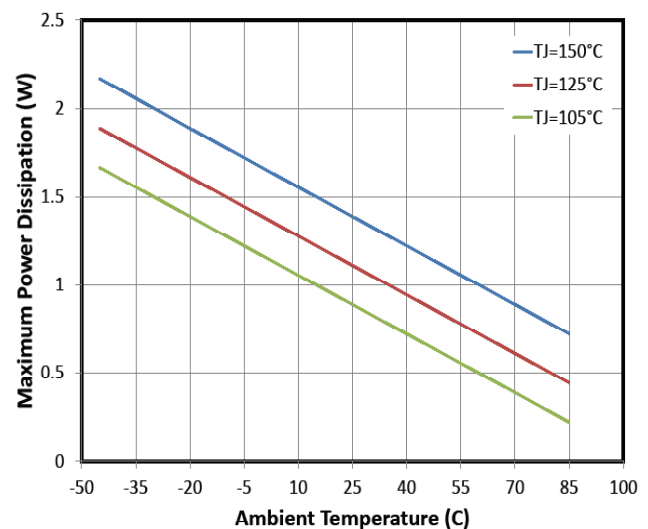

Figure 2 — Maximum P_D vs. T_A

The following procedure can be followed to determine if the thermal design of the system is adequate. The junction temperature of the SC563 can be determined in known operating conditions using the following equation:

$$T_J = T_A + (P_D \times \theta_{JA})$$

where

T_J = Junction Temperature (°C)

T_A = Ambient Temperature (°C)

P_D = Power Dissipation (W)

θ_{JA} = Thermal Resistance Junction to Ambient (°C/W)

Applications Information (continued)

Example

A SC563LH is used to provide outputs of 3.3V, 150mA from LDO1 and 1.8V, 250mA from LDO2. The input voltage is 4.2V for LDO1 and 2.5V for LDO2, and the ambient temperature of the system is 60°C.

$$P_D = 0.15X(4.2 - 3.3) + 0.25X(2.5 - 1.8)$$

$$= 0.31W$$

and

$$T_J = 60 + (0.31 \times 90) = 87.9^\circ\text{C}$$

This calculation shows the junction temperature is 87.9°C and it is below the maximum junction temperature of 125°C for this power dissipation. This example also demonstrates that with separate input voltages for LDO1 and LDO2, the total power dissipation can be reduced with the lower LDO output voltage fed by a lower input voltage.

Layout Considerations

The diagram in Figure 3 below illustrates proper layout of a circuit. The layout considerations are listed below:

- Attach the thermal pad of the device to a copper pad with vias connected to the GND plane. This enables better heat transfer from the device to the PCB.
- Place the input and output capacitors close to the device for optimal transient response and device behavior. Extra copper trace length between the device input and output to the capacitor soldering pad introduces parasitic inductance.
- Connect all ground connections of the input

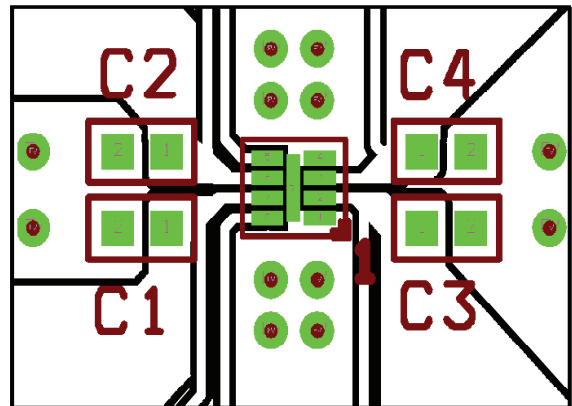
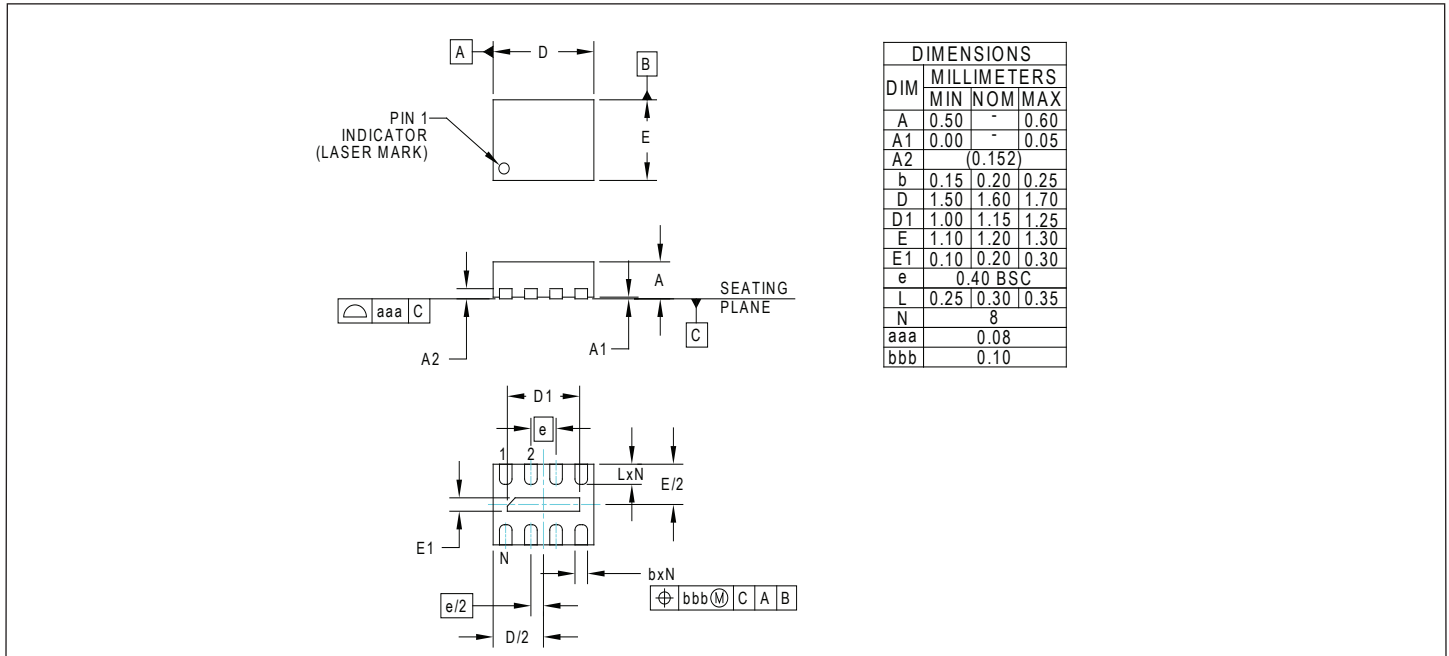

Figure 3 — SC563 Layout Example

Outline Drawing — MLPD-UT8 1.6X1.2



NOTES:

1. CONTROLLING DIMENSIONS ARE IN MILLIMETERS (ANGLES IN DEGREES).
2. COPLANARITY APPLIES TO THE EXPOSED PAD AS WELL AS THE TERMINALS.

Land Pattern — MLPD-UT8 1.6X1.2

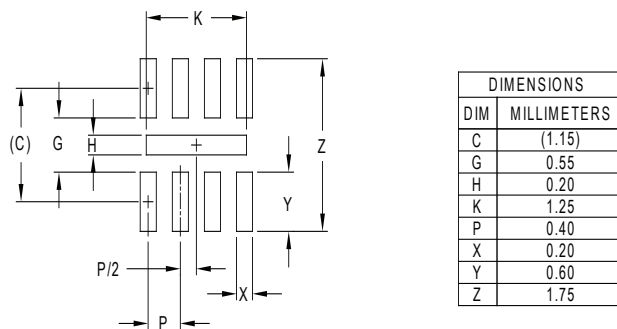

NOTES:

1. CONTROLLING DIMENSIONS ARE IN MILLIMETERS (ANGLES IN DEGREES).
2. THIS LAND PATTERN IS FOR REFERENCE PURPOSES ONLY. CONSULT YOUR MANUFACTURING GROUP TO ENSURE YOUR COMPANY'S MANUFACTURING GUIDELINES ARE MET.
3. THERMAL VIAS IN THE LAND PATTERN OF THE EXPOSED PAD SHALL BE CONNECTED TO A SYSTEM GROUND PLANE. FAILURE TO DO SO MAY COMPROMISE THE THERMAL AND/OR FUNCTIONAL PERFORMANCE OF THE DEVICE.



© Semtech 2015

All rights reserved. Reproduction in whole or in part is prohibited without the prior written consent of the copyright owner. The information presented in this document does not form part of any quotation or contract, is believed to be accurate and reliable and may be changed without notice. No liability will be accepted by the publisher for any consequence of its use. Publication thereof does not convey nor imply any license under patent or other industrial or intellectual property rights. Semtech assumes no responsibility or liability whatsoever for any failure or unexpected operation resulting from misuse, neglect improper installation, repair or improper handling or unusual physical or electrical stress including, but not limited to, exposure to parameters beyond the specified maximum ratings or operation outside the specified range.

SEMTECH PRODUCTS ARE NOT DESIGNED, INTENDED, AUTHORIZED OR WARRANTED TO BE SUITABLE FOR USE IN LIFE-SUPPORT APPLICATIONS, DEVICES OR SYSTEMS OR OTHER CRITICAL APPLICATIONS. INCLUSION OF SEMTECH PRODUCTS IN SUCH APPLICATIONS IS UNDERSTOOD TO BE UNDERTAKEN SOLELY AT THE CUSTOMER'S OWN RISK. Should a customer purchase or use Semtech products for any such unauthorized application, the customer shall indemnify and hold Semtech and its officers, employees, subsidiaries, affiliates, and distributors harmless against all claims, costs damages and attorney fees which could arise.

Contact Information

Semtech Corporation
Power Management Products Division
200 Flynn Road, Camarillo, CA 93012
Phone: (805) 498-2111 Fax: (805) 498-3804

www.semtech.com