

Relais statique biphasé de puissance Dual Power Solid State Relay

SOB942360

Output : 12-280VAC 2x25A
Input : 10-30VDC

- Relais statique biphasé synchrone spécialement adapté aux charges résistives.
Dual Zero Cross Solid State Relay especially designed for AC-51 resistive loads.
- Sortie 12 à 280VAC 2x25A.
Output 12 to 280VAC 2x25A.
- 1 seule entrée avec LED de visualisation de couleur verte.
1 inputs with green LED visualization.
- Différentes possibilités de connecteur de commande.
Les relais sont livrés sans le connecteur de commande.
Sélectionner ce connecteur pages 5 à 7.
Different possibilities for input connector.
Input connector is not delivered with the SSR.
Select input connector in pages 5 to 7.
- Protection IP20 par volets amovibles sur les bornes.
Etiquette repère disponible en option.
IP20 protection by removable flaps on terminals with optional labels.
- Construit en conformité aux normes IEC/EN60947-4-3 ; UL-cUL
Homologation S-Mark
Designed in conformity with IEC/ EN60947-4-3 ; UL-cUL
S-mark certification



Livré sans connecteur de commande
Delivered without input connector



Avec étiquette de repérage en option
With optional labels

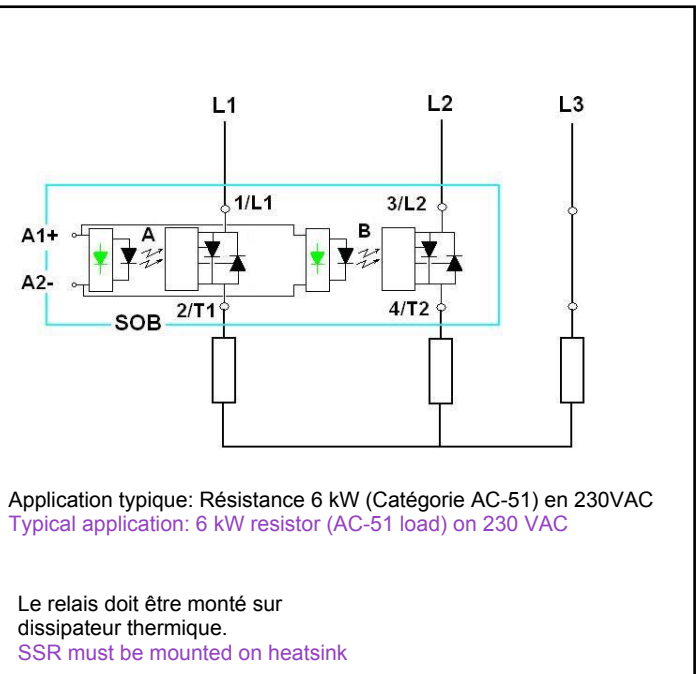
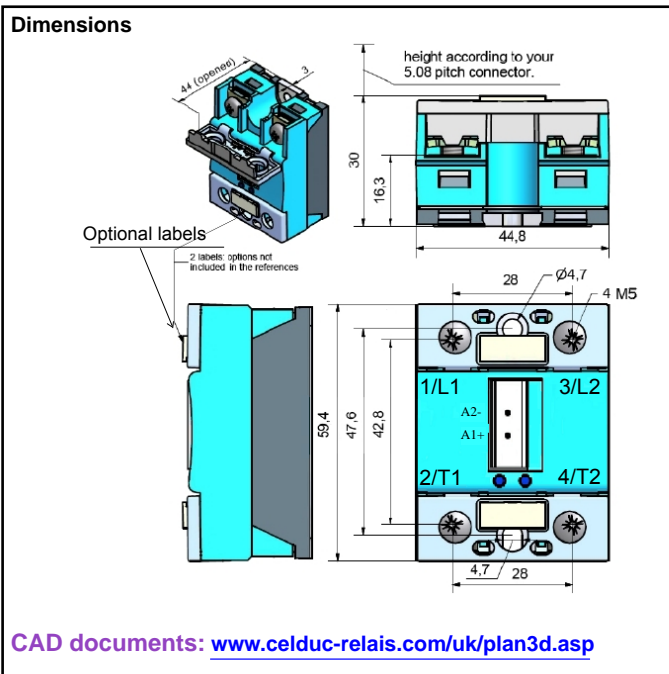

Proud to serve you

celduc®

r e l a i s

Input : $I_c = f(U_c)$ **Caractéristiques d'entrée / Control characteristics (at 25°C)**

Paramètre / Parameter	Symbol	DC			Unit
		Min	Typ	Max	
Tension de commande / Control voltage	U_c	10		30	V
Courant de commande / Control current (@ U_c)	I_c	12		52	mA
Tension de non fonctionnement / Release voltage	$U_{c\ off}$	2			V
LED d'entrée / Input LED		verte / green			
Tension Inverse / Reverse voltage	U_{rv}		32		V
Immunité / Input immunity : EN61000-4-4			2kV		
Immunité / Input immunity : EN61000-4-5			2KV		

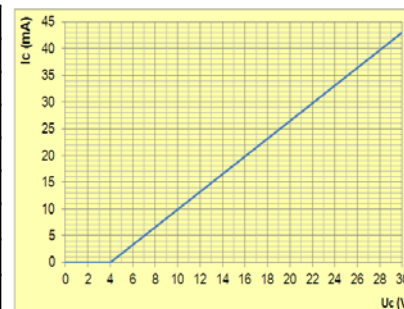
**Caractéristiques de sortie / Output characteristics (at 25°C)**

par voie/ for each output

Paramètre / Parameter	Conditions	Symbol	Min	Typ.	Max	Unit
Plage de tension utilisation / Operating voltage range		U_e	12	230	280	V rms
Tension de crête / Peak voltage (clamping voltage)		U_p	600			V
Niveau de synchronisme / Zero cross level		U_{sync}			35	V
Tension minimum amorçage / Latching voltage	le nom	U_a	10			V
Courant nominal / nominal current (AC-51)	Heater	$I_{e\ AC-51}$		25	25	A rms
Courant surcharge / Non repetitive overload current	$t_p=10ms$ (Fig. 3)	I_{tsm}	260	340		A
Chute directe à l'état passant / On state voltage drop	($I_e =$ nominal current)	V		$0.85 + 0,016xI_e$		V
Tension seuil à l'état passant / On state Threshold voltage	@ 25°C	V_{to}			0.85	V
Résistance dynamique / On state dynamic resistance		r_t			16	mΩ
Puissance dissipée (max) / Output power dissipation (max value)		P_d	$0.765xI_e + 0,016xI_e^2$			W
Résistance thermique jonction/semelle / Thermal resistance between junction to case		$R_{thj/c}$			0.9	K/W
Courant de fuite à l'état bloqué / Off state leakage current	@ U_e typ, 50Hz	I_{lk}			1	mA
Courant minimum de charge / Minimum load current		I_{emin}	5			mA
Temps de fermeture / Turn on time	@ U_e typ, 50Hz	$t_{on\ max}$			10	ms
Temps d'ouverture / Turn off time	@ U_e typ, 50Hz	$t_{off\ max}$			10	ms
Fréquence réseau / Mains frequency range	F mains	f	0,1	50-60	800	Hz
dv/dt à l'état bloqué / Off state dv/dt		dv/dt	500			V/μs
di/dt max / Maximum di/dt non repetitive		di/dt			50	A/μs
I^2t (<10ms) : Value for fusing		I^2t	340	600		A ² s
Immunité / Conducted immunity level	IEC/EN61000-4-4 (bursts)		2kV criterion B			
Immunité / Conducted immunity level	IEC/EN61000-4-5 (surge)		2kV criterion B			
Protection court-circuit / Short circuit protection	voir/see page 5	Example	Fuse FERRAZ gRC 25A 14x51			

Caractéristiques générales / General characteristics (at 25°C)

Isolement entrée/sortie - Input to output insulation	U_i	4000	VRMS
Isolation sortie/ semelle - Output to case insulation	U_i	2500	VRMS
Résistance Isolement / Insulation resistance	R_i	1000 (@500VDC)	MΩ
Tenue aux tensions de chocs / Rated impulse voltage	U_{imp}	4000	V
Degré de protection / Protection level / CEI529		IP20	
Degré de pollution / Pollution degree	-	2	
Vibrations / Vibration withstand 10 -150 Hz according to IEC 60068-2-6	sine test	10	g
Tenue aux chocs / Shocks withstand according to IEC 60068-2-27	11ms	> 30 50	g
Température de fonctionnement / Ambient temperature (no icing, no condensation)	-	-55 /+100	°C
Température de stockage/ Storage temperature (no icing, no condensation)		-55/+125	°C
Humidité relative / Ambient humidity	HR	40 to 85	%
Poids/ Weight		80	g
Conformité CE / CE Conformity		IEC/ EN60947-4-3	
Conformité USA / US Conformity		UL/cUL	
Conformité normes ferroviaires/ Conformity to railways applications		yes (consult us)	
Plastique du boîtier / Housing Material		PA 6 UL94VO	
Semelle / Base plate		Aluminium, Tinned-plated	



celduc®
relais

www.celduc.com

5, Rue Ampère BP30004 42290 SORBIERS - FRANCE E-mail : celduc-relais@celduc.com
 Fax +33 (0) 4 77 53 85 51 Service Commercial France Tél. : +33 (0) 4 77 53 90 20
 Sales Dept.For Europe Tel. : +33 (0) 4 77 53 90 21 Sales Dept. Asia : Tél. +33 (0) 4 77 53 90 19

Fig. 2 Courbes thermiques & Choix dissipateur thermique / Thermal curves and heatsink choice

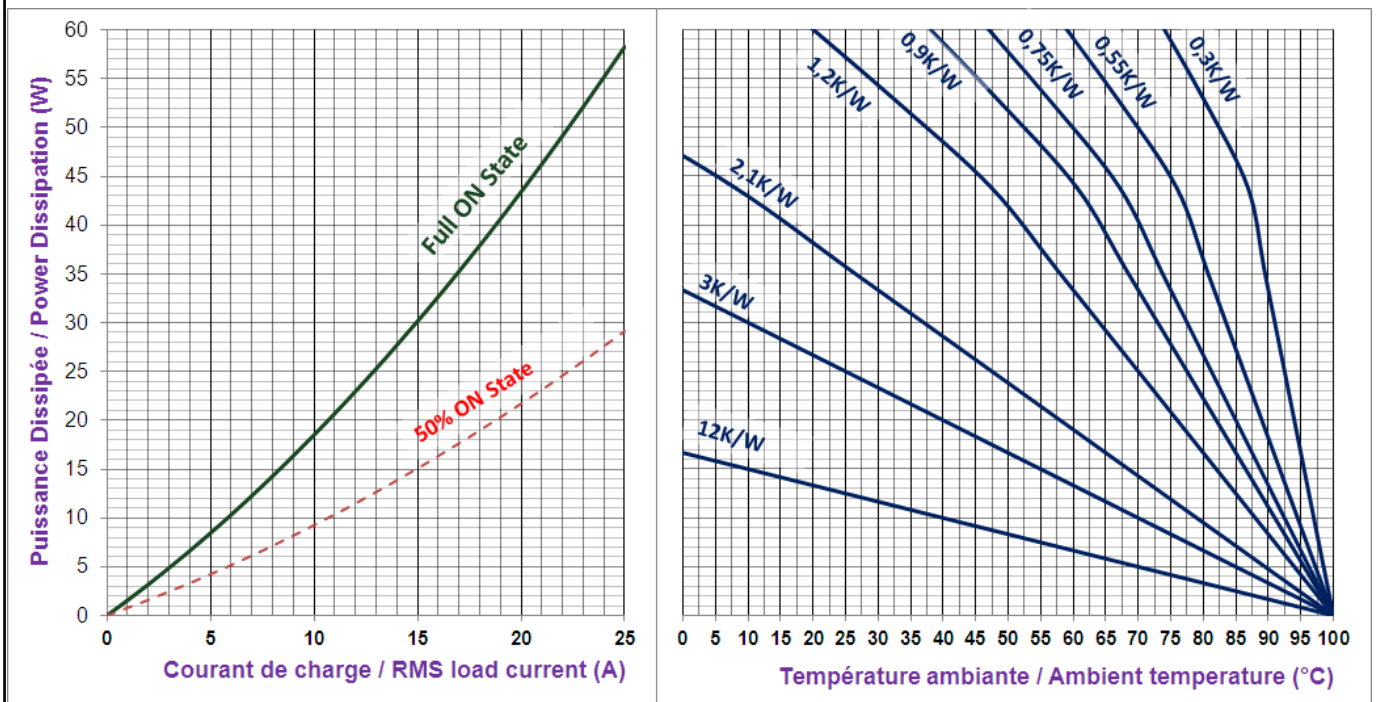

Dissipateurs **celduc** standard/ Standard **celduc** heatsinks:

- 6K/W correspond à un relais monté sur un adaptateur DIN **celduc** type 1LD12020
- 6K/W corresponds to a relay mounted on a DIN rail adapter like **celduc** 1LD12020
- WF210000/ WF151200 = 2.1- 2.2K/W
- WF121000 /WF108110 =1.1-1.2K/W
- WF070000 = 0.75K/W
- WF050000 = 0.55K/W

- WF115100 = 0.9K/W
- WF031x = 0.3K/W

fig 3 : Courants de surcharges / Overload currents

- 1 - **Its_m non répétitif** sans tension réappliquée est donné pour la détermination des protections.
1 - **No repetitive Its_m** is given without voltage reappplied.
This curve is used to define the protection (fuses).
- 2 - **Its_m répétitif** est donné pour des surcharges de courant (T_j initiale=70°C).
Attention : la répétition de ces surcharges de courant diminue la durée de vie du relais.
- 2 - **Repetitive Its_m** is given for inrush current with initial T_j = 70°C. In normal operation, this curve musn't be exceeded.
Caution, frequent over load currents will decrease the life expectancy of the SSR.

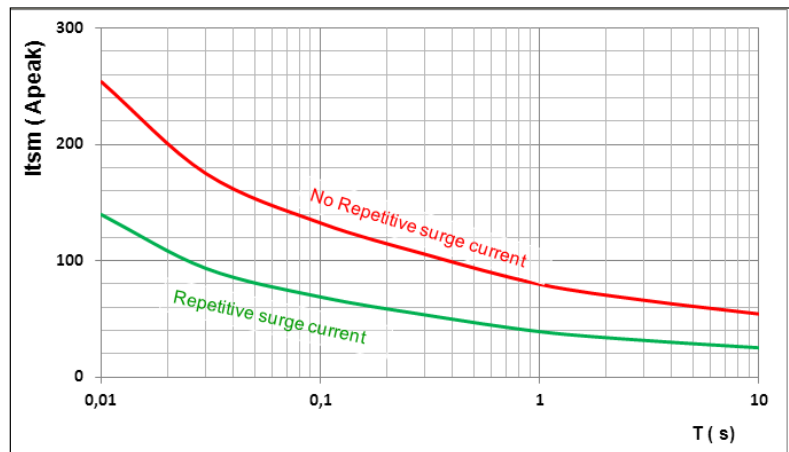

→ Attention ! les relais à semi-conducteurs ne procurent pas d'isolation galvanique entre le réseau et la charge. Ils doivent être utilisés associés à un disjoncteur avec propriété de sectionnement ou similaire, afin d'assurer un sectionnement fiable en amont de la ligne dans l'hypothèse d'une défaillance et pour tous les cas où le relais doit être isolé du réseau (maintenance; non utilisation sur une longue durée...).





Sous réserve d'installation, d'entretien et d'utilisation conformes à sa destination, à la réglementation, aux normes en vigueur, aux instructions du constructeur et aux règles de l'art.

→ Warning ! semiconductor relays don't provide any galvanic insulation between the load and the mains. Always use in conjunction with an adapted circuit breaker with insulation feature or a similar device in order to ensure a reliable insulation in the event of wrong function and when the relay must be insulated from the mains (maintenance ; if not used for a long duration ...).

It is important that the solid state relay is subject to correct installation, maintenance and use conforming to its intended regulations and standards, to the supplier's instructions and to accepted rules of art.

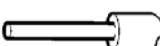
Raccordement / Connections

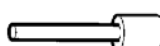
okpac®	Raccordement de commande / Control wiring
Voir page 5 à 7 / See page 5 to 7	

okpac®				Raccordement de puissance / Power wiring	
Nombre de fils / Number of wires				Modèle de tournevis / Screwdriver type	Couple de serrage recommandé Vis M5 Recommended Tightening Torque M5 screw N.m
1		2			
Fil rigide (sans embout) SOLID (No ferrule)	Fil multibrins (avec embout) FINE STRANDED (With ferrule)	Fil rigide (sans embout) SOLID (No ferrule)	Fil multibrins (avec embout) FINE STRANDED (With ferrule)		Mini 2 / Typ 2.4 / Max 3
					
1,5 ... 10 mm ² AWG16....AWG8	1,5 ... 6 mm ² AWG16....AWG10	1,5 ... 10 mm ² AWG16....AWG8	1,5 ... 6 mm ² AWG16....AWG10	POZIDRIV 2	

Directement avec fils avec ou sans embouts/
Direct connection with wires with or without ferrules



Avec cosses/
With ring terminals



<p>Puissance avec cosses / Power with ring terminals.</p> <p>W max =12,6mm</p> <p>16 mm² (AWG6) 25 mm² (AWG4) 35mm² (AWG2 /AWG3) 50mm² (AWG0 /AWG1)</p> <p>Des cosses et kits d'adaptation peuvent être fournis : voir relais forte puissance et documentation connexion forte puissance/ Suitable ring terminals and special kit for high current can be delivered: see high power SSR and data-sheet for power connection.</p>	<p>Volets IP20 / IP20 flaps Les volets sont maintenant montés en standard en usine Flaps are delivered mounted on the relay.</p> <p>Étiquettes/ Labels: Des étiquettes de repérage sont aussi disponibles. Quantités par 200 pièces Montage sur volets (1MZ09000). Marking labels are available, for mounting on flaps. Part number : 1MZ09000 (delivered per 200 parts)</p> <p>FASTONS : Nous consulter / Consult us</p>	     
---	---	---



Connecteur à vis
Screw solution

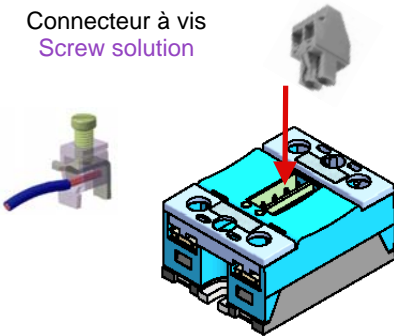

Raccordement de commande par connecteur débrochable /
Control connections by pluggable connector

Différentes possibilités de connecteurs et de sorties /
Different possibilities of connectors and outputs

<p>1 vis / screw 270°</p> <p>Ref : 1Y022715 Weidmuller: BLZ5,08/2/270SN SW</p> <p>1 fil / Single wire = 0,15...2,5mm² (26-12AWG) Dénudage / Wire strip length=7mm</p>	<p>2 vis / screw 90°</p> <p>Ref : 1Y020915 Weidmuller: BLZ5,08/2/90SN SW</p> <p>1 fil / Single wire = 0,15...2,5mm² (26-12AWG) Dénudage / Wire strip length=7mm</p>
<p>3 vis / screw 45°</p> <p>Ref : 1Y022217 Weidmuller: BLZ5,08/2/225SN SW</p> <p>1 fil / Single wire = 0,15...2,5mm² (26-12AWG) Dénudage / Wire strip length =8mm</p>	<p>4 double</p> <p>Ref : 1Y021660 Weidmuller: BLDT5,08/2 SN SW</p> <p>1 fil / Single wire = 0,15...2,5mm² (26-12AWG) Dénudage / Wire strip length=7mm</p>

CAD documents : www.celduc-relais.com/uk/plan3d.asp



celduc®
relais

www.celduc.com

5 Rue Ampère B.P. 3004 42290 SORBIERS - FRANCE E-Mail : celduc-relais@celduc.com
 Fax +33 (0) 4 77 53 85 51 Service Commercial France Tél. : +33 (0) 4 77 53 90 20
 Sales Dept.For Europe Tel. : +33 (0) 4 77 53 90 21 Sales Dept. Asia : Tél. +33 (0) 4 77 53 90 19

Raccordement de commande par connecteur débrochable / Control connections by pluggable connector

Différentes possibilités de connecteurs et de sortie/ Different possibilities of connectors and outputs

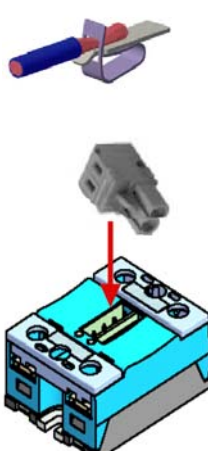
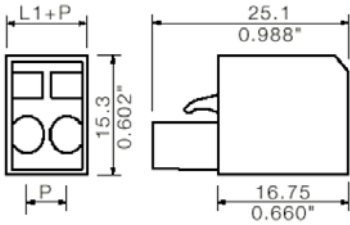
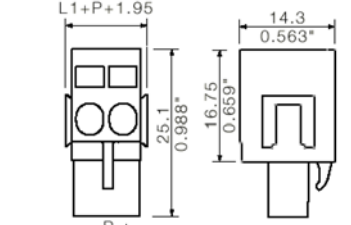
<p>Solution ressort Spring solutions</p>  <p>5</p> 	<p>5 180°</p> <p>Ref : <u>1Y021817</u> Weidmuller: BLZF5,08/2/180 SW</p>  <p>1 fil / Single wire = 0,15...2,5mm² (26-12AWG) Dénudage / Wire strip length = 10mm</p> 	<p>6 270°</p> <p>Ref : <u>1Y022716</u> Weidmuller: BLZF5,08/2/270 SW</p>  <p>1 fil / Single wire = 0,15...2,5mm² (26-12AWG) Dénudage / Wire strip length = 10mm</p> 	<p>7 90°</p> <p>Ref : <u>1Y020916</u> Weidmuller: BLZF5,08/2/90 SW</p>  <p>1 fil / Single wire = 0,15...2,5mm² (26-12AWG) Dénudage / Wire strip length = 10mm</p> 
<p>6</p>  <p>7</p>  <p>8</p>  <p>Sans outil / no tool</p>	<p>8 Solution à ressort sans outil Spring solutions with no tool</p> <p>Ref : <u>1Y024604</u> RIA: ASO02604.02</p>   <p>Insérer et retirer un fil / Put and remove a wire</p>  <p>1 fil diamètre/ Single wire diameter = 0,3...1,3mm (28-16AWG) Dénudage / Wire strip length = 4mm</p>		

CAD documents : www.celduc-relais.com/uk/plan3d.asp



celduc®
relais

www.celduc.com

5 Rue Ampère B.P. 30004 42290 SORBIERS - FRANCE E-Mail : celduc-relais@celduc.com
 Fax +33 (0) 4 77 53 85 51 Service Commercial France Tél. : +33 (0) 4 77 53 90 20
 Sales Dept. For Europe Tel. : +33 (0) 4 77 53 90 21 Sales Dept. Asia : Tél. +33 (0) 4 77 53 90 19

Raccordement de commande par connecteur débrochable / Control connections by pluggable connector

Différentes possibilités de connecteurs et de sortie / Different possibilities of connectors and outputs

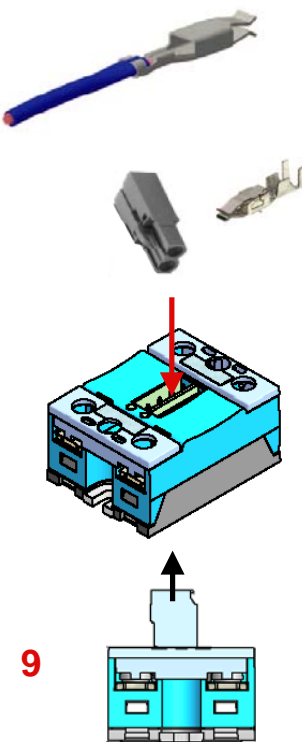
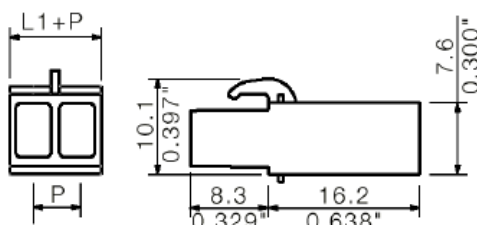
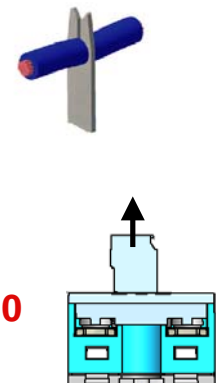
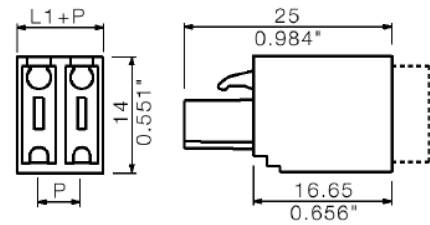
<p>Cosses Crimp solutions</p>  <p>9</p>	<p>9 Cosses / Crimp solutions</p> <p>Ref : 1Y021711 Weidmuller: BLC5,08/2/180R SW</p> <p>Ref : 1Y011567 Weidmuller: CTS FemBLAC 0,5/1mm² 1267060000 (Single Contacts 20-17AWG)</p> <p>- Autres tailles / Other sizes : 0,22 à/to 2,5mm² (nous consulter) 14-24 AWG (consult us) - Dénudage / Stripping length = 5mm</p>  <p>Process automatique (bandes) : nous consulter / Automatic process (band) : consult us</p>
<p>Connexion à déplacement d'isolant / Insulation Displacement Connection</p>  <p>10</p>	<p>10</p> <p>Nous consulter / Consult us</p> 

CAD documents : www.celduc-relais.com/uk/plan3d.asp

Montage / Mounting:

- > Les relais statiques de la gamme okpac® doivent être montés sur dissipateur thermique. Une gamme étendue de dissipateurs est disponible. Voir exemples ci dessous et la gamme "WF" sur www.celduc.com.
okpac® SSRs must be mounted on heatsinks. A large range of heatsinks is available. See below some examples and "WF" range on www.celduc.com.
- > Pour le montage du relais sur dissipateur utiliser de la graisse thermique ou un "thermal pad" haute performance spécifié par **celduc®**. Une version autocollante précollée sur le relais (5TH23000) est aussi disponible: nous consulter
For heatsink mounting, it is necessary to use thermal grease or thermal pad with high conductivity specified by **celduc®**.
An adhesive model (5TH23000) mounted by **celduc®** on the SSR is also available: please contact us.

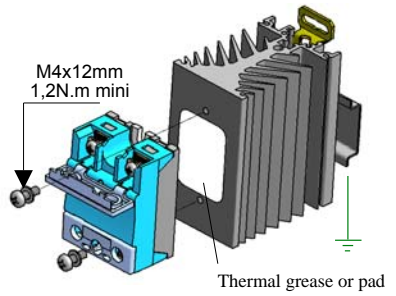
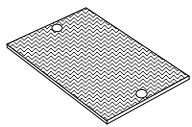
**Thermal pads :**

5TH21000

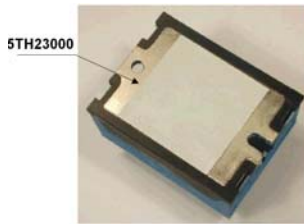
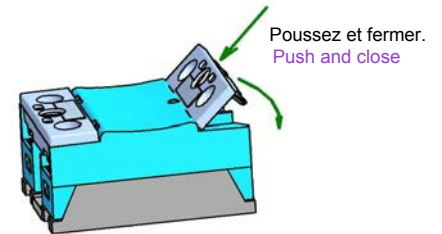
1LD12020
Adaptateur DIN
DIN rail adaptorUtilisation des volets IP20
IP20 flaps using**Heatsinks :**WF151200
(2-2,5 K/W)WF108110
(1.2 K/W)WF115100
(0.9K/W)WF031x
(0.3 K/W)**Application typique / Typical LOAD**

- > Les produit SOB9 sont définis principalement pour charge résistive AC-51 (chauffage).
SOB9 products are specially designed for AC-51 resistive load (heating).

Protection / Protection :

- > La protection d'un relais statique contre les court-circuits de la charge peut être faite par fusibles rapides avec des I2t = 1/2 I2t du relais . Un test en laboratoire a été effectué sur les fusibles de marque FERRAZ. Une protection par MCB (disjoncteurs modulaires miniatures) est aussi possible. Voir notre note application (protection SSR) et utiliser des relais avec I2t >5000A2s
To protect the SSR against a short-circuit of the load , use a fuse with a I2t value = 1/2 I2t value specified page 2.
A test has been made with FERRAZ fuses .
It is possible to protect SSR by MCB (miniature circuit breaker).
In this case, see application note (SSR protection) and use a SSR with high I2t value (5000A2s minimum).



celduc®
relais

www.celduc.com

5, Rue Ampère BP30004 42290 SORBIERS - FRANCE E-mail : celduc-relais@celduc.com
Fax +33 (0) 4 77 53 85 51 Service Commercial France Tél. : +33 (0) 4 77 53 90 20
Sales Dept.For Europe Tel. : +33 (0) 4 77 53 90 21 Sales Dept. Asia : Tél. +33 (0) 4 77 53 90 19

CEM / EMC :

-> Immunité : Nous spécifions dans nos notices le niveau d'immunité de nos produits selon les normes essentielles pour ce type de produit, c'est à dire EN61000-4-4 &5.

Immunity : We give in our data-sheets the immunity level of our SSRs according to the main standards for these products: EN61000-4-4 &5.

-> Emission: Nos relais statiques sont principalement conçus et conformes pour la classe d'appareils A (Industrie).

L'utilisation du produit dans des environnements domestiques peut amener l'utilisateur à employer des moyens d'atténuation supplémentaires. En effet, les relais statiques sont des dispositifs complexes qui doivent être interconnectés avec d'autres matériels (charges, cables, etc) pour former un système. Etant donné que les autres matériels ou interconnexions ne sont pas de la responsabilité de celduc®, il est de la responsabilité du réalisateur du système de s'assurer que les systèmes contenant des relais statiques satisfont aux prescriptions de toutes les règles et règlements applicables au niveau des systèmes.

Consulter celduc® qui peut vous conseiller ou réaliser des essais dans son laboratoire sur votre application.

Emission: celduc® SSRs are mainly designed in compliance with standards for class A equipment (Industry).

Use of this product in domestic environments may cause radio interference. In this case the user may be required to employ additional devices to reduce noise. SSRs are complex devices that must be interconnected with other equipment (loads, cables, etc.) to form a system. Because the other equipment or the interconnections may not be under the control of celduc®, it shall be the responsibility of the system integrator to ensure that systems containing SSRs comply with the requirement of any rules and regulations applicable at the system level.

Consult celduc® for advices. Tests can be performed in our laboratory.

**celduc®**
r e l a i swww.celduc.com

5, Rue Ampère BP30004 42290 SORBIERS - FRANCE E-mail : celduc-relais@celduc.com
Fax +33 (0) 4 77 53 85 51 Service Commercial France Tél. : +33 (0) 4 77 53 90 20
Sales Dept.For Europe Tel. : +33 (0) 4 77 53 90 21 Sales Dept. Asia : Tél. +33 (0) 4 77 53 90 19