

SF2204E

**1900 MHz
SAW Filter**

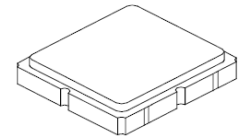

SM3030-6

- **Low-loss SAW Filter**
- **Surface-mount 3.0 x 3.0 x 1.4 mm Package**
- **Complies with Directive 2002/95/EC (RoHS)**
- **Moisture Sensitivity Level: 1**

Absolute Maximum Ratings

Rating	Value	Units
Input Power Level	10	dBm
DC Voltage on any Non-ground Terminal	3	V
Operating Temperature Range	-20 to +70	°C
Storage Temperature Range in Tape and Reel	-40 to +85	°C
Solder Reflow Temperature, 10 seconds, 5 cycles maximum	260	°C

Electrical Characteristics

Characteristic	Sym	Notes	Min	Typ	Max	Units
Center Frequency	F_C			1900		MHz
Insertion Loss, 1880 to 1920 MHz	IL			2.7	3.5	dB
Amplitude Ripple, 1880 to 1920 MHz				1.0	1.5	dB _{P-P}
Group Delay Ripple, 1880 to 1920 MHz				10	40	ns _{P-P}
Input VSWR, 1880 to 1920 MHz				1.5:1	2.0:1	
Output VSWR, 1880 to 1920 MHz				1.5:1	2.0:1	
Attenuation Referenced to 0 dB						
0.3 to 1000 MHz			30	35		dB
1000 to 1700 MHz			30	35		
1700 to 1830 MHz			32	38		
1970 to 2400 MHz			38	45		
2400 to 3000 MHz			30	40		
3000 to 4000 MHz			25	34		
Source Impedance	Z_S			50		Ω
Load Impedance	Z_L			50		

Case Style	SM3030-6 3.0 x 3.0 mm Nominal Footprint					
Lid Symbolization (Y=year, WW=week, S=shift) dot=pin 1 indicator	936, <u>YWWS</u>					
Standard Reel Quantity	Reel Size 7 Inch					500 Pieces/Reel
	Reel Size 13 Inch					3000 Pieces/Reel

Electrical Connections

Connection	Terminals
Input	5
Output	2
Ground	All Others

 **CAUTION: Electrostatic Sensitive Device. Observe precautions for handling.**
NOTES:

1. The design, manufacturing process, and specifications of this device are subject to change.
2. US or International patents may apply.
3. RoHS compliant from the first date of manufacture.

Filter Passband Response, 1800 to 2000 MHz

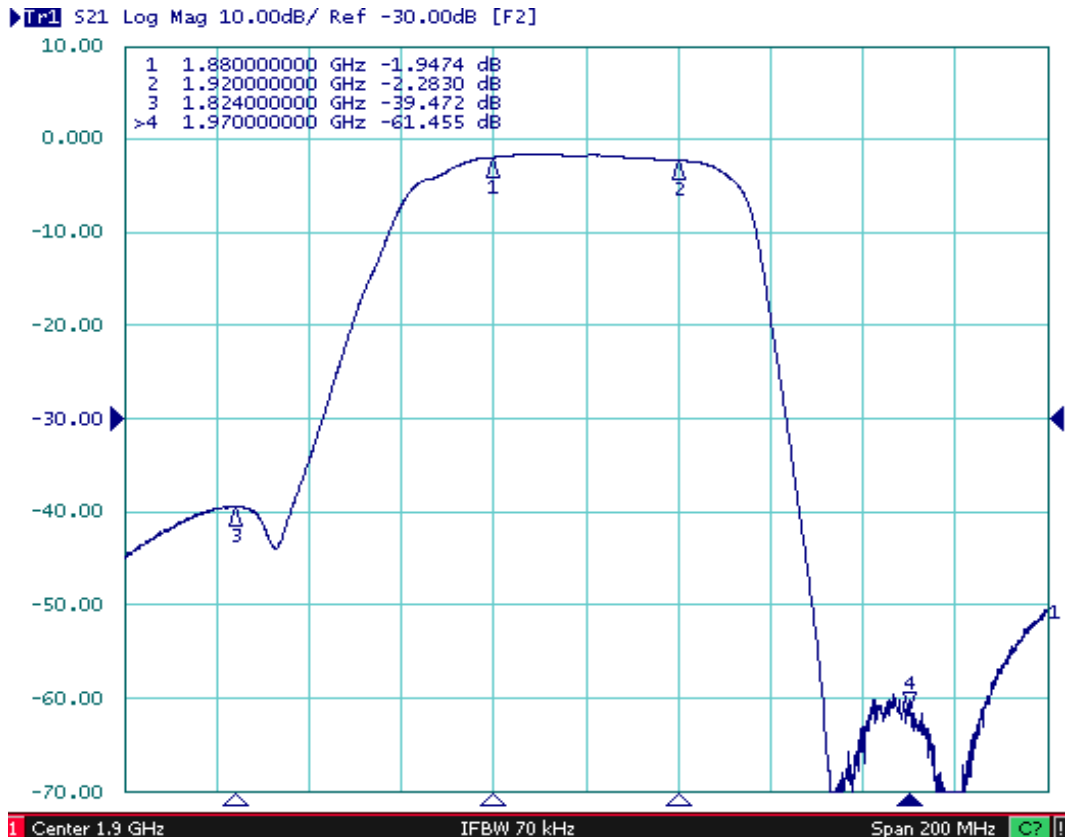

Filter Test Circuit

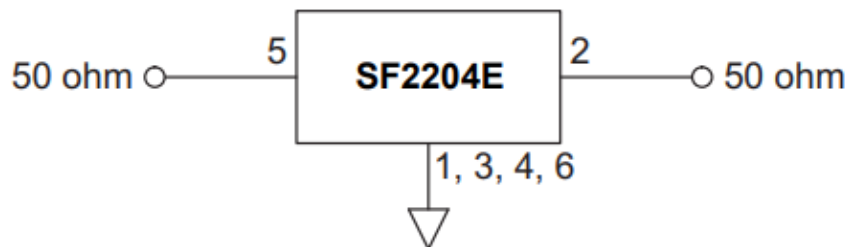

Filter Broadband Response, 300 kHz to 4000 MHz

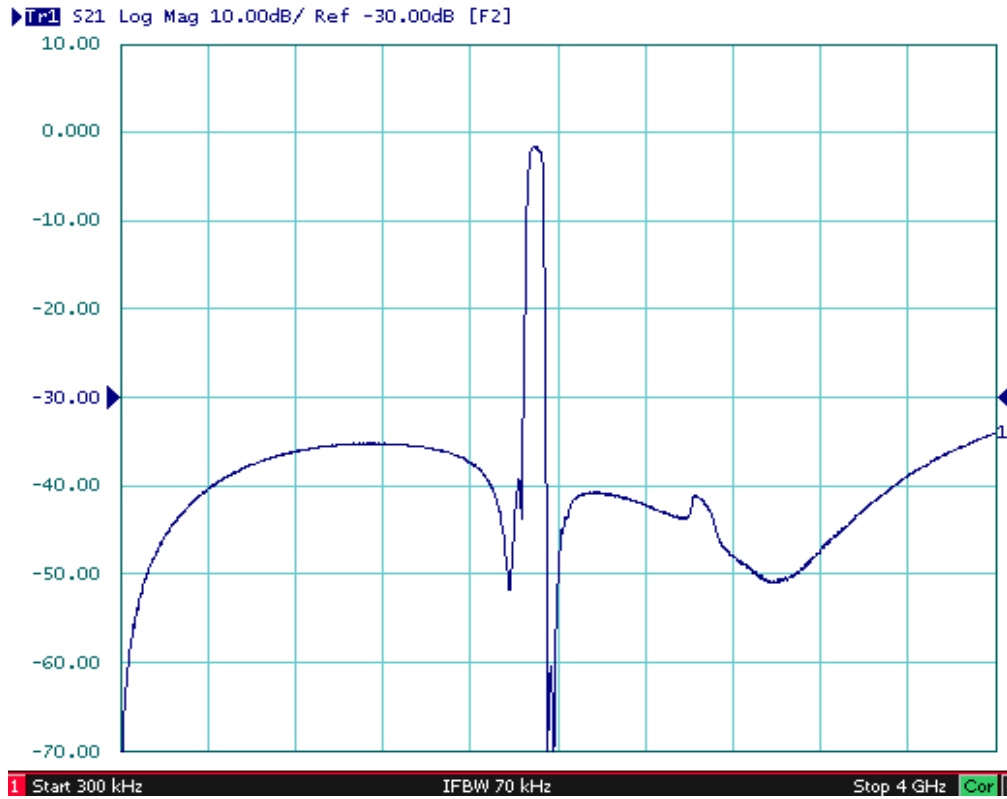

Filter Group Delay Plot, 1800 to 2000 MHz

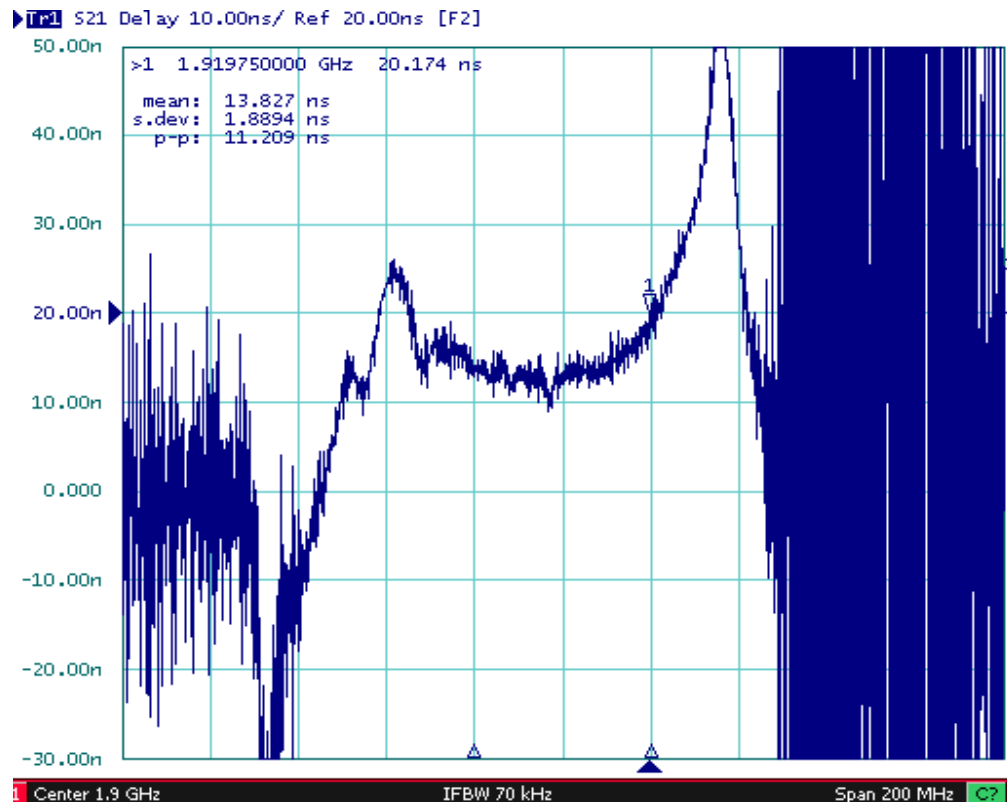

Input and Output VSWR Plots

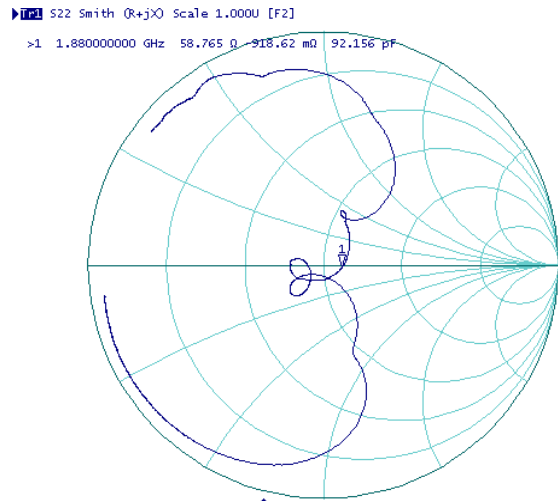
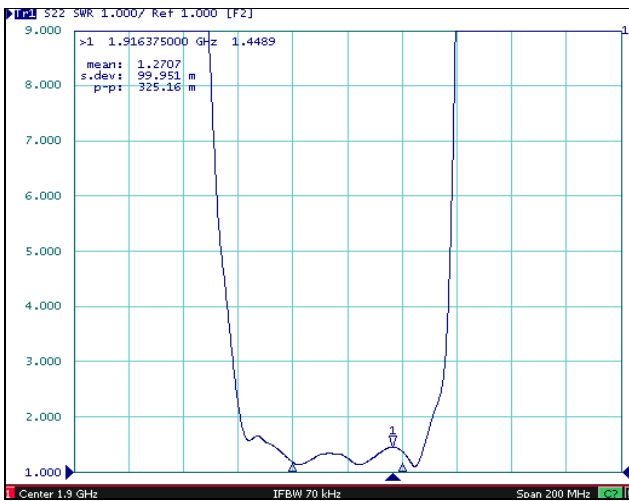
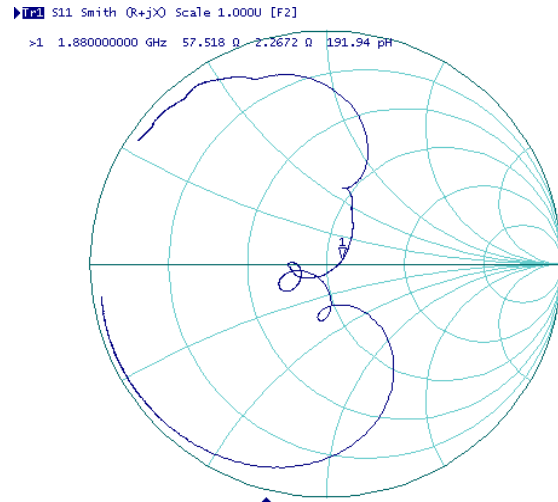

SM3030-6 Case

6-Terminal Ceramic Surface-Mount Case 3.0 X 3.0 mm Nominal Footprint

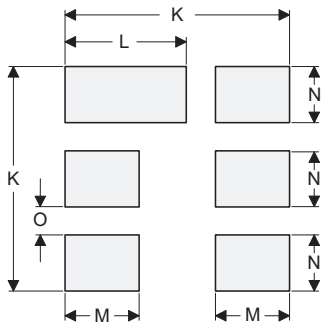
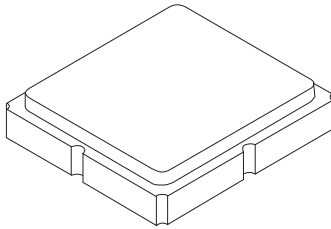

PCB Footprint Top View

Case and PCB Footprint Dimensions

Dimension	mm			Inches		
	Min	Nom	Max	Min	Nom	Max
A	2.87	3.00	3.13	0.113	0.118	0.123
B	2.87	3.00	3.13	0.113	0.118	0.123
C	1.12	1.25	1.38	0.044	0.049	0.054
D	0.77	0.90	1.03	0.030	0.035	0.040
E	2.67	2.80	2.93	0.105	0.110	0.115
F	1.47	1.60	1.73	0.058	0.063	0.068
G	0.72	0.85	0.98	0.028	0.033	0.038
H	1.37	1.50	1.63	0.054	0.059	0.064
I	0.47	0.60	0.73	0.019	0.024	0.029
J	1.17	1.30	1.43	0.046	0.051	0.056
K		3.20			0.126	
L		1.70			0.067	
M		1.05			0.041	
N		0.81			0.032	
O		0.38			0.015	

Case Materials

Materials	
Solder Pad Plating	0.3 to 1.0 μ m Gold over 1.27 to 8.89 μ m Nickel
Lid Plating	2.0 to 3.0 μ m Nickel
Body	Al ₂ O ₃ Ceramic

TOP VIEW

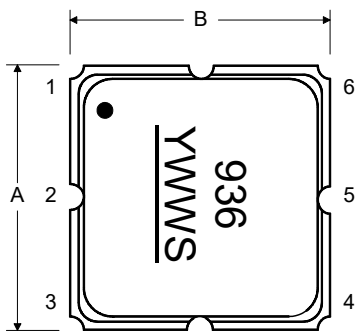

BOTTOM VIEW

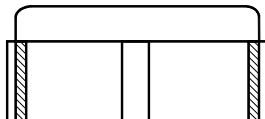
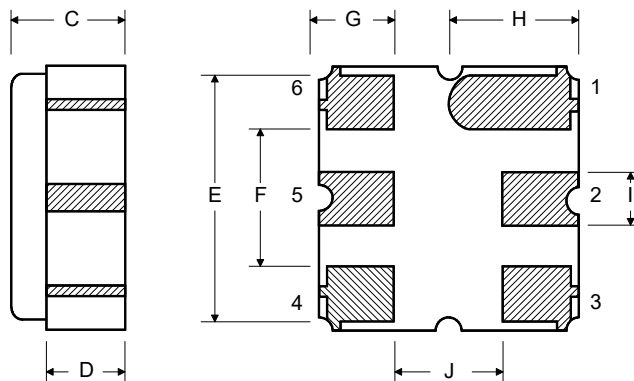

Tape and Reel Specifications

Tape and Reel Standard per ANSI/EIA481

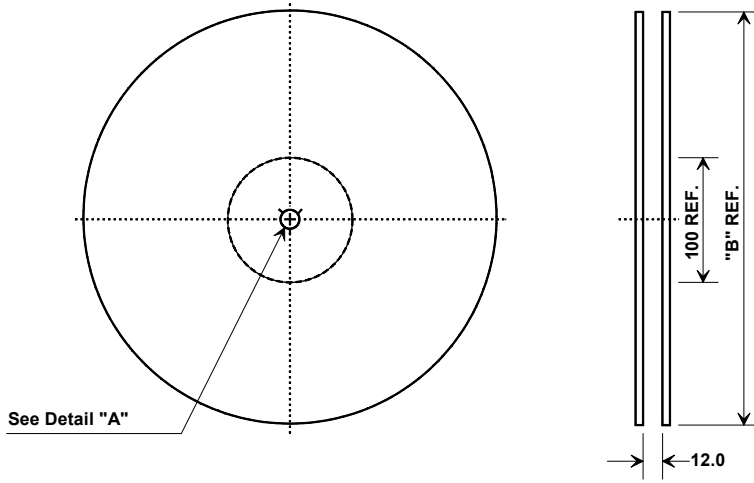

"B"		Quantity Per Reel
Inches	millimeters	
7	178	500
13	330	3000

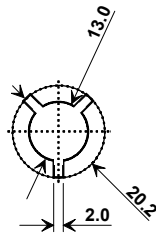

COMPONENT ORIENTATION and DIMENSIONS

Carrier Tape Dimensions	
Ao	3.35 mm
Bo	3.35 mm
Ko	1.40 mm
Pitch	8.0 mm
W	12.0 mm

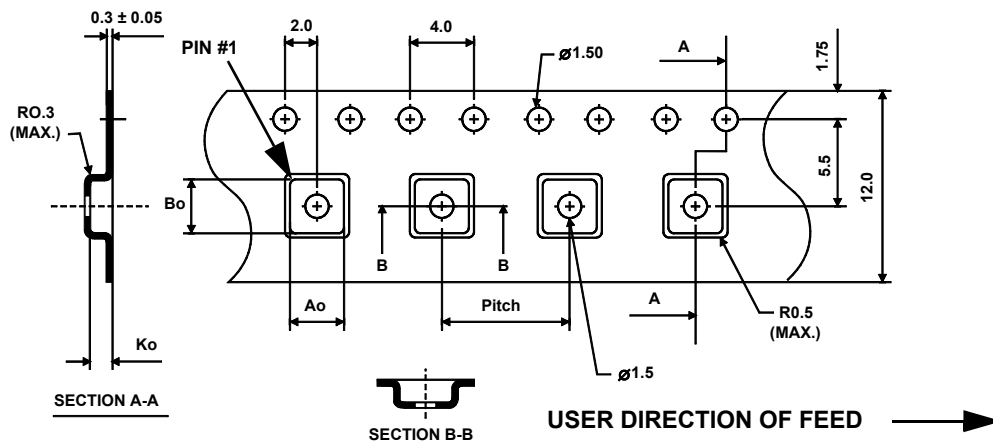

Recommended Reflow Profile

1. Preheating shall be fixed at 150~180° for 60~90 seconds.
2. Ascending time to preheating temperature 150° shall be 30 seconds min.
3. Heating shall be fixed at 220°C for 50~80 seconds and at 260°C peak (10 seconds.)
4. Time: 5 times maximum

