

Data sheet | Item number: 757-403/000-005
M8 sensor/actuator box; 10-way; 3-pole; 5 m

www.wago.com/757-403/000-005

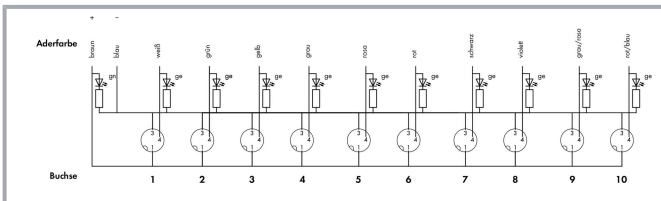
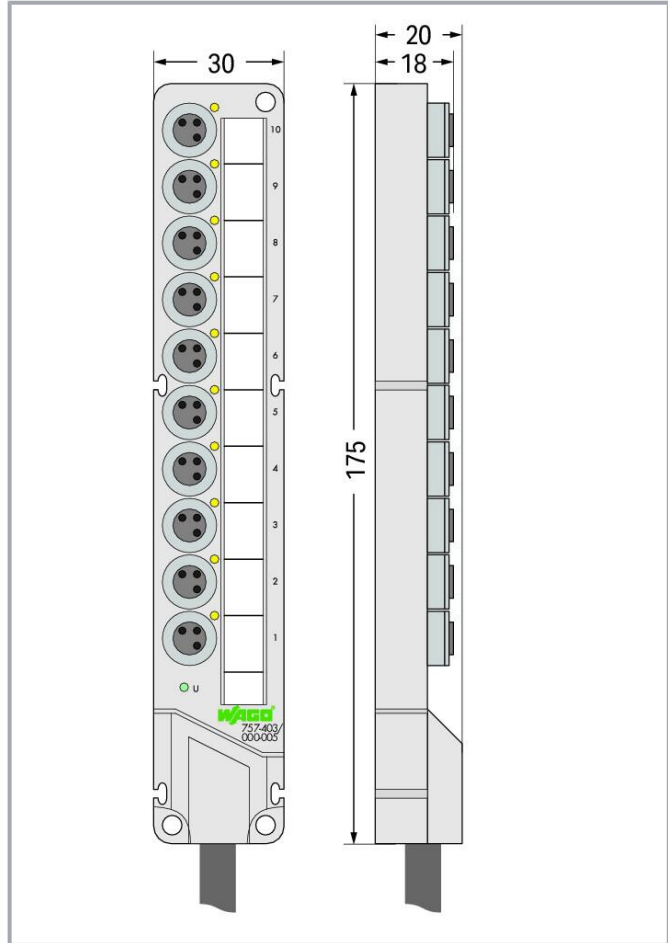

Subject to changes. Please also observe the further product documentation!

WAGO GmbH & Co. KG
Hansastr. 27
32423 Minden
Phone: +49571 887-0 | Fax: +49571 887-169
Email: info.de@wago.com | Web: www.wago.com

Do you have any questions about our products?
We are always happy to take your call at +49 (571) 887-44222.

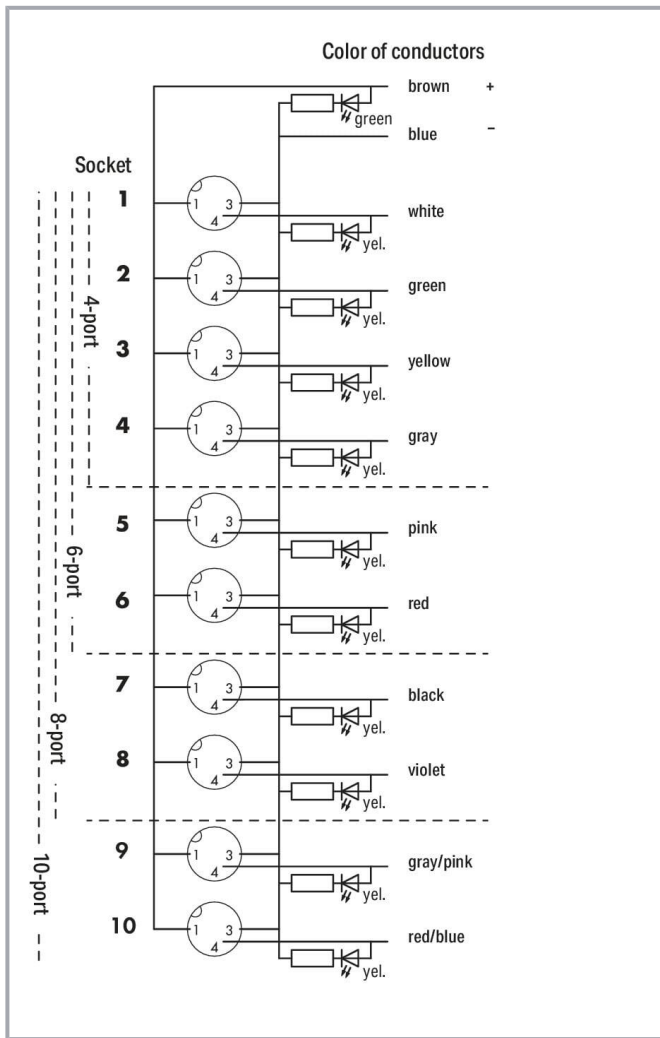

Item description

- M8 sensor/actuator box, 10-way
- 3-pole (1 signal per contact)
- Cable length: 5 and 10 m
- Green LED operating indicator
- Yellow LED status indicator
- incl. marking strips (WMB markers can also be used)
- incl. M8 protective caps (2 pcs)

Subject to changes. Please also observe the further product documentation!

Data

Technical data

Contact resistance (max.)	0.01 Ω
Supply voltage	10 ... 30 VDC; Rated voltage: 32 V ~ rms
Current carrying capacity (signal connections)	2 A
Current carrying capacity (supply connections)	6 A
Rated value of electrical isolation	500 V
Functionally separated potential groups	Kontakt/Kontakt
Insulation resistance	1000 M Ω
Signal characteristics	PNP
Indicators	LED yellow: Signal status (1 x per contact); LED (U) green: Sensor /actuator box status

Connection data

Connection technology: inputs/outputs	10 x M8 socket; 3-pole
Connection technology: trunk cable	1 x Fixed connecting cable
Length of connection cable	5 m
Strip length	100 mm / 3.94 inches
Wire colors	white, green, yellow, gray, pink, red, black, purple, gray/pink, red /blue, brown, blue
Cable design	Wire cross-section: 0.34 mm ² ; Wire cross-section (2): 0.75 mm ²

Physical data

Width	30 mm / 1.181 inches
Height	20 mm / 0.787 inches
Depth	175 mm / 6.89 inches

Mechanical Data

Mounting type	Screw mounting
Weight	570 g

Material Data

Housing material	PA 66 (UL 94 V0); RAL 7035; silicon and halogen free
Halogen-free	Yes
Sheathed cable diameter	7.6 mm

Subject to changes. Please also observe the further product documentation!



Bending radius	10 x cable diameter (min.) for flexible application
Material properties of the connections	Contact: CuSn, nickel base-coat plating and 0.8 µm gold-plated; Threaded bush: die-cast Zn, nickel-plated; Seal: Viton; 50 mating cycles
Sheath material	PUR
Sheathed cable color	black
Encapsulation	Fully encapsulated with conformal coating (UL 94 V0)

Environmental requirements

Ambient temperature (operation)	-25 ... +80 °C
Ambient (operating) temperature (dynamic)	-5 ... +80 °C
Ambient (operating) temperature (static)	-40 ... +80 °C
Protection type	IP68
Note on protection type	72 h at a depth of 1 m under water per EN 60529 in the fully locked position with its plugs or protective caps
Pollution degree	3 per VDE 0110
Vibration resistance	per IEC 60068-2-6
Shock resistance	per IEC 60068-2-27

Commercial data

eCl@ss 10.0	27-44-01-08
eCl@ss 9.0	27-44-01-08
ETIM 8.0	EC002585
ETIM 7.0	EC002585
PU (SPU)	1 pcs
Packaging type	box
Country of origin	DE
GTIN	4044918978651
Customs tariff number	85366990990

Environmental Product Compliance

CAS-No.	7439-92-1
REACH Candidate List Substance	Lead
RoHS Compliance Status	Compliant,With Exemption
RoHS Exemption	6(c)
SCIP notification number (Austria)	d927068f-0862-4876-bec4-3c5747f060cb
SCIP notification number (Belgium)	8ea47484-2b2e-4a37-a20a-43c520893a38

Subject to changes. Please also observe the further product documentation!

WAGO GmbH & Co. KG
 Hansastr. 27
 32423 Minden
 Phone: +49571 887-0 | Fax: +49571 887-169
 Email: info.de@wago.com | Web: www.wago.com

Do you have any questions about our products?
 We are always happy to take your call at +49 (571) 887-44222.

SCIP notification number (Bulgaria)	862a34f9-8614-4704-85be-5866511be648
SCIP notification number (Czech Republic)	71f02abb-c4a3-4678-8ad0-a88b1b0549a8
SCIP notification number (Denmark)	a19b16f0-f6bc-498a-bfb9-0a1225e0b9af
SCIP notification number (Finland)	1bd8e7f4-d8a8-49db-a71e-66f89201bbdf
SCIP notification number (France)	b3511dcf-5209-47de-a242-4a722570ac8a
SCIP notification number (Germany)	d27d00cd-1807-4d66-8f9a-0bdb895578d2
SCIP notification number (Hungary)	fcba20ea-a23b-422a-85dc-eeec7e447bbc9
SCIP notification number (Italy)	080061f7-2495-4c7c-b917-4ae6e9d5c975
SCIP notification number (Netherlands)	ac40203c-b420-4792-85b2-b4ba220b551e
SCIP notification number (Poland)	6917cd9b-ee06-4c69-86b5-dc78cf7495ee
SCIP notification number (Romania)	7e6a17cd-1074-49f0-8ec8-66780d57bca0
SCIP notification number (Sweden)	465cfbf6-c495-41bb-8079-8e2668fca334



Approvals / Certificates

General approvals

Logo	Approval	Additional Approval Text	Certificate name
	UL UL International Germany GmbH (ORDINARY LOCATIONS)	UL 508	E175199 Sec.5

Optional accessories

Marking accessories

Marking strip			
	Item no.: 757-001 Marking strips; not stretchable; snap-on type		www.wago.com/757-001
Marking devices			
	Item no.: 210-110 Fiber-tip pen		www.wago.com/210-110
Cover			
	Item no.: 756-8101 M8 protective cap; for unused sockets		www.wago.com/756-8101
Mounting			
Intermediate plate			

Subject to changes. Please also observe the further product documentation!



Item no.: 757-000
Spacer module for sensor/actuator box; 10-way

Downloads

Documentation

System Description

Sensor/Actuator Boxes – General Product Information		pdf 438.6 kB	Download
---	--	-----------------	----------

Additional Information

Disposal and Recycling	V 1.1.0	pdf	Download
Electrical and electronic equipment, Batteries, Packaging	2022 Aug 18	2.2 MB	

CAD/CAE-Data

CAE data

EPLAN Data Portal 757-403/000-005		URL	Download
WSCAD Universe 757-403/000-005		URL	Download
WSCAD Universe 757-403/000-005		URL	Download
EPLAN Data Portal 757-403/000-005		URL	Download
ZUKEN Portal 757-403/000-005		URL	Download

CAD data

2D/3D Models 757-403/000-005		URL	Download
------------------------------	--	-----	----------

Environmental Product Compliance

Compliance Search

Environmental Product Compliance 757-403/000-005		URL	Download
M8 sensor/actuator box; 10-way; 3-pole; 5 m			

Subject to changes. Please also observe the further product documentation!



Installation Notes

Subject to changes. Please also observe the further product documentation!

WAGO GmbH & Co. KG
Hansastr. 27
32423 Minden
Phone: +49571 887-0 | Fax: +49571 887-169
Email: info.de@wago.com | Web: www.wago.com

Do you have any questions about our products?
We are always happy to take your call at +49 (571) 887-44222.