

GABRIELLA-45-W

~35° wide beam with holder

SPECIFICATION:

| | |
|----------------|------------|
| Dimensions | Ø 45.0 mm |
| Height | 28.8 mm |
| Fastening | pin, screw |
| ROHS compliant | yes ⓘ |

MATERIALS:

| Component | Type | Material | Colour | Finish |
|-------------------------|-------------|----------|--------|--------|
| C15813_GABRIELLA-45-W | Single lens | PMMA | clear | |
| C15528_GABRIELLA-45-HLD | Holder | PC | black | |

ORDERING INFORMATION:

Quantities for one set:

| | |
|-------------|---|
| Single lens | 1 |
| Holder | 1 |





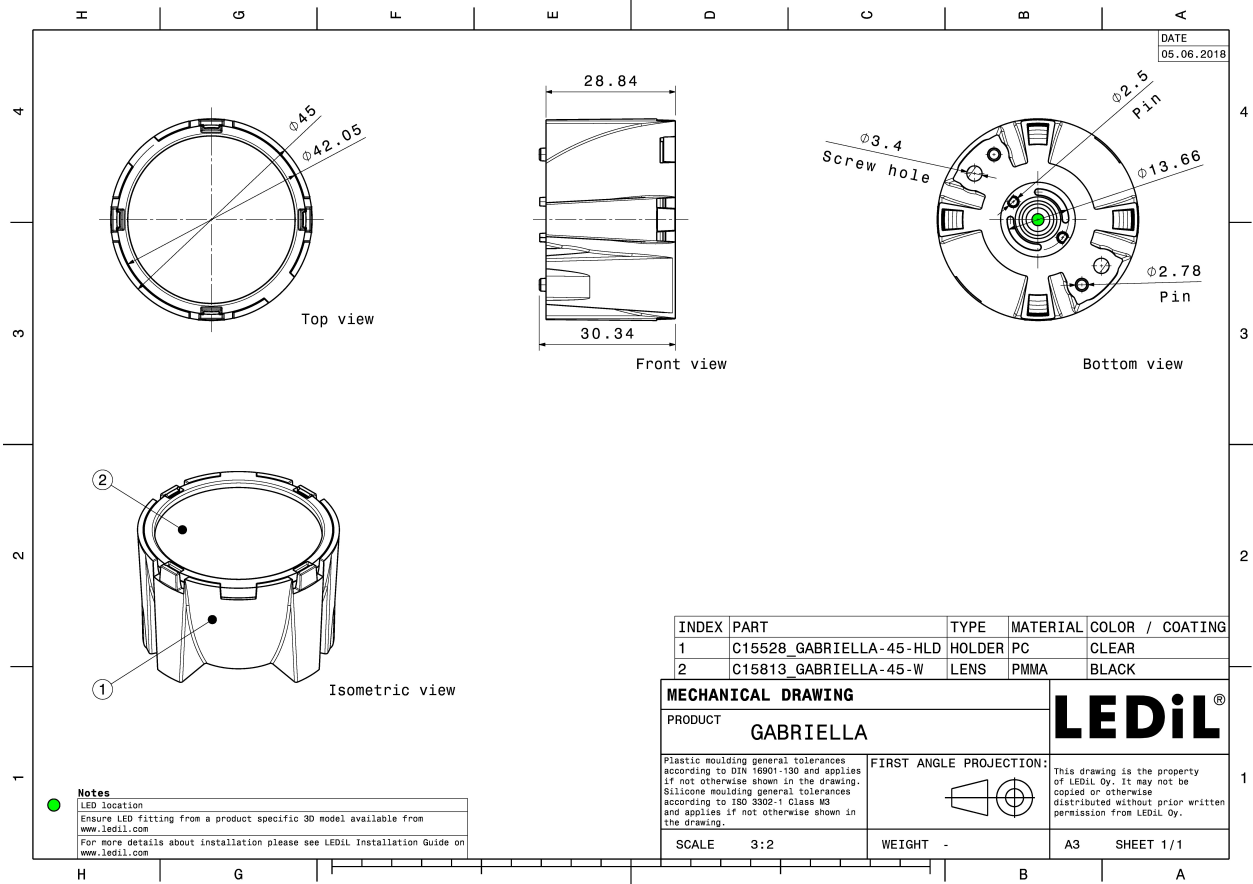

| Component | | Qty in box | MOQ | MPQ | Box weight (kg) |
|--------------------------------|-------------|------------|-----|-----|-----------------|
| C15813_GABRIELLA-45-W | Single lens | 405 | 90 | 45 | 8.6 |
| » Box size: 476 x 273 x 292 mm | | | | | |
| C15528_GABRIELLA-45-HLD | Holder | 405 | 90 | 45 | 5.1 |
| » Box size: 476 x 273 x 292 mm | | | | | |

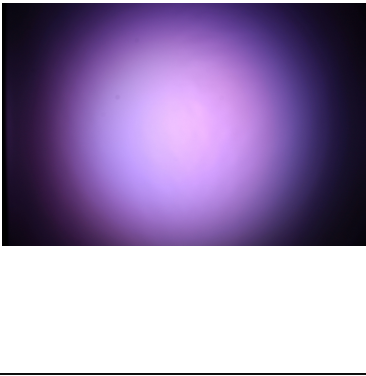
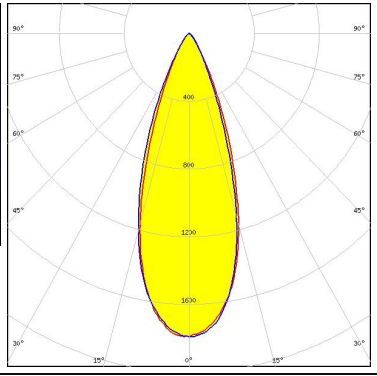

See also our general installation guide: www.ledil.com/installation_guide

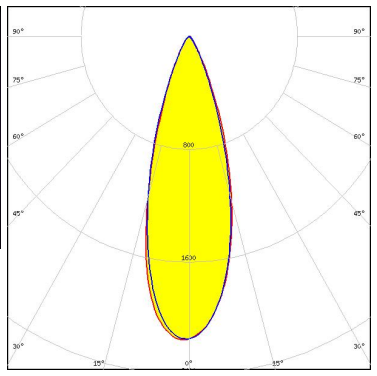

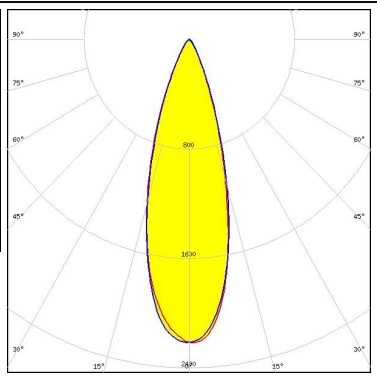
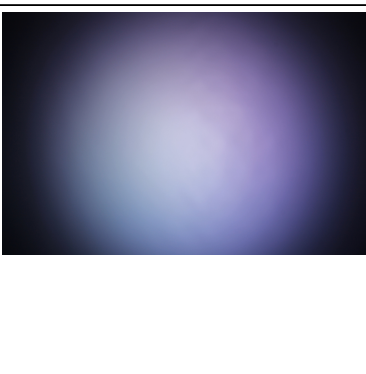
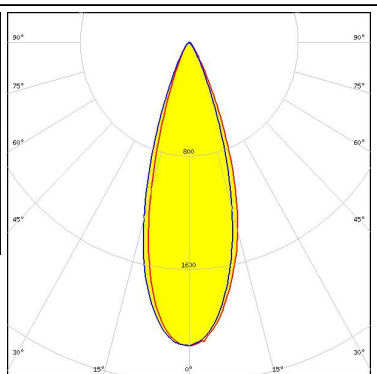

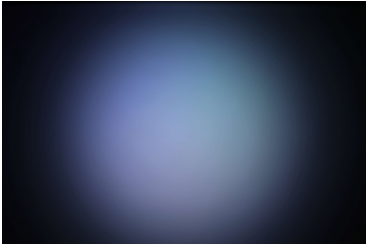
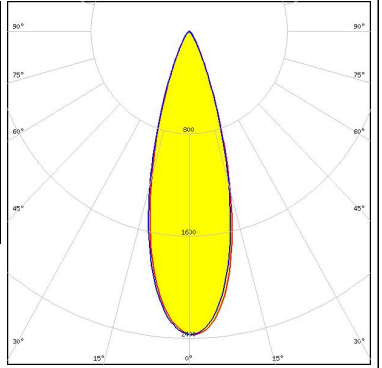
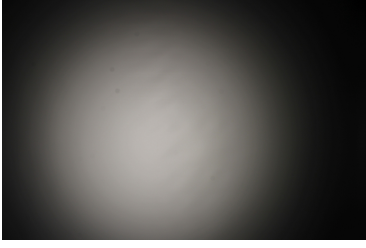
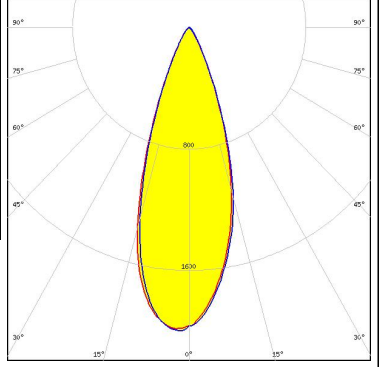
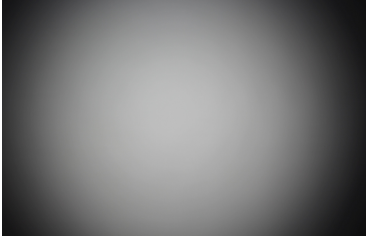
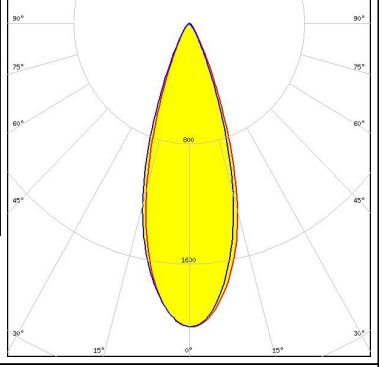
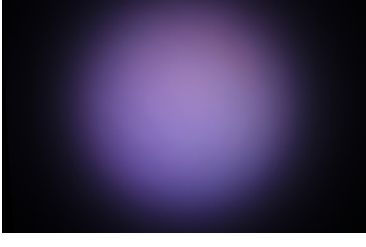
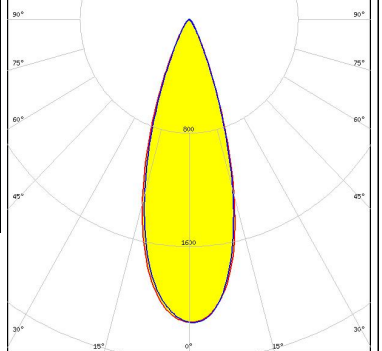

OPTICAL RESULTS (MEASURED):

| | | |
|--|--|---|
| <p>CREE LED</p> <p>LED XM-L RGBW (XMLCTW) FWHM / FWTM 37.0° / 62.0° Efficiency 79 % Peak intensity 1.8 cd/m LEDs/each optic 1 Light colour White Required components:</p> |  |  |
| <p>LUMILEDS</p> <p>LED LUXEON 5052 RGBW FWHM / FWTM 32.0° / 57.0° Efficiency 79 % Peak intensity 2.2 cd/m LEDs/each optic 1 Light colour RGBW Required components:</p> |  |  |
| <p>LUMILEDS</p> <p>LED LUXEON CZ FWHM / FWTM 31.0° / 56.0° Efficiency 78 % Peak intensity 2.2 cd/m LEDs/each optic 4 Light colour RGBW Required components:</p> |  |  |
| <p>LUMINUS</p> <p>LED SBM-40-RGBW FWHM / FWTM 33.0° / 56.0° Efficiency 80 % Peak intensity 2.1 cd/m LEDs/each optic 1 Light colour White Required components:</p> |  |  |

OPTICAL RESULTS (MEASURED):

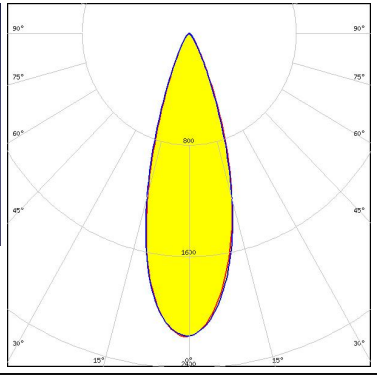
| | | |
|---|--|---|
| <p>NICHIA</p> <p>LED NCSxE17A FWHM / FWTM 31.0° / 54.0° Efficiency 81 % Peak intensity 2.4 cd/lm LEDs/each optic 4 Light colour RGBW Required components:</p> |  |  |
| <p>NICHIA</p> <p>LED NVSW219F FWHM / FWTM 35.0° / 59.0° Efficiency 80 % Peak intensity 2 cd/lm LEDs/each optic 1 Light colour White Required components:</p> |  |  |
| <p>OSRAM <small>Opto Semiconductors</small></p> <p>LED OSLON Square EC FWHM / FWTM 34.0° / 57.0° Efficiency 78 % Peak intensity 2 cd/lm LEDs/each optic 1 Light colour White Required components:</p> |  |  |
| <p>OSRAM <small>Opto Semiconductors</small></p> <p>LED Ostar-SMT RGB FWHM / FWTM 34.0° / 56.0° Efficiency 81 % Peak intensity 2.2 cd/lm LEDs/each optic 1 Light colour White Required components:</p> |  |  |

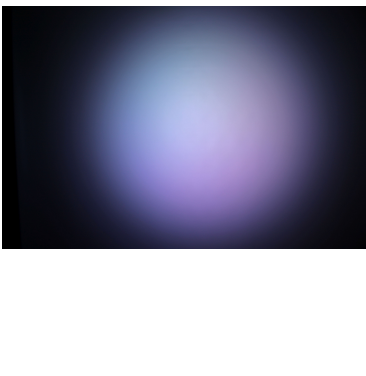
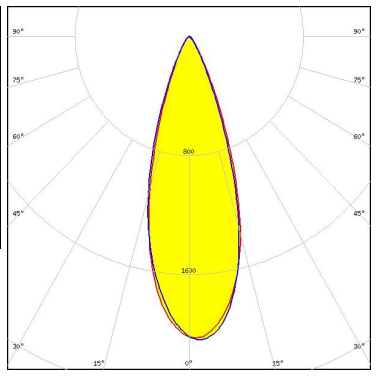
OPTICAL RESULTS (MEASURED):

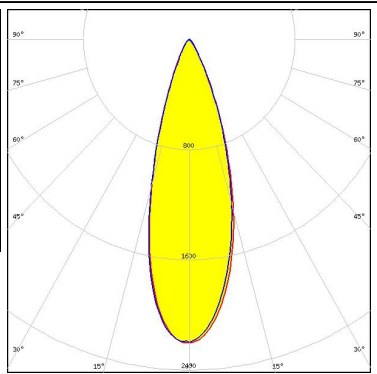
| | | |
|--|--|---|
| <p> SEUL SEMICONDUCTOR</p> <p>LED SPF05F0A</p> <p>FWHM / FWTM 33.0° / 56.0°</p> <p>Efficiency 78 %</p> <p>Peak intensity 2.2 cd/m</p> <p>LEDs/each optic 1</p> <p>Light colour RGBW</p> <p>Required components:</p> |  |  |
| <p> SEUL SEMICONDUCTOR</p> <p>LED SPF05F0B</p> <p>FWHM / FWTM 34.0° / 58.0°</p> <p>Efficiency 80 %</p> <p>Peak intensity 2.1 cd/m</p> <p>LEDs/each optic 1</p> <p>Light colour RGBW</p> <p>Required components:</p> |  |  |
| <p> SEUL SEMICONDUCTOR</p> <p>LED SPF05F0C</p> <p>FWHM / FWTM 32.0° / 56.0°</p> <p>Efficiency 79 %</p> <p>Peak intensity 2.2 cd/m</p> <p>LEDs/each optic 1</p> <p>Light colour RGBW</p> <p>Required components:</p> |  |  |

OPTICAL RESULTS (SIMULATED):

| | |
|--|--|
| <p>CREE → LED</p> <p>LED J Series 5050 Round LES</p> <p>FWHM / FWTM 33.0° / 54.0°</p> <p>Efficiency 90 %</p> <p>Peak intensity 2.7 cd/lm</p> <p>LEDs/each optic 1</p> <p>Light colour White</p> <p>Required components:</p> | |
| <p>CREE → LED</p> <p>LED XHP50.2</p> <p>FWHM / FWTM 36.0° / 60.0°</p> <p>Efficiency 87 %</p> <p>Peak intensity 2.2 cd/lm</p> <p>LEDs/each optic 1</p> <p>Light colour White</p> <p>Required components:</p> | |
| <p>CREE → LED</p> <p>LED XHP70.2</p> <p>FWHM / FWTM 35.0° / 62.0°</p> <p>Efficiency 85 %</p> <p>Peak intensity 2.1 cd/lm</p> <p>LEDs/each optic 1</p> <p>Light colour White</p> <p>Required components:</p> | |
| <p>CREE → LED</p> <p>LED XM-L RGBW (XMLDCL HD)</p> <p>FWHM / FWTM 43.0° / 67.0°</p> <p>Efficiency 90 %</p> <p>Peak intensity 1.7 cd/lm</p> <p>LEDs/each optic 1</p> <p>Light colour RGBW</p> <p>Required components:</p> | |

OPTICAL RESULTS (SIMULATED):

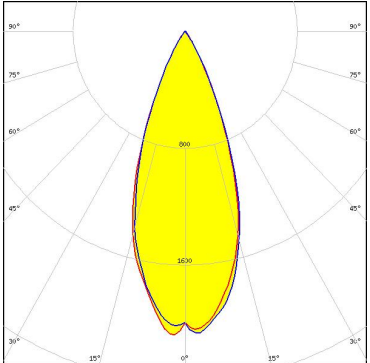
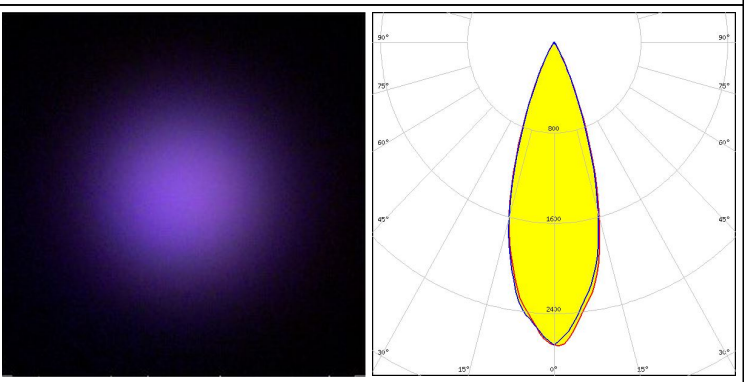
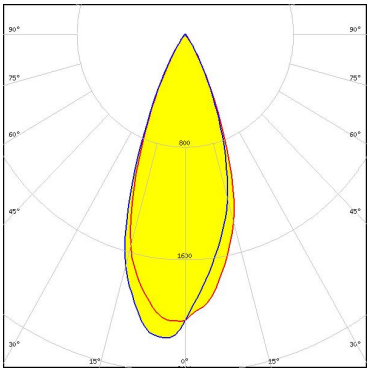
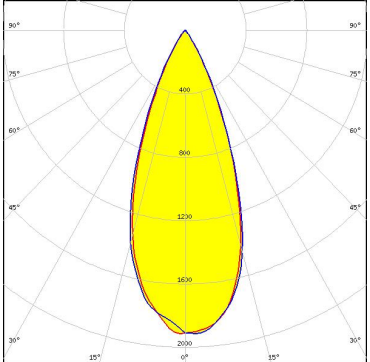
| | |
|--|---|
| <p>CREE LED</p> <p>LED XM-L RGBW (XMLDCL HI)</p> <p>FWHM / FWTM 40.0 + 39.0° / 62.0°</p> <p>Efficiency 91 %</p> <p>Peak intensity 2.1 cd/lm</p> <p>LEDs/each optic 1</p> <p>Light colour RGBW</p> <p>Required components:</p> |  |
| <p>LED ENGIN</p> <p>LED LZ7 Plus (LZ7-04M2PD)</p> <p>FWHM / FWTM 34.0° / 54.0°</p> <p>Efficiency 90 %</p> <p>Peak intensity 2.7 cd/lm</p> <p>LEDs/each optic 1</p> <p>Light colour White</p> <p>Required components:</p> |  |
| <p>LUMILEDS</p> <p>LED LUXEON Rubix</p> <p>FWHM / FWTM 39.0 + 38.0° / 62.0 + 61.0°</p> <p>Efficiency 91 %</p> <p>Peak intensity 2.2 cd/lm</p> <p>LEDs/each optic 4</p> <p>Light colour RGBW</p> <p>Required components:</p> |  |
| <p>OSRAM Opto Semiconductors</p> <p>LED DURIS E 5050 (GW J9LHS1.4M)</p> <p>FWHM / FWTM 40.0° / 64.0°</p> <p>Efficiency 90 %</p> <p>Peak intensity 1.9 cd/lm</p> <p>LEDs/each optic 1</p> <p>Light colour RGBW</p> <p>Required components:</p> |  |

OPTICAL RESULTS (SIMULATED):

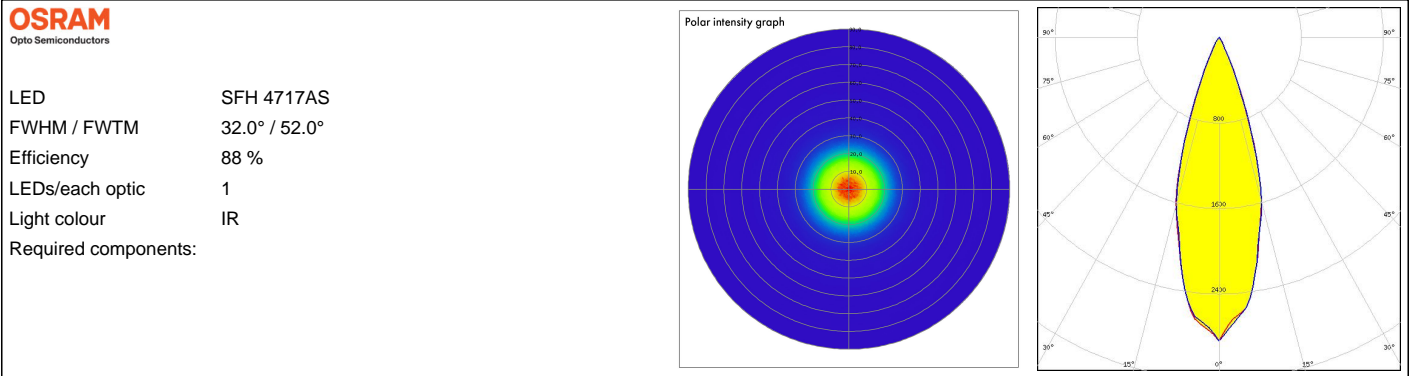

GENERAL INFORMATION:

NOTE: The typical beam angle will be changed by different color, chip size and chip position tolerance. The typical total beam angle is the full angle measured where the luminous intensity is half of the peak value.

MATERIALS:

As part of our continuous research and improvement processes, and to ensure the best possible quality and availability of our products, LEDiL reserves the right to change material grades without notice.

PRODUCT DATA USER AGREEMENT AND DISCLAIMER:

The measured data in the provided downloadable LEDiL Product Datasheets and Mechanical 2D-Drawings is rounded and provided as reference for planning. LEDiL Oy's optical specifications have been verified by conducting performance testing of the products in accordance with the company's quality system. The reported data are averaged results of multiple measurements with typical variation. LEDiL Oy reserves the right to without prior notification make changes and improvements to its products.

LEDiL Oy assumes neither warranty, nor guarantee nor any other liability of any kind for the contents and correctness of the provided data. The provided data has been generated with highest diligence but the provided data may in reality not represent the complete possible variation range of all intrinsic parameters. Therefore, in certain cases a deviation from the provided data could occur.

LEDiL Oy reserves the right to undertake technical changes of its products without further notification which could lead to changes in the provided data. LEDiL Oy assumes no liability of any kind for the possible deviation from any provided data or any other damage resulting from the usage of the provided data.

The user agrees to this disclaimer and user agreement with the download or usage of the provided files.

LEDiL Oy

Joensuunkatu 13
FI-24240 SALO
Finland

LEDiL Inc.

228 West Page Street
Suite D
Sycamore IL 60178
USA

Ledil Optics Technology (Shenzhen) Co., Ltd.

405 , Block B
Casic Motor Building
Shenzhen 518057
P.R.CHINA

Local sales and technical support

[www.ledil.com/
where_to_buy](http://www.ledil.com/where_to_buy)

Shipping locations

Salo, Finland
Hong Kong, China

Distribution Partners

[www.ledil.com/
where_to_buy](http://www.ledil.com/where_to_buy)