

Features

- Single Stage, Single Ended
- 5 V, 105 mA Operation
- 12 dB Flat Gain
- Low Noise
- Low Distortion Performance
- ESD Class 1C for HBM
- Lead-Free SOT-89 Plastic Package
- Halogen-Free “Green” Mold Compound
- RoHS* Compliant

Description

The MAAM-011258 is an RF amplifier assembled in a SOT-89 plastic package. This amplifier provides 12 dB of flat gain in both forward and reverse path applications. This amplifier provides excellent noise figure.

The MAAM-011258 provides high gain, low noise and low distortion making it ideally suited for 75 Ω infrastructure applications.

The MAAM-011258 is fabricated using GaAs pHEMT technology.

Functional Schematic

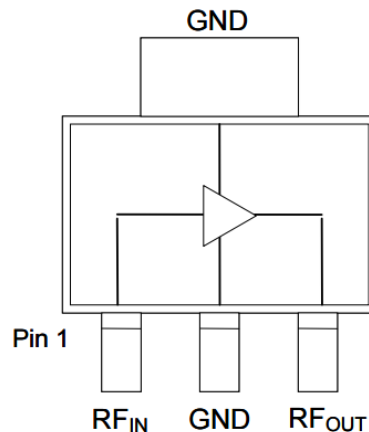

Pin Configuration

Pin No.	Pin Name	Function
1	RF _{IN}	RF Input
2	GND	RF and DC Ground
3	RF _{OUT}	RF Output / V _{DD}

Ordering Information^{1,2}

Part Number	Package
MAAM-011258-TR1000	1000 piece reel
MAAM-011258-TR3000	3000 piece reel
MAAM-011258-DSBSMB	Sample Board, 45 - 1218 MHz
MAAM-011258-USBSMB	Sample Board, 5 - 300 MHz

1. Reference Application Note M513 for reel size information.
2. All production sample boards include 5 loose parts.

* Restrictions on Hazardous Substances, European Union Directive 2011/65/EU.

75 Ω , High Linearity, Low Noise, CATV Amplifier, 12 dB Gain 5 - 1218 MHz

Rev. V2

Electrical Specifications: $T_A = 25^\circ\text{C}$, $V_{DD} = 5\text{ V}$, $Z_0 = 75\ \Omega$

Parameter	Test Conditions	Units	Min.	Typ.	Max.
Gain	45 - 1218 MHz	dB	11.5	12	13.5
Tilt	45 - 1218 MHz	dB	—	0.1	—
Reverse Isolation	45 - 1218 MHz	dB	—	17	—
Input Return Loss	45 - 1218 MHz	dB	—	20	—
Output Return Loss	45 - 1218 MHz	dB	—	20	—
Noise Figure	45 MHz 1218 MHz	dB	—	2.4 2.7	—
Output IP2	45 - 1218 MHz, tone spacing 6 MHz, P_{OUT} per tone = 2 dBm	dBm	—	52	—
Output IP3	45 - 1218 MHz, tone spacing 6 MHz, P_{OUT} per tone = 2 dBm	dBm	—	37	—
P1dB	—	dBm	—	18	—
Composite Triple Beat, CTB	79 channels, 0 dB Tilt, 32 dBmV per channel output, QAM to 1000 MHz	dBc	—	-75	—
Composite Second Order, CSO	79 channels, 0 dB Tilt, 32 dBmV per channel output, QAM to 1000 MHz	dBc	—	-65	—
I_{DD}	$V_{DD} = 5\text{ V}$	mA	—	105	125

Maximum Operating Conditions

Parameter	Absolute Maximum
RF Input Power CW	12 dBm
V_{DD}	7 volts
Operating Temperature ³	-40°C to +85°C
Junction Temperature ⁴	+150°C

- Operating at nominal conditions with $T_J \leq 150^\circ\text{C}$ will ensure $\text{MTTF} > 1 \times 10^6$ hours.
- Junction Temperature (T_J) = $T_C + \Theta_{JC} \cdot (V \cdot I)$
Typical thermal resistance (Θ_{JC}) = 44°C/W.
 - For $T_C = 25^\circ\text{C}$,
 $T_J = 47^\circ\text{C}$ @ 5 V, 105 mA
 - For $T_C = 85^\circ\text{C}$,
 $T_J = 105^\circ\text{C}$ @ 5 V, 95 mA

Absolute Maximum Ratings^{5,6}

Parameter	Absolute Maximum
RF Input Power CW	30 dBm
V_{DD}	8 volts
Storage Temperature	-55°C to +150°C
Junction Temperature ⁴	+175°C

- Exceeding any one or combination of these limits may cause permanent damage to this device.
- MACOM does not recommend sustained operation near these survivability limits.

Handling Procedures

Please observe the following precautions to avoid damage:

Static Sensitivity

Integrated Circuits are sensitive to electrostatic discharge (ESD) and can be damaged by static electricity. Proper ESD control techniques should be used when handling these HBM Class 1C devices.

Recommended PCB Layout, 45 - 1218 MHz

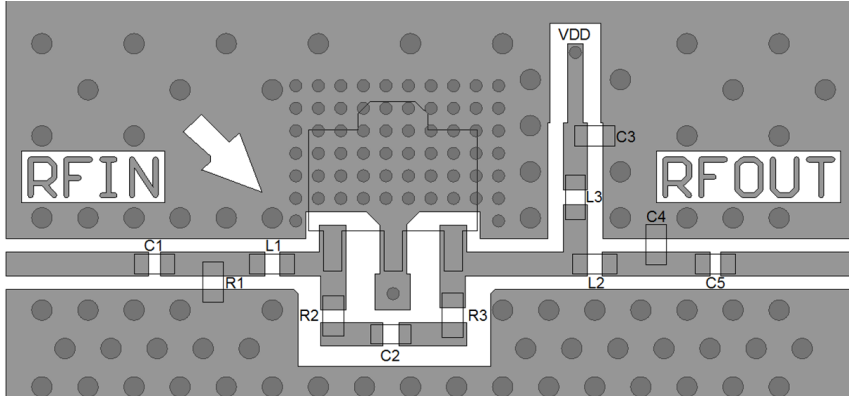

RF LINE WIDTH = 23 mil
BOARD MATERIAL = FR4
DIELECTRIC THICKNESS = 56 mil
GAP = 13 mil
BOARD THICKNESS = 62 mil

Application Schematic, 45 - 1218 MHz

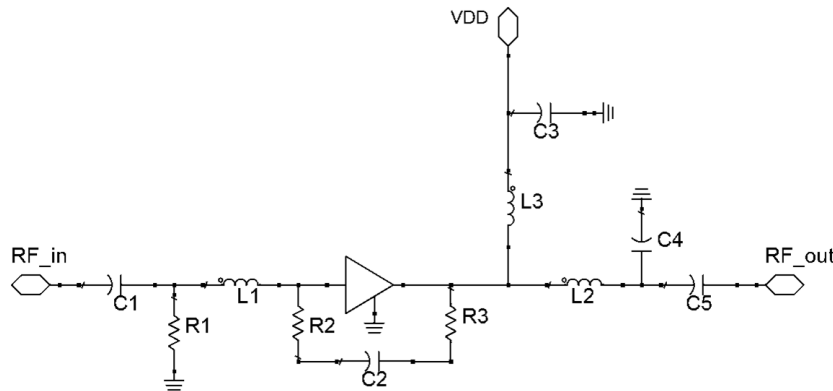

Parts List

Component	Value	Package
C1-C3	10 nF	0402
C4	0.9 pF	0402
C5	180 pF	0402
L1	5.1 nH	0402
L2	6.8 nH	0402
L3	Ferrite Bead ⁷	0402
R1	47 k Ω	0402
R2	160 Ω	0402
R3	240 Ω	0402

PCB Land Pattern⁸

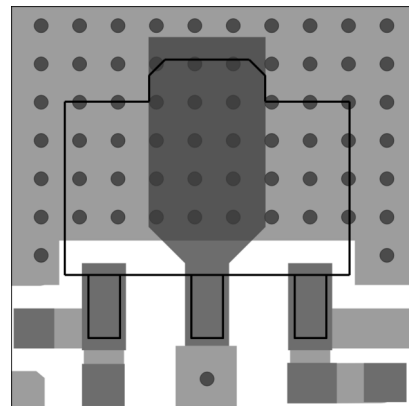

8. 62 vias beneath package, 0.012" via diameter

7. Ferrite Bead from Murata, part number BLM15HD182SN.

**75 Ω , High Linearity, Low Noise, CATV Amplifier, 12 dB Gain
5 - 1218 MHz**

Rev. V2

Typical Performance Curves: $V_{DD} = 5\text{ V}$, 45 - 1218 MHz Application

Gain

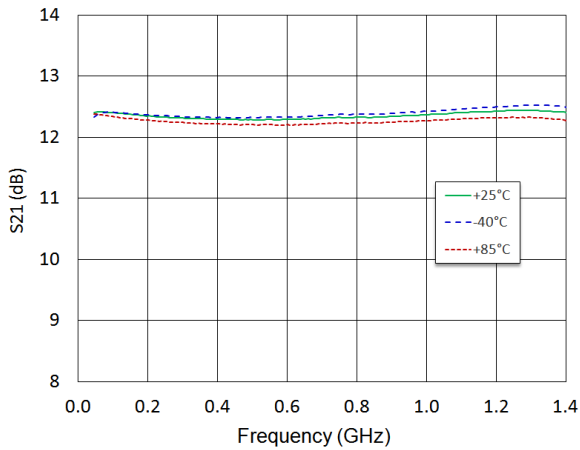

Gain to 3 GHz

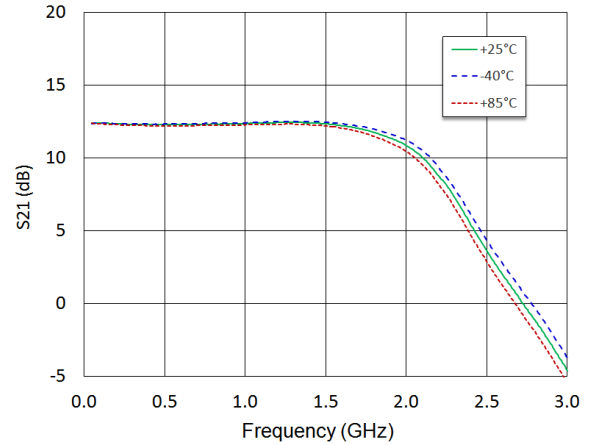

Input Return Loss

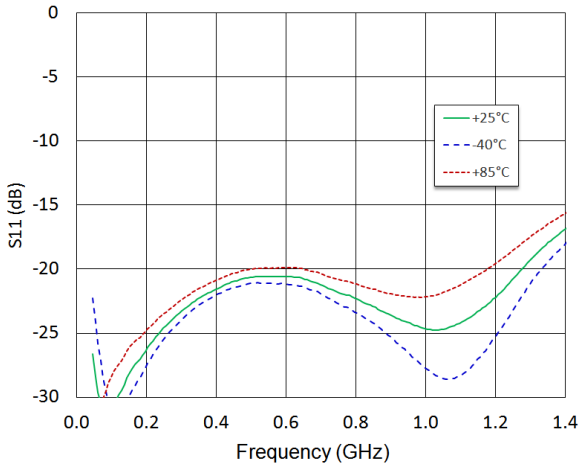

Output Return Loss

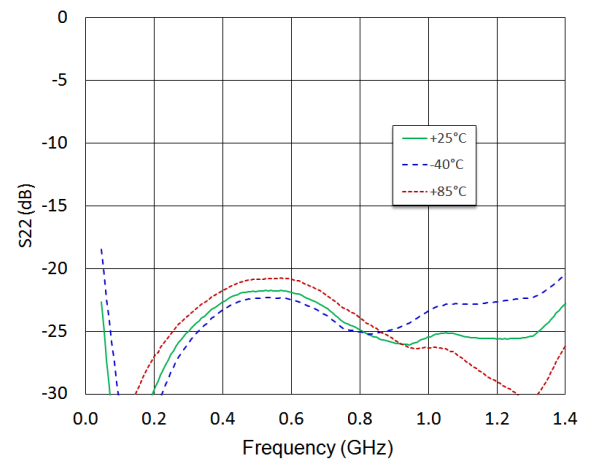

Reverse Isolation

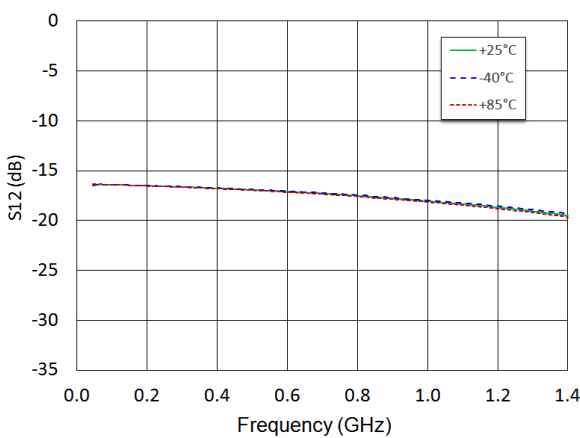

Noise Figure

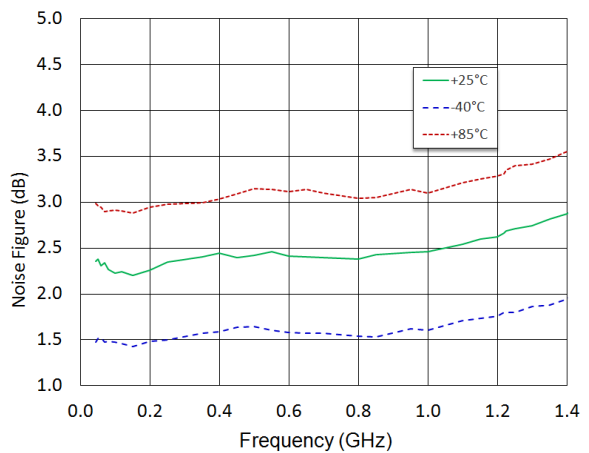

PRELIMINARY: Data Sheets contain information regarding a product MACOM has under development. Performance is based on engineering tests. Specifications are typical. Mechanical outline has been fixed. Engineering samples and/or test data may be available. Commitment to produce in volume is not guaranteed.

MACOM Technology Solutions Inc. (MACOM) and its affiliates reserve the right to make changes to the product(s) or information contained herein without notice.

For further information and support please visit: <https://www.macom.com/support>

75 Ω , High Linearity, Low Noise, CATV Amplifier, 12 dB Gain
5 - 1218 MHz

Rev. V2

Typical Performance Curves: $V_{DD} = 5\text{ V}$, 45 - 1218 MHz Application

OIP3, $P_{OUT} = +2\text{ dBm/tone}$

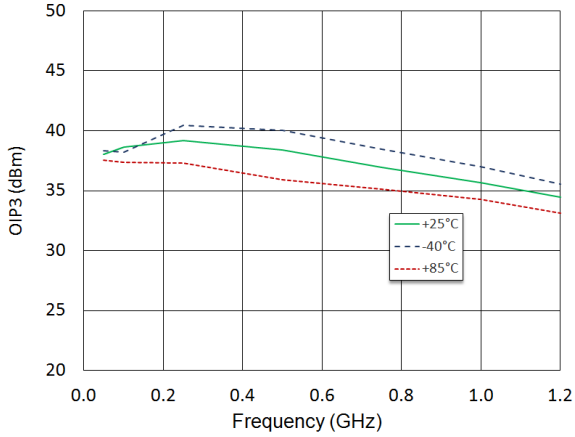

OIP2, $P_{OUT} = +2\text{ dBm/tone}$

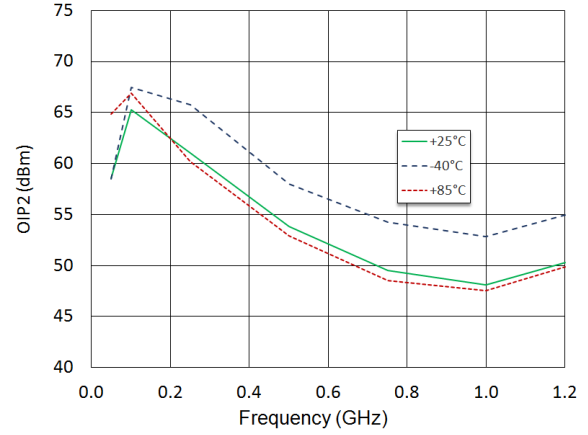

CSO Lower, 79 channels + QAM to 1 GHz, 0 dB tilt, 32 dBmV per channel

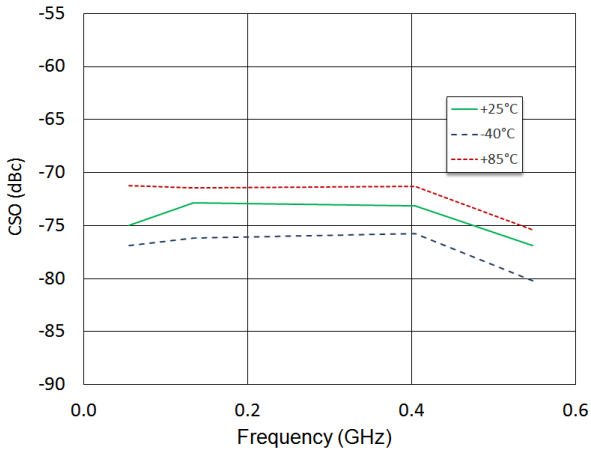

CSO Upper, 79 channels + QAM to 1 GHz, 0 dB tilt, 32 dBmV per channel

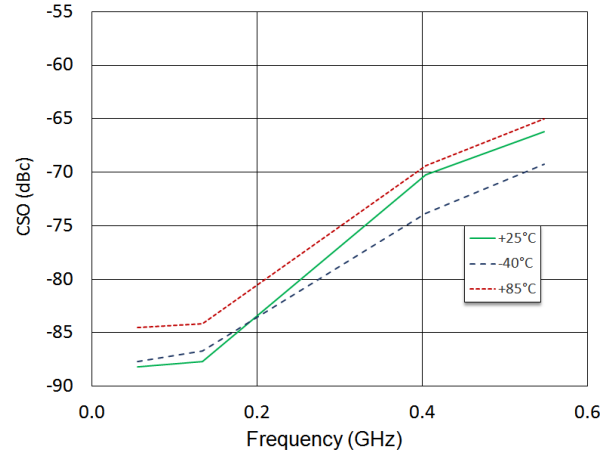

CTB, 79 channels + QAM to 1 GHz, 0 dB tilt, 32 dBmV per channel

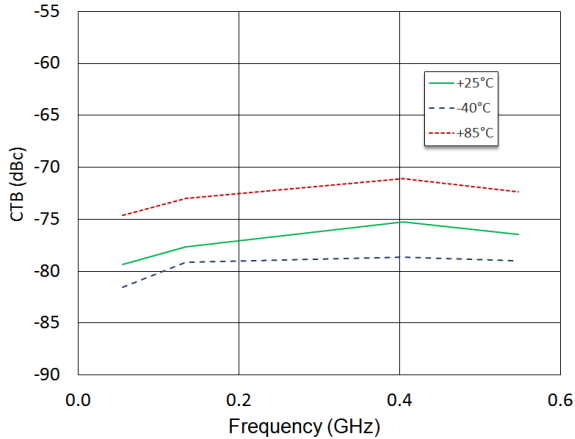

P1dB

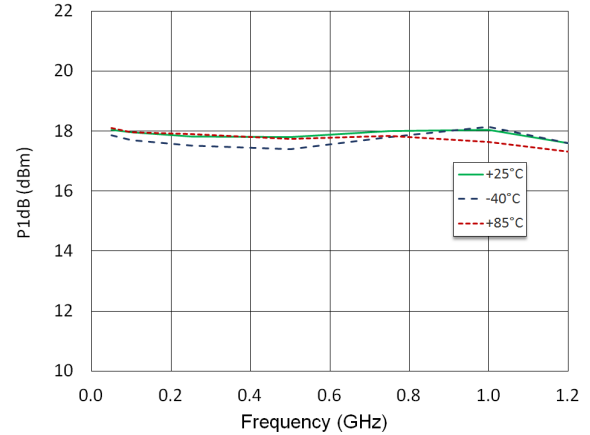

PRELIMINARY: Data Sheets contain information regarding a product MACOM has under development. Performance is based on engineering tests. Specifications are typical. Mechanical outline has been fixed. Engineering samples and/or test data may be available. Commitment to produce in volume is not guaranteed.

MACOM Technology Solutions Inc. (MACOM) and its affiliates reserve the right to make changes to the product(s) or information contained herein without notice.

For further information and support please visit: <https://www.macom.com/support>

Lead Free SOT-89[†]

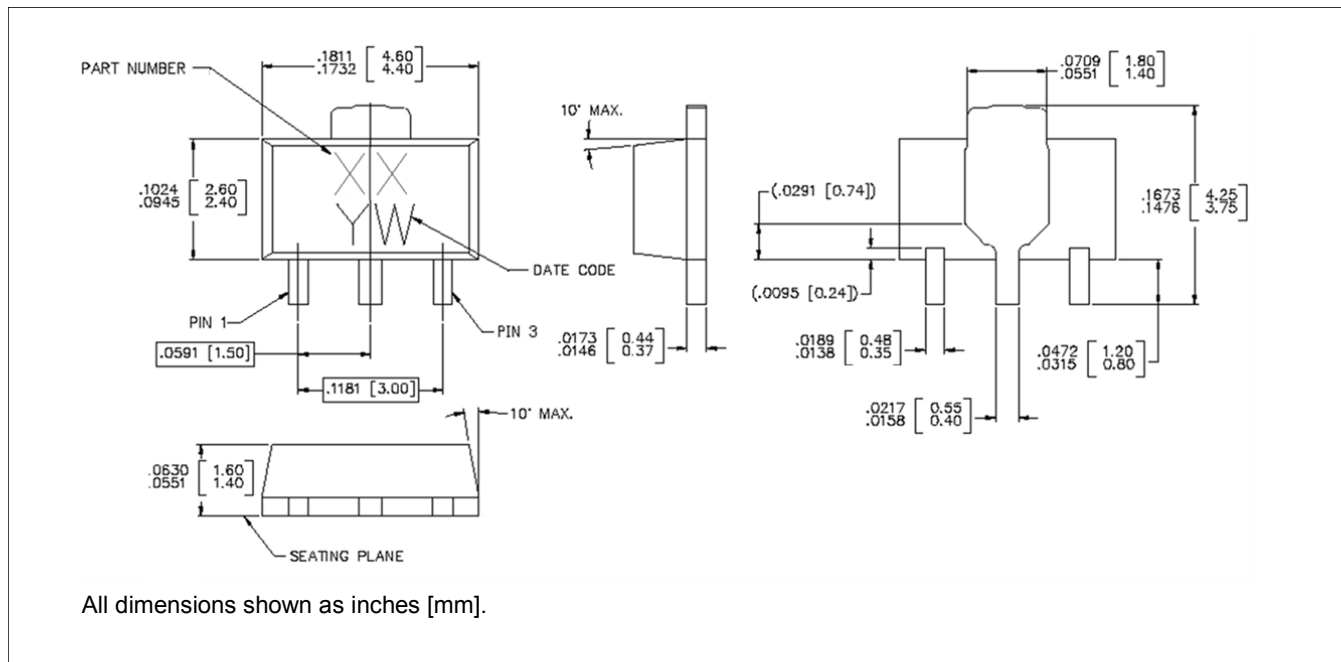

[†] Reference Application Note S2083 for lead-free solder reflow recommendations.
Meets JEDEC moisture sensitivity level 1 requirements.
Plating is 100% matte tin over copper.

Applications Section - 5 - 300 MHz Application

The MAAM-011258 may be tuned for operation in the 5 - 300 MHz band for CATV reverse path (upstream) applications using alternate external tuning components.

Typical Performance: $T_A = 25^\circ\text{C}$, $V_{DD} = 5\text{ V}$, $Z_0 = 75\ \Omega$

Parameter	Test Conditions	Units	Min.	Typ.	Max.
Gain	5 - 300 MHz	dB	—	12	—
Tilt	5 - 300 MHz	dB	—	0	—
Reverse Isolation	5 - 300 MHz	dB	—	16	—
Input Return Loss	5 - 300 MHz	dB	—	25	—
Output Return Loss	5 - 300 MHz	dB	—	24	—
Noise Figure	10 MHz 50 - 300 MHz	dB	—	2.9 2.4	—
Output IP2	5 - 300MHz, tone spacing 6 MHz, P_{OUT} per tone = 2 dBm	dBm	—	67	—
Output IP3	5 - 300MHz, tone spacing 6 MHz, P_{OUT} per tone = 2 dBm	dBm	—	39	—
P1dB	5 - 300 MHz	dBm	—	18	—
I_{DD}	$V_{DD} = 5\text{ V}$	mA	—	105	—
Noise Power Ratio	5 - 85 MHz, 41 MHz Notch, Peak NPR 5 - 204 MHz, 100 MHz Notch, Peak NPR	dB	—	71 68	—

Recommended PCB Layout

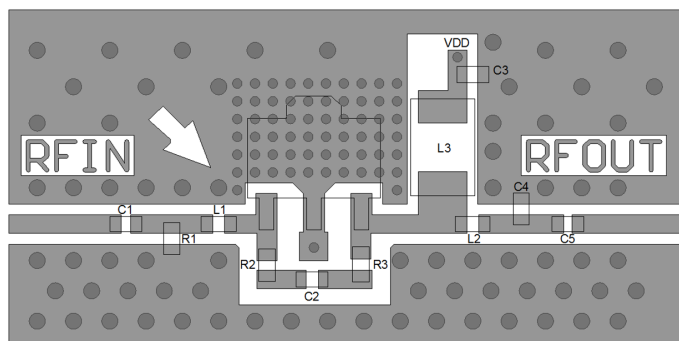

RF LINE WIDTH = 23 mil
BOARD MATERIAL = FR4
DIELECTRIC THICKNESS = 56 mil
GAP = 13 mil
BOARD THICKNESS = 62 mil

Parts List

Component	Value	Package
C1-C3	10 nF	0402
C4	Do Not Install	—
C5	4700 pF	0402
L1	0 Ω Resistor	0402
L2	3.9 nH	0402
L3	22 μH^9	0806
R1	47 k Ω	0402
R2	150 Ω	0402
R3	220 Ω	0402

9. Inductor from Murata, part number LQH2MCN220K02

75 Ω , High Linearity, Low Noise, CATV Amplifier, 12 dB Gain
5 - 1218 MHz

Rev. V2

Typical Performance Curves: $V_{DD} = 5\text{ V}$, 5 - 300 MHz Application

Gain

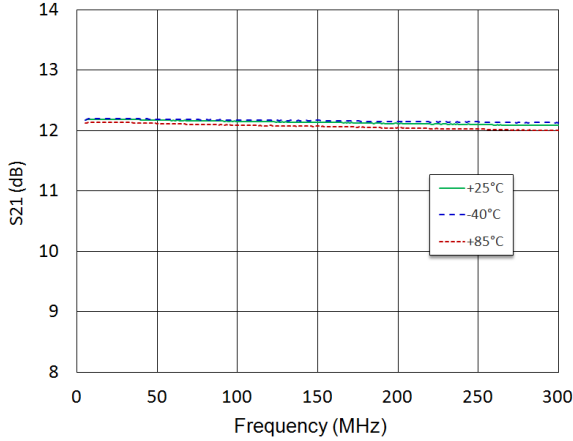

Input Return Loss

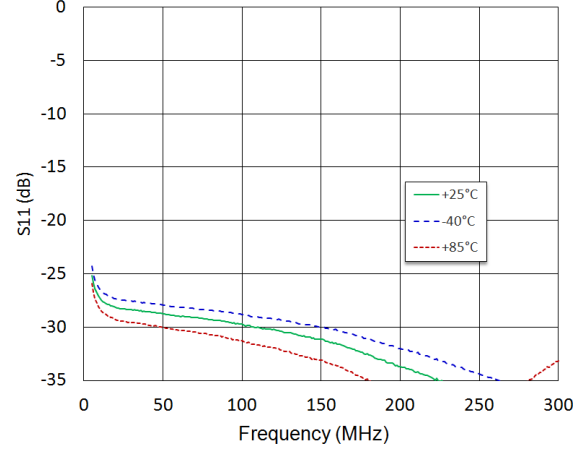

Output Return Loss

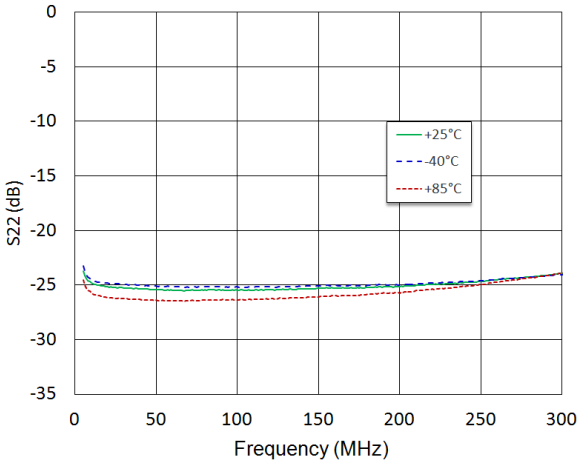

Noise Figure, 10 - 300MHz

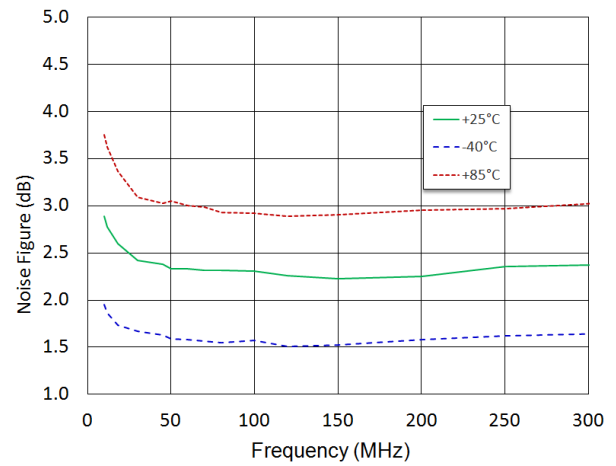

OIP3, $P_{OUT} = +2\text{ dBm/tone}$

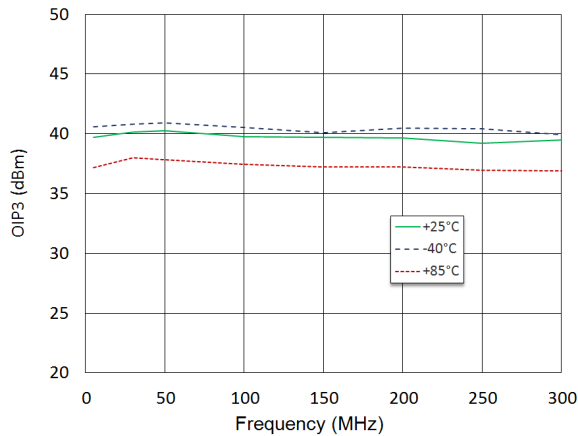

OIP2, $P_{OUT} = +2\text{ dBm/tone}$

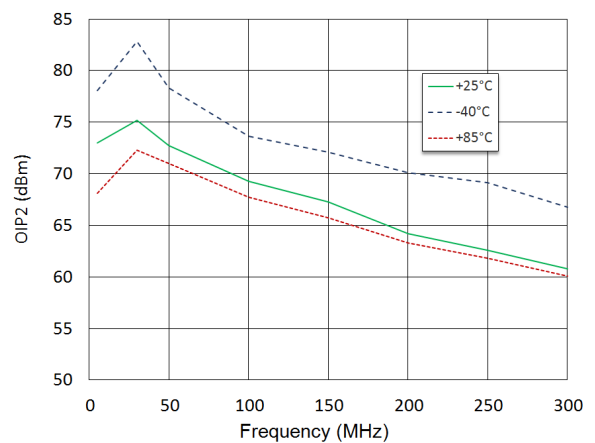

PRELIMINARY: Data Sheets contain information regarding a product MACOM has under development. Performance is based on engineering tests. Specifications are typical. Mechanical outline has been fixed. Engineering samples and/or test data may be available. Commitment to produce in volume is not guaranteed.

MACOM Technology Solutions Inc. (MACOM) and its affiliates reserve the right to make changes to the product(s) or information contained herein without notice.

For further information and support please visit: <https://www.macom.com/support>

75 Ω , High Linearity, Low Noise, CATV Amplifier, 12 dB Gain
5 - 1218 MHz

Rev. V2

Typical Performance Curves: $V_{DD} = 5\text{ V}$, 5 - 300 MHz Application

NPR, 5 - 85 MHz, 41 MHz Notch

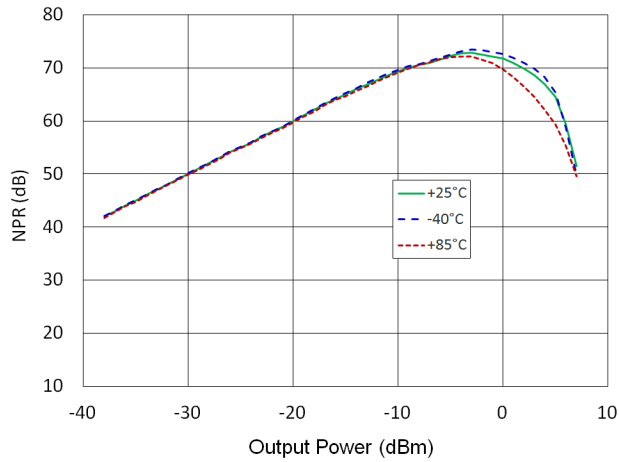

NPR, 5 - 204 MHz, 100 MHz Notch

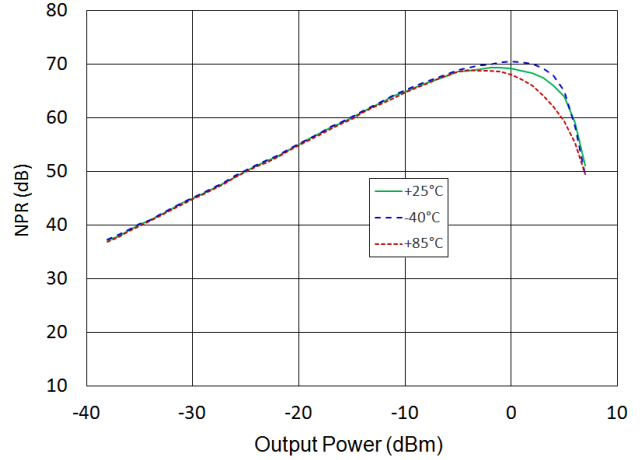

P1dB

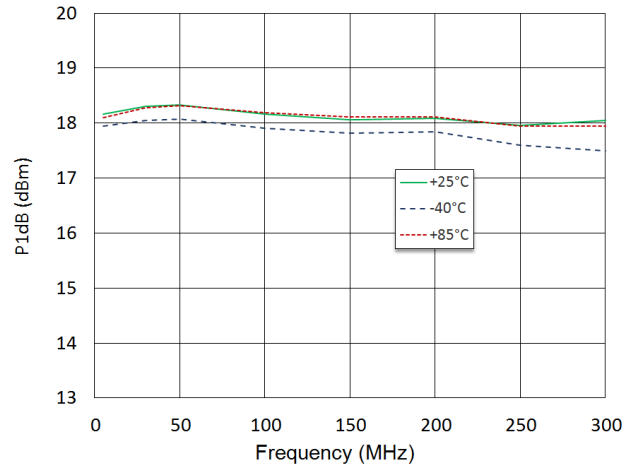

MACOM Technology Solutions Inc. All rights reserved.

Information in this document is provided in connection with MACOM Technology Solutions Inc ("MACOM") products. These materials are provided by MACOM as a service to its customers and may be used for informational purposes only. Except as provided in MACOM's Terms and Conditions of Sale for such products or in any separate agreement related to this document, MACOM assumes no liability whatsoever. MACOM assumes no responsibility for errors or omissions in these materials. MACOM may make changes to specifications and product descriptions at any time, without notice. MACOM makes no commitment to update the information and shall have no responsibility whatsoever for conflicts or incompatibilities arising from future changes to its specifications and product descriptions. No license, express or implied, by estoppel or otherwise, to any intellectual property rights is granted by this document.

THESE MATERIALS ARE PROVIDED "AS IS" WITHOUT WARRANTY OF ANY KIND, EITHER EXPRESS OR IMPLIED, RELATING TO SALE AND/OR USE OF MACOM PRODUCTS INCLUDING LIABILITY OR WARRANTIES RELATING TO FITNESS FOR A PARTICULAR PURPOSE, CONSEQUENTIAL OR INCIDENTAL DAMAGES, MERCHANTABILITY, OR INFRINGEMENT OF ANY PATENT, COPYRIGHT OR OTHER INTELLECTUAL PROPERTY RIGHT. MACOM FURTHER DOES NOT WARRANT THE ACCURACY OR COMPLETENESS OF THE INFORMATION, TEXT, GRAPHICS OR OTHER ITEMS CONTAINED WITHIN THESE MATERIALS. MACOM SHALL NOT BE LIABLE FOR ANY SPECIAL, INDIRECT, INCIDENTAL, OR CONSEQUENTIAL DAMAGES, INCLUDING WITHOUT LIMITATION, LOST REVENUES OR LOST PROFITS, WHICH MAY RESULT FROM THE USE OF THESE MATERIALS.

MACOM products are not intended for use in medical, lifesaving or life sustaining applications. MACOM customers using or selling MACOM products for use in such applications do so at their own risk and agree to fully indemnify MACOM for any damages resulting from such improper use or sale.