

ULTRA LOW PHASE NOISE AMPLIFIER MODULE, 3 - 8 GHz



Typical Applications

The HMC-C079 is ideal for:

- Microwave Radio
- Military & Space
- Test Instrumentation
- VSAT

Functional Diagram

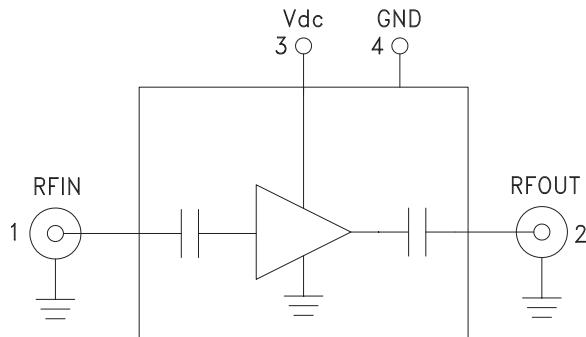

Features

- Ultra Low Phase Noise: -162 dBc/Hz @ 1 kHz
- Noise Figure: 6 dB
- Gain: 11 dB
- Psat: +21 dBm
- 50 Ohm Matched Input/Output
- Single Supply Voltage: +7V @ 110mA
- Hermetically Sealed Module
- Field Replaceable SMA Connectors
- 55 °C to +85 °C Operating Temperature

General Description

The HMC-C079 is a GaAs HBT Ultra Low Noise Amplifier in a miniature, hermetic module designed to operate between 3 and 8 GHz. This high dynamic range amplifier module provides 11 dB of gain, 6 dB noise figure and up to +21 dBm of output power with a single supply of +7V. The ultra low phase noise contribution of -162 dBc/Hz at 1 kHz offset, enables superior modulation accuracy within transceiver architectures. The wideband distributed amplifier I/O's are internally matched to 50 Ohms and DC blocked for robust performance. The module features removable SMA connectors which can be detached to allow direct connection of the I/O pins to a microstrip or coplanar circuit.

Electrical Specifications, $T_A = +25^\circ\text{C}$, $V_{dc} = +7\text{V}$

Parameter	Min.	Typ.	Max.	Units
Frequency Range		3 - 8		GHz
Vdc Range	6.5	7	8	V
Gain	9	11		dB
Gain Variation Over Temperature		0.01		dB/ °C
Noise Figure		6		dB
Input Return Loss		18		dB
Output Return Loss		20		dB
Output Power for 1 dB Compression (P1dB)	11	14		dBm
Saturated Output Power (Psat)		21		dBm
Output Third Order Intercept (IP3)		25		dBm
Phase Noise @ 100 Hz, Psat, 6 GHz		-148		dBc/Hz
Phase Noise @ 1 kHz, Psat, 6 GHz		-162		dBc/Hz
Phase Noise @ 10 kHz, Psat, 6 GHz		-168		dBc/Hz
Supply Current (Quiescent)		110	150	mA
Supply Current (Under RF Drive)			250	mA

Information furnished by Analog Devices is believed to be accurate and reliable. However, no responsibility is assumed by Analog Devices for its use, nor for any infringements of patents or other rights of third parties that may result from its use. Specifications subject to change without notice. No license is granted by implication or otherwise under any patent or patent rights of Analog Devices. Trademarks and registered trademarks are the property of their respective owners.

For price, delivery, and to place orders: Analog Devices, Inc., One Technology Way, P.O. Box 9106, Norwood, MA 02062-9106
Phone: 781-329-4700 • Order online at www.analog.com
Application Support: Phone: 1-800-ANALOG-D



ULTRA LOW PHASE NOISE AMPLIFIER MODULE, 3 - 8 GHz

Broadband, Gain & Return Loss

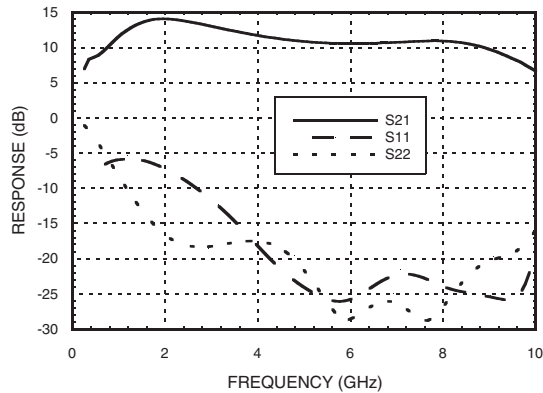

Gain vs. Temperature

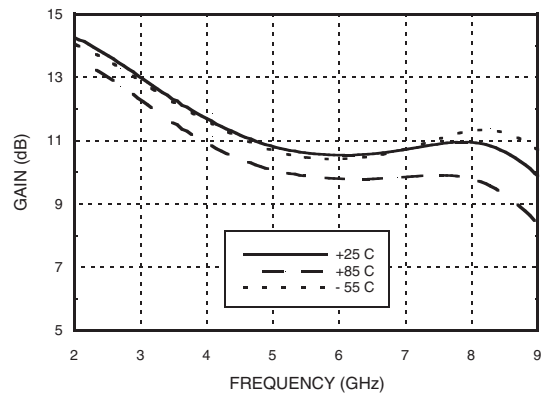

Input Return Loss vs. Temperature

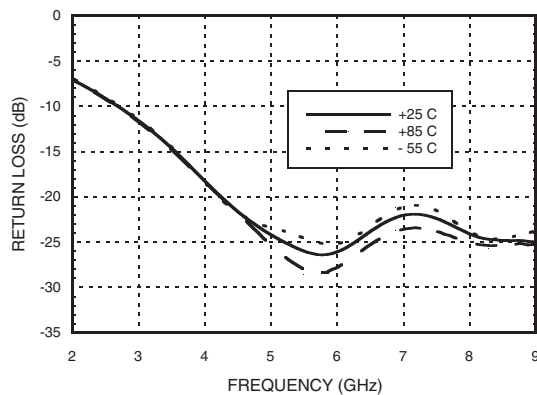

Output Return Loss vs. Temperature

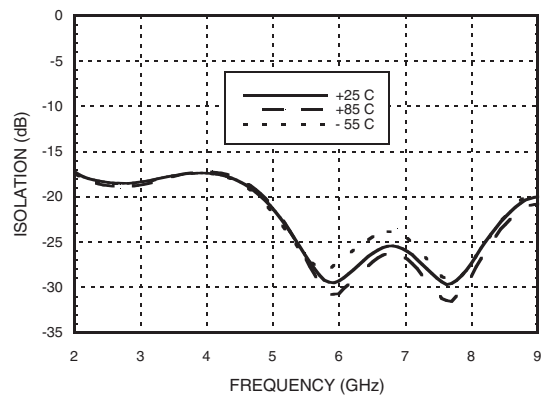

Reverse Isolation vs. Temperature

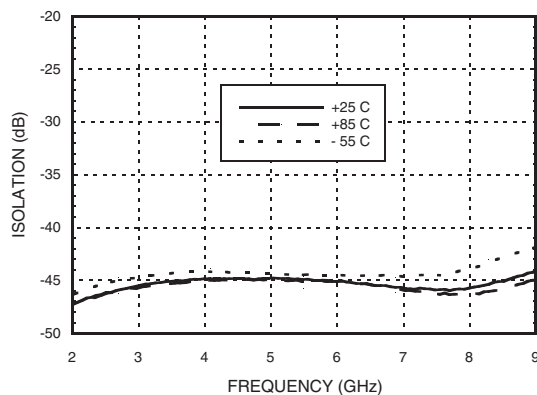

Noise Figure vs. Temperature

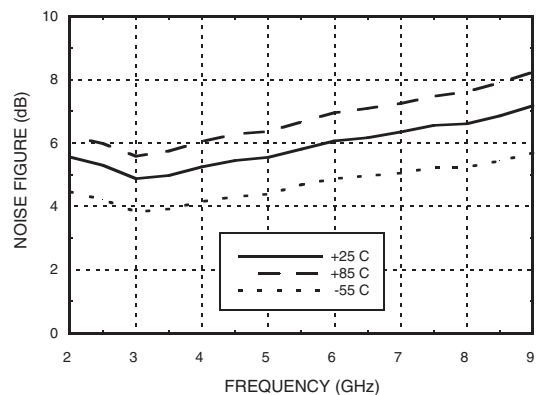

Information furnished by Analog Devices is believed to be accurate and reliable. However, no responsibility is assumed by Analog Devices for its use, nor for any infringements of patents or other rights of third parties that may result from its use. Specifications subject to change without notice. No license is granted by implication or otherwise under any patent or patent rights of Analog Devices. Trademarks and registered trademarks are the property of their respective owners.

For price, delivery, and to place orders: Analog Devices, Inc., One Technology Way, P.O. Box 9106, Norwood, MA 02062-9106 Phone: 781-329-4700 • Order online at www.analog.com Application Support: Phone: 1-800-ANALOG-D



**ULTRA LOW PHASE NOISE
AMPLIFIER MODULE, 3 - 8 GHz**

Output P1dB vs. Temperature

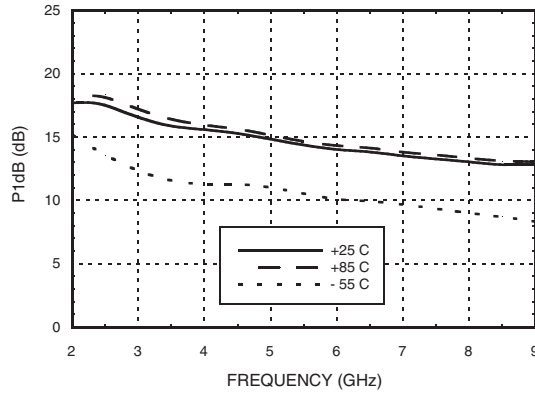

Output Psat vs. Temperature

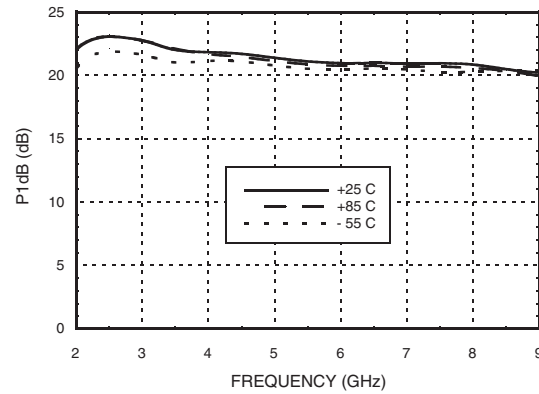

Output IP3 vs. Temperature

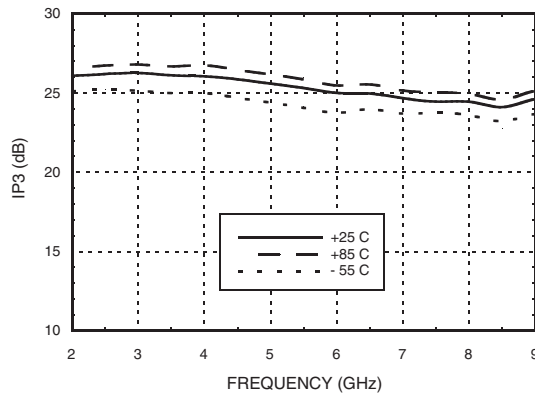

Phase Noise at Pout = 10 dBm @ 3.5 GHz

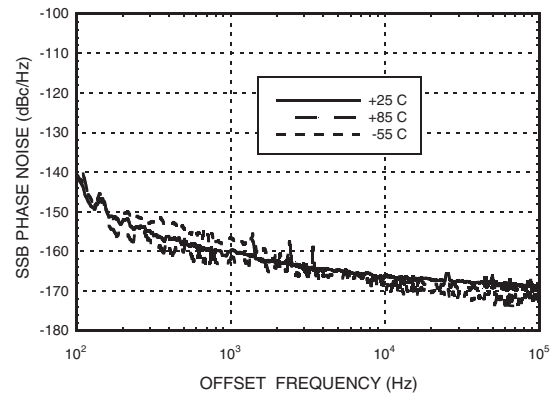

Phase Noise at Pout = P1dB @ 3.5 GHz

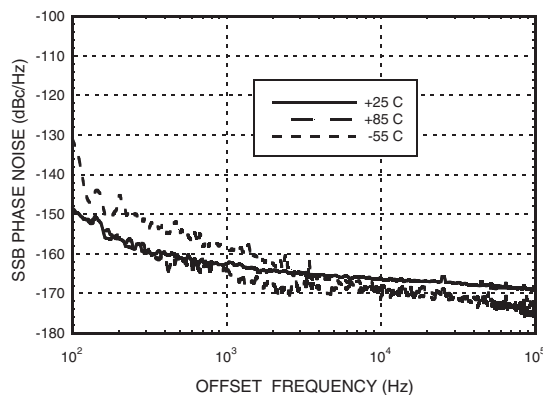

Phase Noise at Pout = Psat @ 3.5 GHz

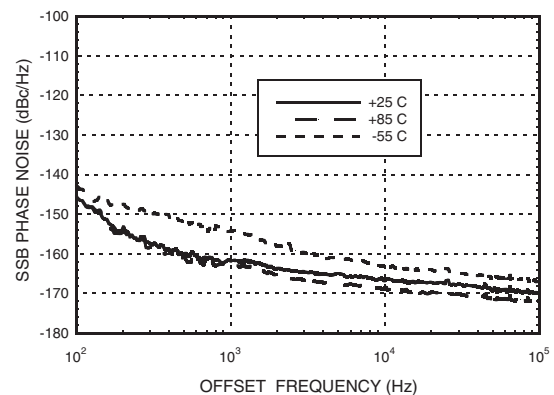

Information furnished by Analog Devices is believed to be accurate and reliable. However, no responsibility is assumed by Analog Devices for its use, nor for any infringements of patents or other rights of third parties that may result from its use. Specifications subject to change without notice. No license is granted by implication or otherwise under any patent or patent rights of Analog Devices. Trademarks and registered trademarks are the property of their respective owners.

For price, delivery, and to place orders: Analog Devices, Inc., One Technology Way, P.O. Box 9106, Norwood, MA 02062-9106 Phone: 781-329-4700 • Order online at www.analog.com Application Support: Phone: 1-800-ANALOG-D



ULTRA LOW PHASE NOISE AMPLIFIER MODULE, 3 - 8 GHz

Phase Noise at Pout = 10 dBm @ 5.12 GHz

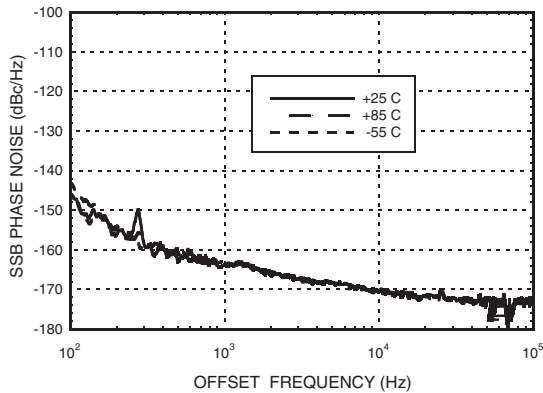

Phase Noise at Pout = P1dB @ 5.12 GHz

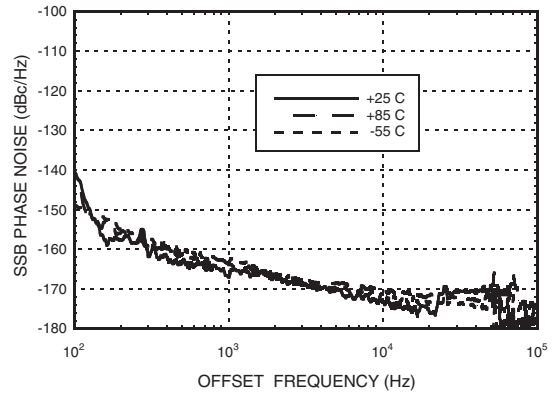

Phase Noise at Pout = Psat @ 5.12 GHz

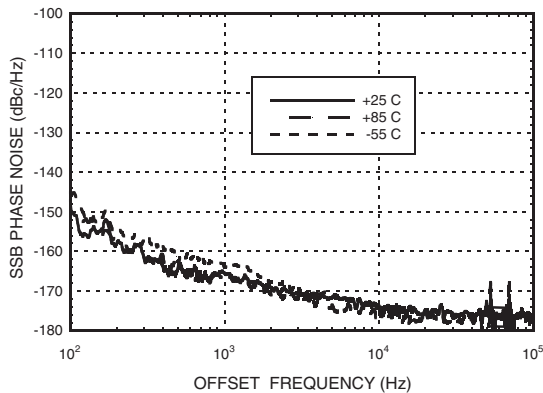

Phase Noise at Pout = 10 dBm @ 7 GHz

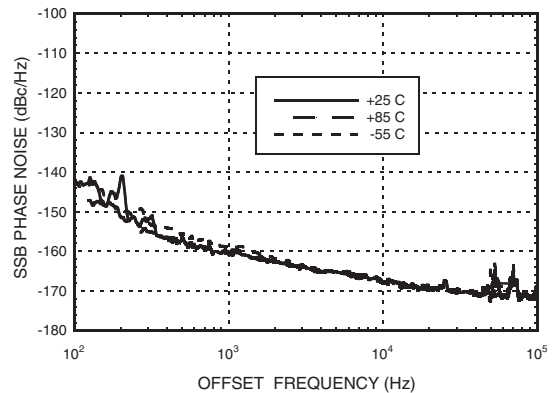

Phase Noise at Pout = P1dB @ 7 GHz

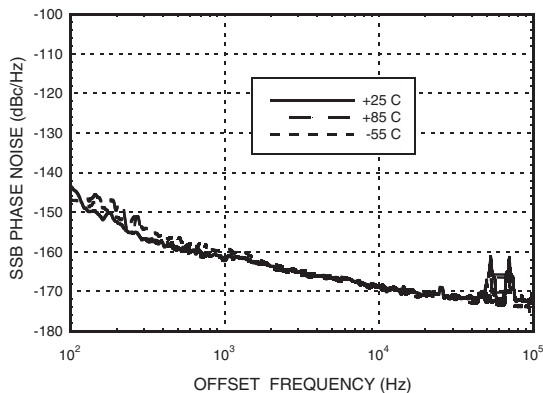

Phase Noise at Pout = Psat @ 7 GHz

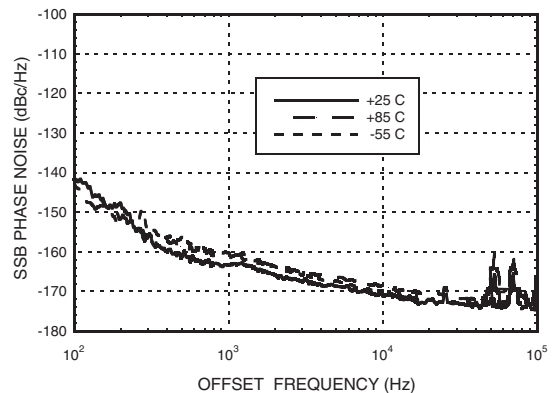

Information furnished by Analog Devices is believed to be accurate and reliable. However, no responsibility is assumed by Analog Devices for its use, nor for any infringements of patents or other rights of third parties that may result from its use. Specifications subject to change without notice. No license is granted by implication or otherwise under any patent or patent rights of Analog Devices. Trademarks and registered trademarks are the property of their respective owners.

For price, delivery, and to place orders: Analog Devices, Inc., One Technology Way, P.O. Box 9106, Norwood, MA 02062-9106 Phone: 781-329-4700 • Order online at www.analog.com Application Support: Phone: 1-800-ANALOG-D

ULTRA LOW PHASE NOISE AMPLIFIER MODULE, 3 - 8 GHz



Absolute Maximum Ratings

Bias Supply Voltage (V)	+8V
RF Input Power (RFIN)	+15 dBm
Continuous P _{diss} (T = 85 °C)	1.2W
Storage Temperature	-65 to +150 °C
Operating Temperature	-55 to +85 °C
ESD Sensitivity (HBM)	Class 1A



**ELECTROSTATIC SENSITIVE DEVICE
OBSERVE HANDLING PRECAUTIONS**

Pin Descriptions

Pin Number	Function	Description	Interface Schematic
1	RFIN & RF Ground	RF input connector, coaxial female, field replaceable. This pin is AC coupled and matched to 50 Ohms.	
2	RFOUT & RF Ground	RF output connector, coaxial female, field replaceable. This pin is AC coupled and matched to 50 Ohms.	
3	Vdc	Power supply voltage for the amplifier.	
4	GND	Power supply ground.	

**ULTRA LOW PHASE NOISE
AMPLIFIER MODULE, 3 - 8 GHz**



Outline Drawing

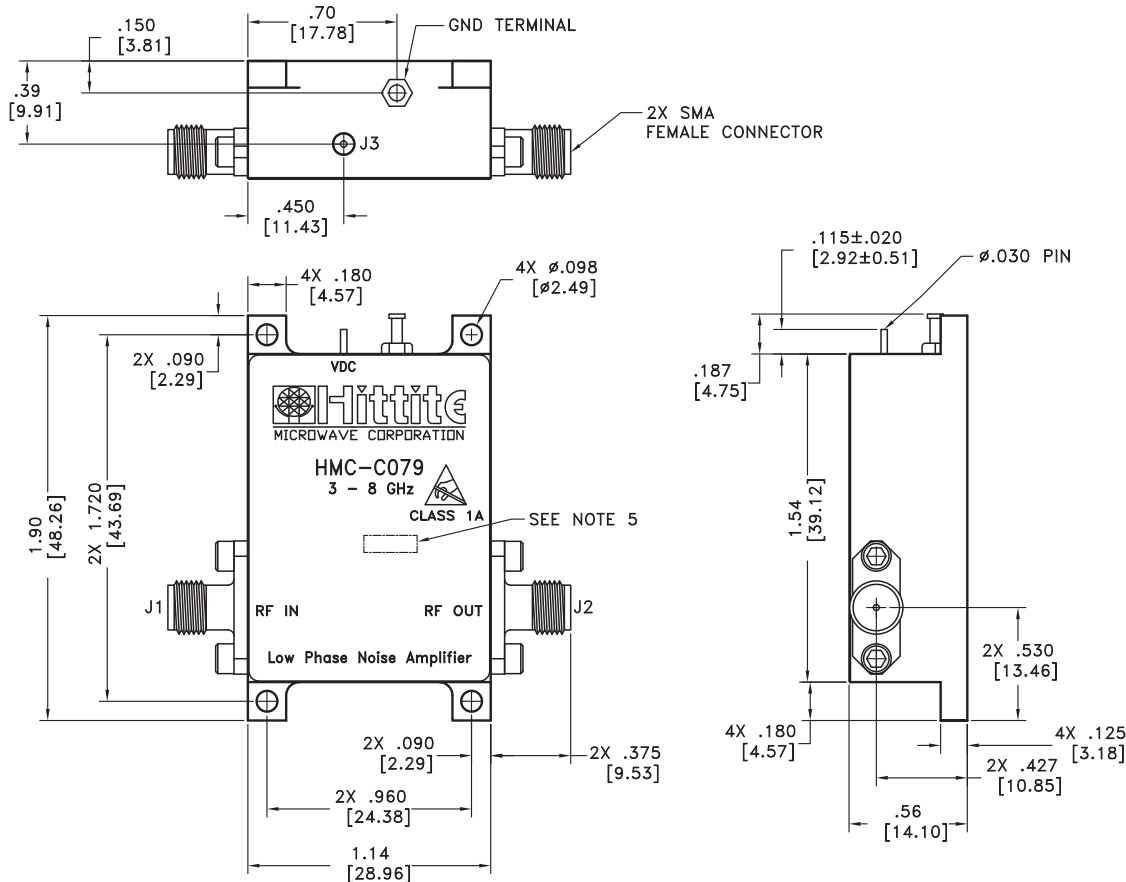

Package Information

Package Type	C-16
Package Weight	107 gms [1]

[1] ±1 gms Tolerance

NOTES:

1. PACKAGE, LEADS, COVER MATERIAL: KOVAR™
2. FINISH: GOLD PLATE OVER NICKEL PLATE.
3. ALL DIMENSIONS ARE IN INCHES [MILLIMETERS].
4. TOLERANCES:
 - 4.1 .XX = ±.02
 - 4.2 .XXX = ±.010
5. MARK LOT NUMBER ON 0.080 X 0.250 LABEL WHERE SHOWN, WITH 0.030" MIN TEXT HEIGHT.