

## Product Summary

V <sub>RRM</sub> (V)	I <sub>O</sub> (A)	V <sub>F</sub> Max (V) @ +25°C	I <sub>R</sub> Max (mA) @ +25°C
45	15	0.84	0.1
60	15	0.90	1.0

## Description and Applications

The MBR1545CT & MBR1560CT are designed to meet the stringent requirements of commercial applications, such as:

- Polarity Protection Diodes
- Re-Circulating Diodes
- Switching Diodes

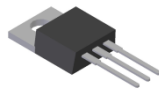

TO220AB  
Top View

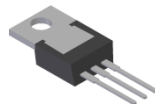

TO220AB  
Bottom View

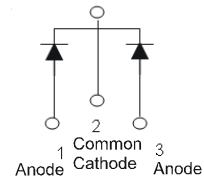

Package Pin-Out  
Configuration

## Features and Benefits

- Guard Ring Die Construction for Transient Protection
- Low Power Loss, High Efficiency
- High Surge Capability
- High Current Capability and Low Forward Voltage Drop
- For Use in Low-Voltage, High Frequency Inverters, and Free Wheeling Diodes
- **Lead-Free Finish; RoHS Compliant (Notes 1 & 2)**
- **Halogen and Antimony Free. "Green" Device (Note 3)**
- **Qualified to AEC-Q101 Standards for High Reliability**

## Mechanical Data

- Case: TO220AB
- Case Material: Molded Plastic.  
UL Flammability Classification Rating 94V-0
- Moisture Sensitivity: Level 1 per J-STD-020C
- Terminals: Finish – Tin.  
Solderable per MIL-STD-202, Method 208 Ⓢ3
- Polarity: As Marked on Body
- Weight: 2.24 grams (Approximate)

## Ordering Information (Note 4)

Device	Packaging	Shipping
MBR1545CT	TO220AB	50/Tube
MBR1560CT	TO220AB	50/Tube

- Notes:
1. EU Directive 2002/95/EC (RoHS) & 2011/65/EU (RoHS 2) compliant. All applicable RoHS exemptions applied.
  2. See [http://www.diodes.com/quality/lead\\_free.html](http://www.diodes.com/quality/lead_free.html) for more information about Diodes Incorporated's definitions of Halogen- and Antimony-free, "Green" and Lead-free.
  3. Halogen- and Antimony-free "Green" products are defined as those which contain <900ppm bromine, <900ppm chlorine (<1500ppm total Br + Cl) and <1000ppm antimony compounds.
  4. For packaging details, go to our website at <http://www.diodes.com/products/packages.html>.

## Marking Information

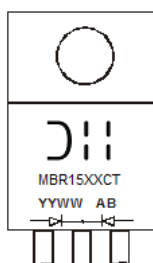

MBR15XXCT = Product Type Marking Code  
 AB = Foundry and Assembly Code  
 YYWW = Date Code Marking  
 YY = Last Two Digits of Year (ex: 15= 2015)  
 WW = Week (01 - 53)

**Maximum Ratings** (Per Leg) (@T<sub>A</sub> = +25°C, unless otherwise specified.)

Single phase, half wave, 60 Hz, resistive or inductive load.  
 For capacitive load, derate current by 20%.

Characteristic	Symbol	MBR 1545CT	MBR 1560CT	Unit
Peak Repetitive Reverse Voltage Working Peak Reverse Voltage DC Blocking Voltage (Note 7)	V <sub>RRM</sub> V <sub>RWM</sub> V <sub>R</sub>	45	60	V
RMS Reverse Voltage	V <sub>R(RMS)</sub>	31.5	42	V
Average Rectified Output Current (Note 5) @ T <sub>C</sub> = +125°C	I <sub>O</sub>	15		A
Non-Repetitive Peak Forward Surge Current 8.3ms Single Half Sine-Wave Superimposed on Rated Load	I <sub>FSM</sub>	150		A
Forward Voltage Drop @ I <sub>F</sub> = 15A, T <sub>C</sub> = +125°C @ I <sub>F</sub> = 7.5A, T <sub>C</sub> = +125°C @ I <sub>F</sub> = 15A, T <sub>C</sub> = +25°C	V <sub>FM</sub>	0.72 0.57 0.84	0.80 0.65 0.90	V
Peak Reverse Current at Rated DC Blocking Voltage (Note 7) @ T <sub>C</sub> = +25°C @ T <sub>C</sub> = +125°C	I <sub>RM</sub>	0.1 15	1.0 50	mA
Typical Total Capacitance (Note 6)	C <sub>T</sub>	300		pF
Typical Thermal Resistance Junction to Case (Note 5)	R <sub>θJC</sub>	1.7		°C/W
Operating and Storage Temperature Range	T <sub>J</sub> , T <sub>STG</sub>	-65 to +150		°C

- Notes:
- 5. Thermal resistance junction to case mounted on heatsink.
  - 6. Measured at 1.0MHz and applied reverse voltage of 4.0V DC.
  - 7. Short duration pulse test used to minimize self-heating.

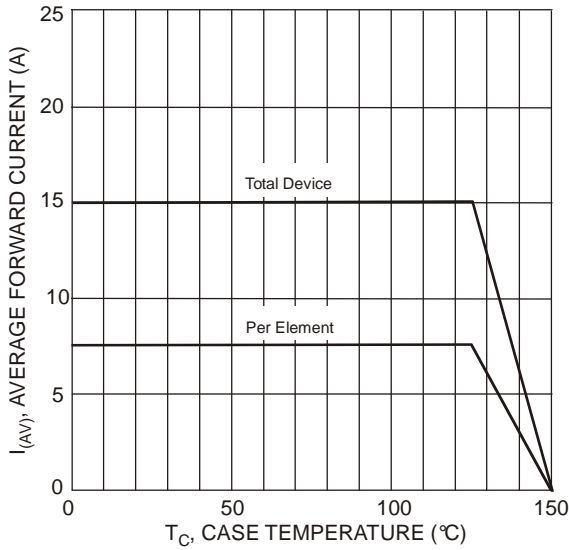

Fig. 1 Forward Current Derating Curve

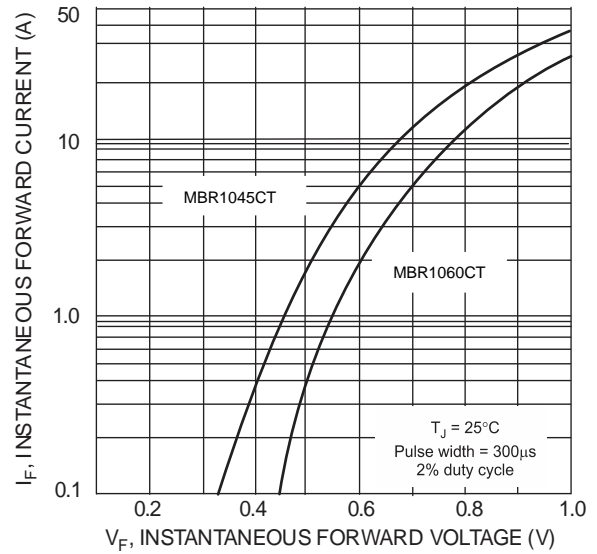

Fig. 2 Typical Forward Characteristics, (per Element)

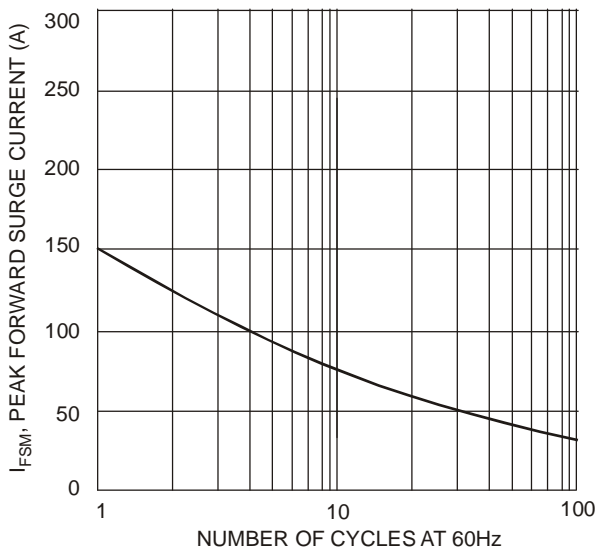

Fig. 3 Max Non-Repetitive Surge Current

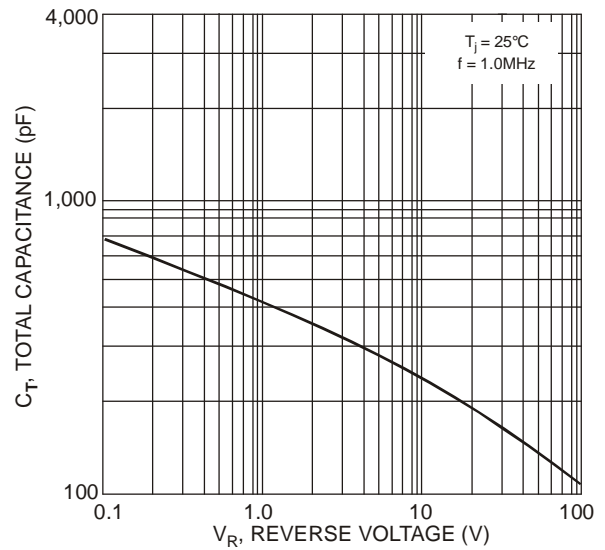

Fig. 4 Typical Total Capacitance (per element)

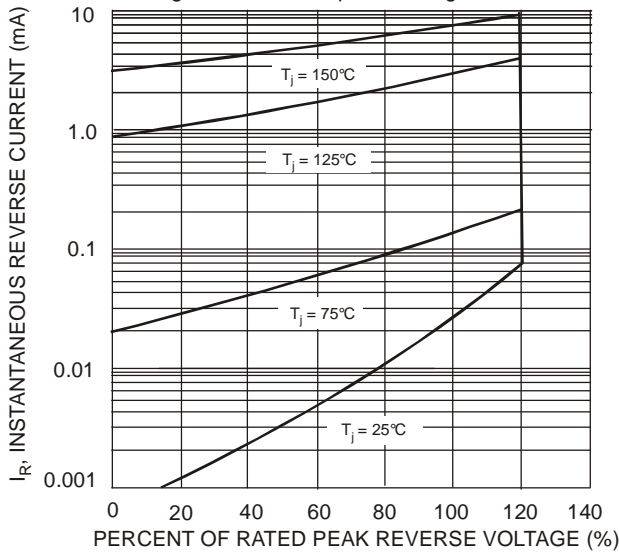
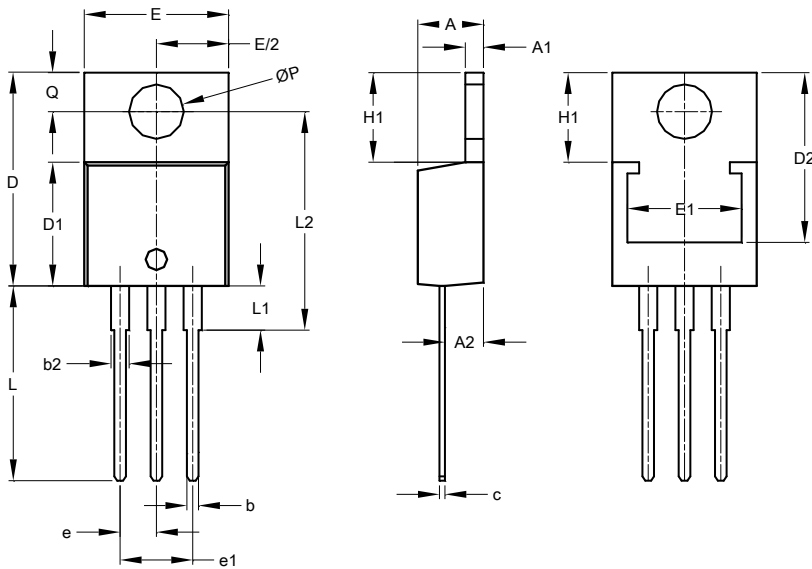

Fig. 5 Typical Reverse Characteristics, (per Element)

**Package Outline Dimensions**

Please see AP02002 at <http://www.diodes.com/datasheets/ap02002.pdf> for the latest version.



TO220AB			
Dim	Min	Max	Typ
A	3.56	4.82	—
A1	0.51	1.39	—
A2	2.04	2.92	—
b	0.39	1.01	0.81
b2	1.15	1.77	1.24
c	0.356	0.61	—
D	14.22	16.51	—
D1	8.39	9.01	—
D2	11.45	12.87	—
e	—	—	2.54
e1	—	—	5.08
E	9.66	10.66	—
E1	6.86	8.89	—
H1	5.85	6.85	—
L	12.70	14.73	—
L1	—	6.35	—
L2	15.80	16.20	16.00
P	3.54	4.08	—
Q	2.54	3.42	—
<b>All Dimensions in mm</b>			

**IMPORTANT NOTICE**

DIODES INCORPORATED MAKES NO WARRANTY OF ANY KIND, EXPRESS OR IMPLIED, WITH REGARDS TO THIS DOCUMENT, INCLUDING, BUT NOT LIMITED TO, THE IMPLIED WARRANTIES OF MERCHANTABILITY AND FITNESS FOR A PARTICULAR PURPOSE (AND THEIR EQUIVALENTS UNDER THE LAWS OF ANY JURISDICTION).

Diodes Incorporated and its subsidiaries reserve the right to make modifications, enhancements, improvements, corrections or other changes without further notice to this document and any product described herein. Diodes Incorporated does not assume any liability arising out of the application or use of this document or any product described herein; neither does Diodes Incorporated convey any license under its patent or trademark rights, nor the rights of others. Any Customer or user of this document or products described herein in such applications shall assume all risks of such use and will agree to hold Diodes Incorporated and all the companies whose products are represented on Diodes Incorporated website, harmless against all damages.

Diodes Incorporated does not warrant or accept any liability whatsoever in respect of any products purchased through unauthorized sales channel. Should Customers purchase or use Diodes Incorporated products for any unintended or unauthorized application, Customers shall indemnify and hold Diodes Incorporated and its representatives harmless against all claims, damages, expenses, and attorney fees arising out of, directly or indirectly, any claim of personal injury or death associated with such unintended or unauthorized application.

Products described herein may be covered by one or more United States, international or foreign patents pending. Product names and markings noted herein may also be covered by one or more United States, international or foreign trademarks.

This document is written in English but may be translated into multiple languages for reference. Only the English version of this document is the final and determinative format released by Diodes Incorporated.

**LIFE SUPPORT**

Diodes Incorporated products are specifically not authorized for use as critical components in life support devices or systems without the express written approval of the Chief Executive Officer of Diodes Incorporated. As used herein:

A. Life support devices or systems are devices or systems which:

1. are intended to implant into the body, or
2. support or sustain life and whose failure to perform when properly used in accordance with instructions for use provided in the labeling can be reasonably expected to result in significant injury to the user.

B. A critical component is any component in a life support device or system whose failure to perform can be reasonably expected to cause the failure of the life support device or to affect its safety or effectiveness.

Customers represent that they have all necessary expertise in the safety and regulatory ramifications of their life support devices or systems, and acknowledge and agree that they are solely responsible for all legal, regulatory and safety-related requirements concerning their products and any use of Diodes Incorporated products in such safety-critical, life support devices or systems, notwithstanding any devices- or systems-related information or support that may be provided by Diodes Incorporated. Further, Customers must fully indemnify Diodes Incorporated and its representatives against any damages arising out of the use of Diodes Incorporated products in such safety-critical, life support devices or systems.

Copyright © 2015, Diodes Incorporated

[www.diodes.com](http://www.diodes.com)