

# LE UW Q8WP

## OSRAM OSTAR® Projection Compact

Compact light source in SMT technology, glass window on top, ultra white, Lead (Pb) free - RoHS compliant

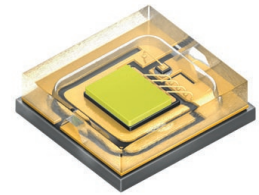

### Applications

- Architecture
- Architecture / Garden Lighting (LED & Laser)
- Mood Lighting
- Stage Lighting (LED & Laser)
- Street, Tunnel and Outdoor

### Features:

- Package: compact lightsource in SMT technology with glass window on top
- Chip technology: UX:3
- Typ. Radiation: 120°
- Color: Cx = 0.321, Cy = 0.327 acc. to CIE 1931 (• ultra white)
- Corrosion Robustness Class: 3B
- ESD: 2 kV acc. to ANSI/ESDA/JEDEC JS-001 (HBM, Class 2)

### Ordering Information

Type	Luminous Flux <sup>1)</sup> I <sub>F</sub> = 1400 mA Φ <sub>V</sub>	Ordering Code
LE UW Q8WP-NBPB-BQ	355 ... 710 lm	Q65112A4111

## Maximum Ratings

Parameter	Symbol		Values
Operating Temperature	$T_{op}$	min.	-40 °C
		max.	125 °C
Storage Temperature	$T_{stg}$	min.	-40 °C
		max.	125 °C
Junction Temperature	$T_j$	max.	150 °C
Forward Current $T_s = 25\text{ °C}$	$I_F$	min.	40 mA
		max.	5000 mA
Forward Current pulsed $D = 0.5 ; f = 120\text{ Hz} ; T_s = 25\text{ °C}$	$I_{F\text{ pulse}}$		6000 mA
Surge Current $t \leq 10\text{ }\mu\text{s} ; D = 0.5 ; T_s = 25\text{ °C}$	$I_{FS}$	max.	6000 mA
ESD withstand voltage acc. to ANSI/ESDA/JEDEC JS-001 (HBM, Class 2)	$V_{ESD}$		2 kV
Reverse current <sup>2)</sup>	$I_R$	max.	200 mA

## Characteristics

$I_F = 1400 \text{ mA}$ ;  $T_S = 25 \text{ °C}$

Parameter	Symbol		Values
Chromaticity Coordinate <sup>3)</sup>	$C_x$	typ.	0.321
	$C_y$	typ.	0.327
Viewing angle at 50% $I_V$	$2\phi$	typ.	130 °
Radiating surface	$A_{\text{color}}$	typ.	1.5 x 1.2 mm <sup>2</sup>
Partial Flux acc. CIE 127:2007 <sup>4)</sup> $I_F = 1400 \text{ mA}$	$\Phi_{E/V, 120^\circ}$	typ.	0.77
Forward Voltage <sup>5)</sup> $I_F = 1400 \text{ mA}$	$V_F$	min.	2.80 V
		typ.	2.95 V
		max.	3.50 V
Reverse voltage (ESD device)	$V_{R\text{ESD}}$	min.	45 V
Reverse voltage <sup>2)</sup> $I_R = 20 \text{ mA}$	$V_R$	max.	1.2 V
Real thermal resistance junction/solderpoint <sup>6)</sup>	$R_{\text{thJS real}}$	typ.	2.6 K / W
		max.	3.6 K / W
Electrical thermal resistance junction/solderpoint <sup>6)</sup> with efficiency $\eta_e = 30 \%$	$R_{\text{thJS elec.}}$	typ.	1.8 K / W
		max.	2.5 K / W

---

## Brightness Groups

Group	Luminous Flux <sup>1)</sup> $I_F = 1400 \text{ mA}$ min. $\Phi_V$	Luminous Flux <sup>1)</sup> $I_F = 1400 \text{ mA}$ max. $\Phi_V$
NB	355 lm	450 lm
PA	450 lm	560 lm
PB	560 lm	710 lm

### Chromaticity Coordinate Groups <sup>3)</sup>

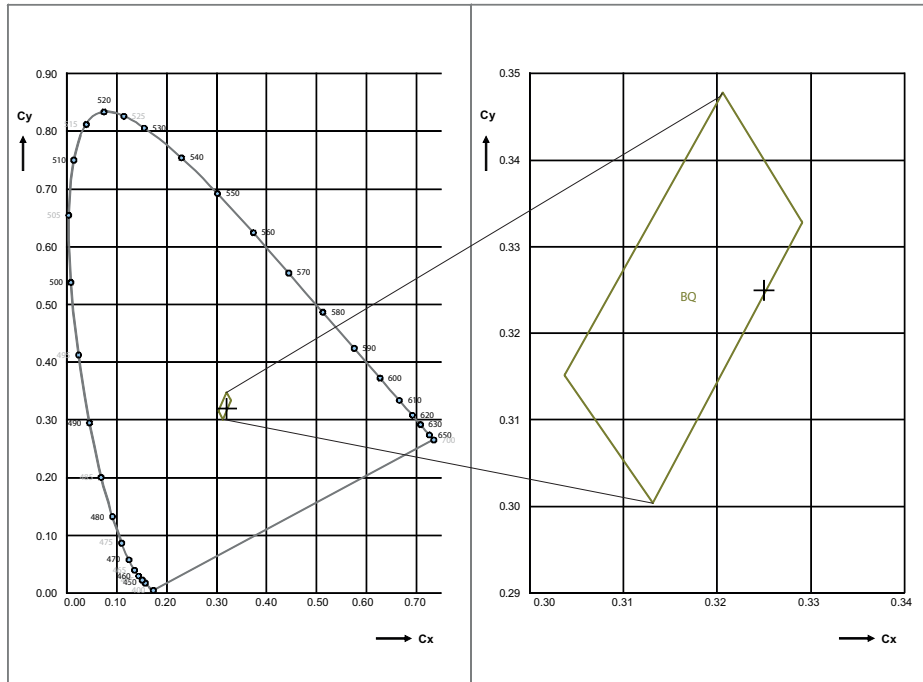

### Chromaticity Coordinate Groups <sup>3)</sup>

Group	Cx	Cy
BQ	0.3037	0.3151
	0.3206	0.3478
	0.3291	0.3328
	0.3132	0.3004

### Group Name on Label

**Example: NB-BQ**

Brightness

Color Chromaticity

NB

BQ

### Relative Spectral Emission <sup>4)</sup>

$\Phi_{rel} = f(\lambda); I_F = 1400 \text{ mA}; T_J = 25 \text{ }^\circ\text{C}$

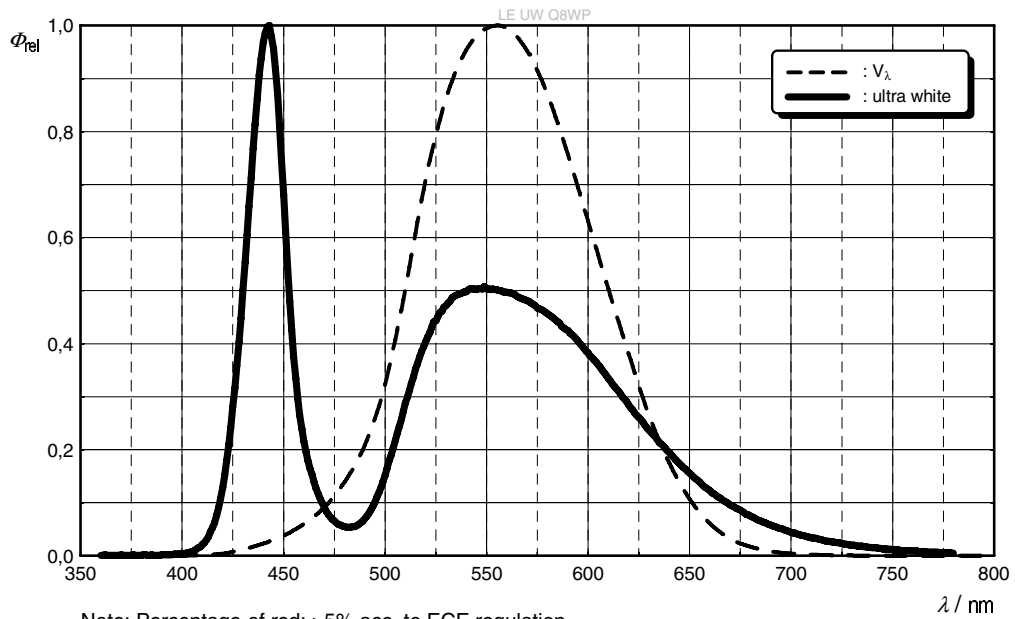

### Radiation Characteristics <sup>4)</sup>

$I_{rel} = f(\phi); T_J = 25 \text{ }^\circ\text{C}$

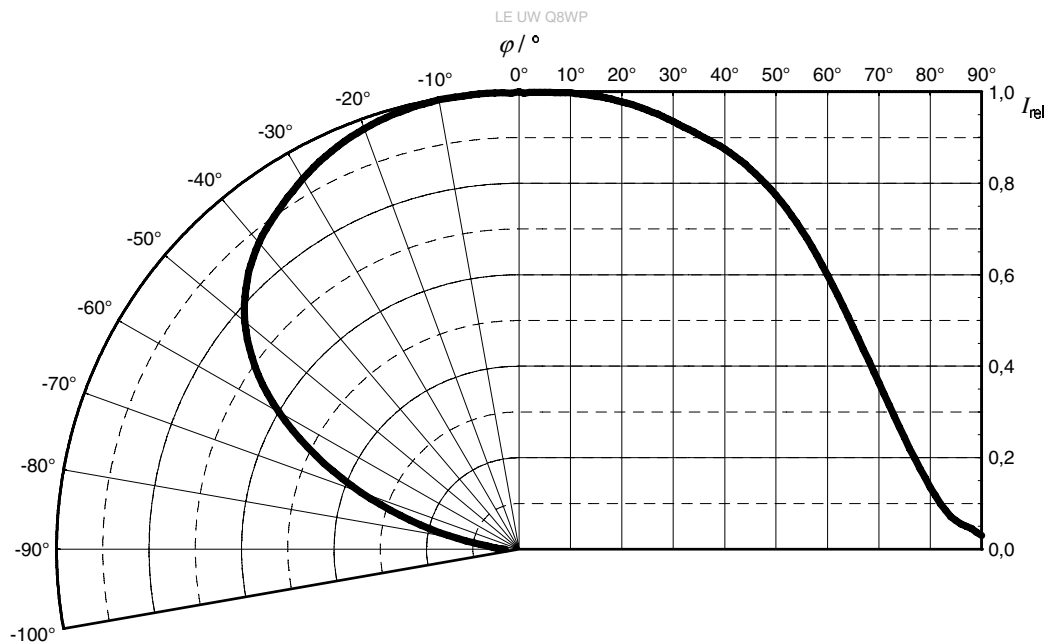

### Relative Partial Flux <sup>4)</sup>

$$\Phi_v(2\varphi)/\Phi_v(180^\circ) = f(\varphi); T_j = 25^\circ\text{C}$$

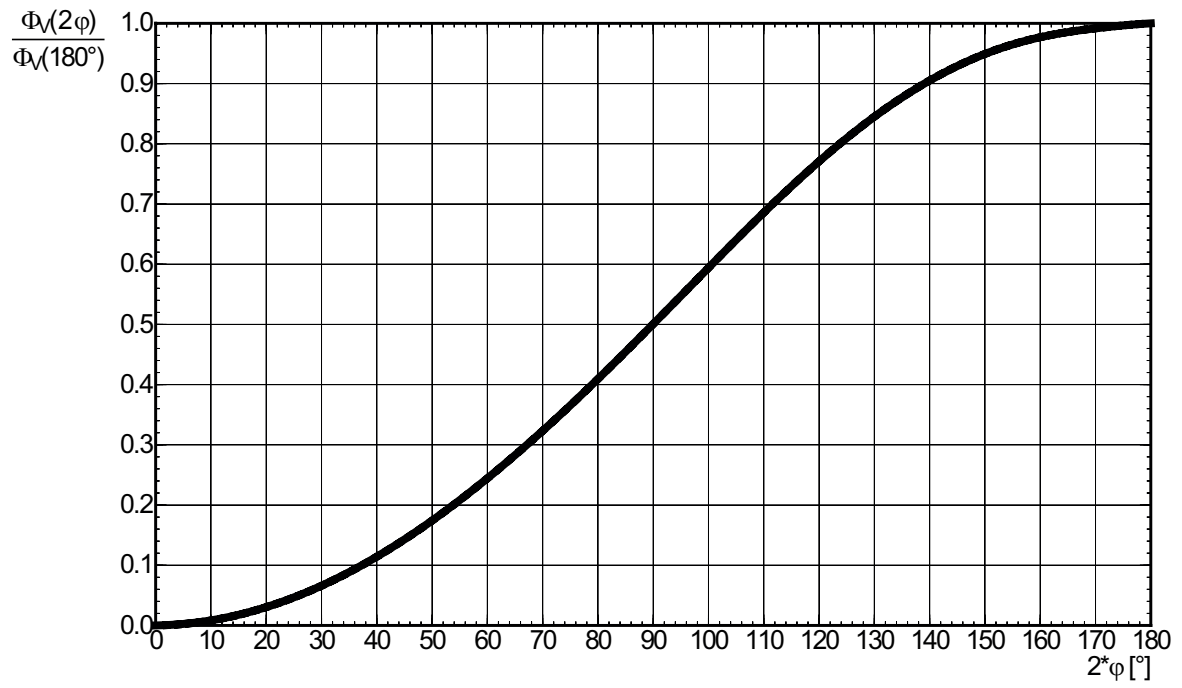

**Forward current** 4), 7)

$I_F = f(V_F); T_J = 25\text{ }^\circ\text{C}$

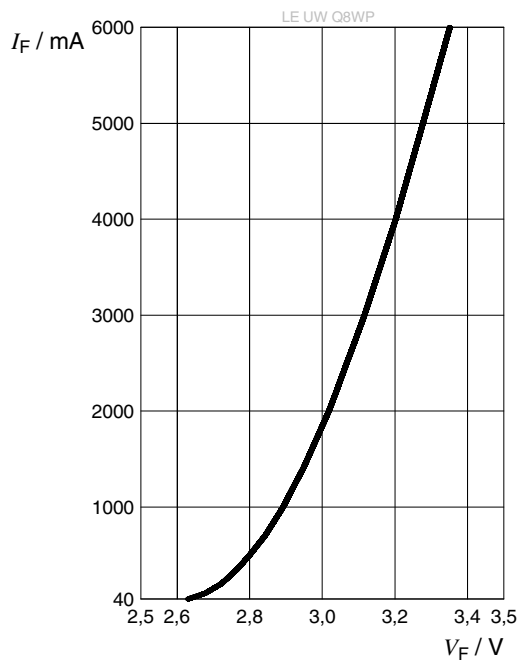

**Relative Luminous Flux** 4), 7)

$\Phi_V / \Phi_V(1400\text{ mA}) = f(I_F); T_J = 25\text{ }^\circ\text{C}$

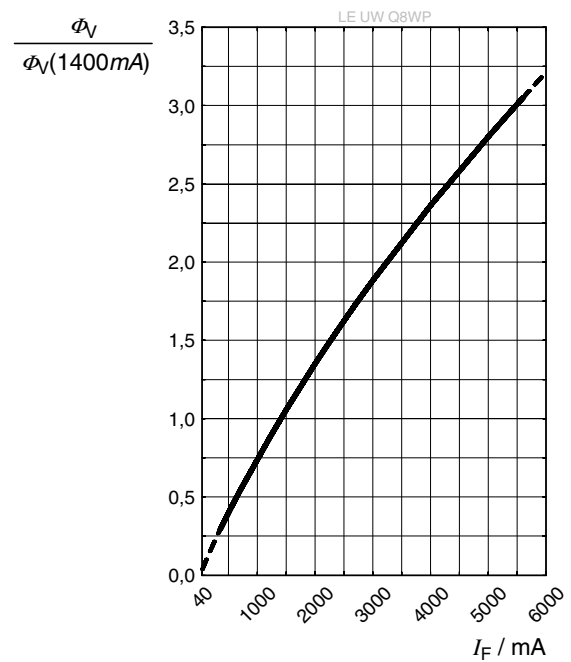

**Chromaticity Coordinate Shift** 4)

$\Delta Cx, \Delta Cy = f(I_F); T_J = 25\text{ }^\circ\text{C}$

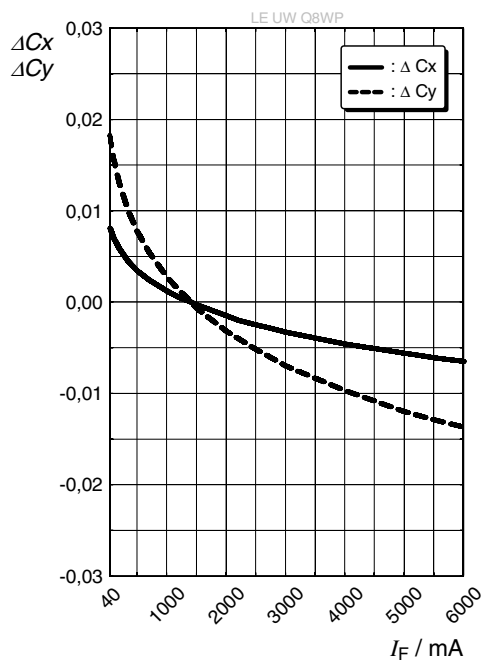



### Forward Voltage <sup>4)</sup>

$$\Delta V_F = V_F - V_F(25\text{ }^\circ\text{C}) = f(T_j); I_F = 1400\text{ mA}$$

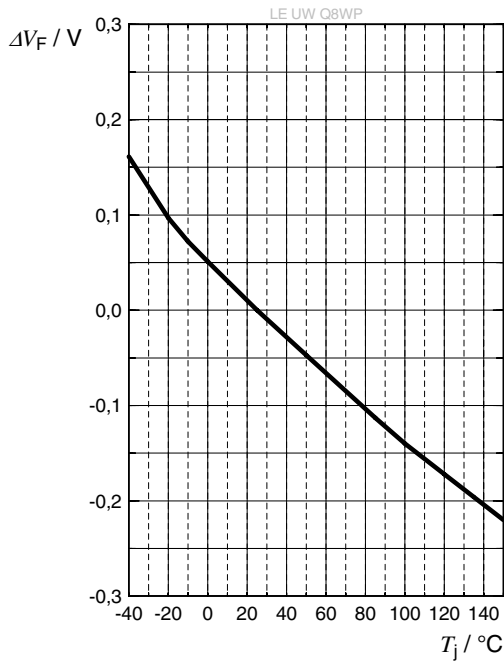

### Relative Luminous Flux <sup>4)</sup>

$$\Phi_v / \Phi_v(25\text{ }^\circ\text{C}) = f(T_j); I_F = 1400\text{ mA}$$

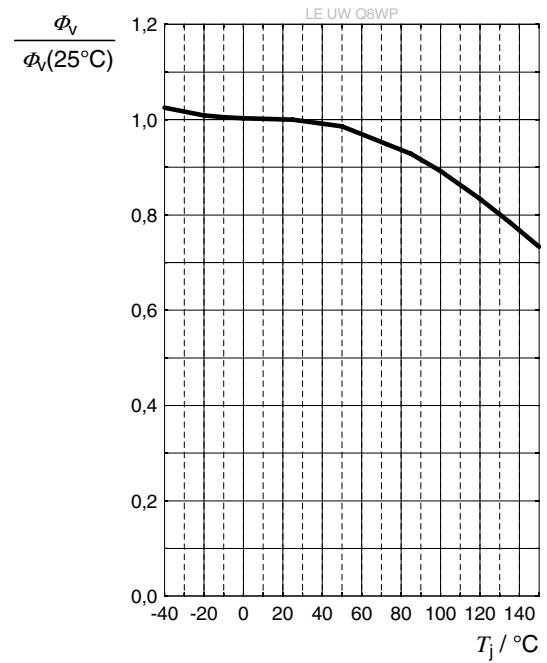

### Chromaticity Coordinate Shift <sup>4)</sup>

$$\Delta C_x, \Delta C_y = f(T_j); I_F = 1400\text{ mA}$$

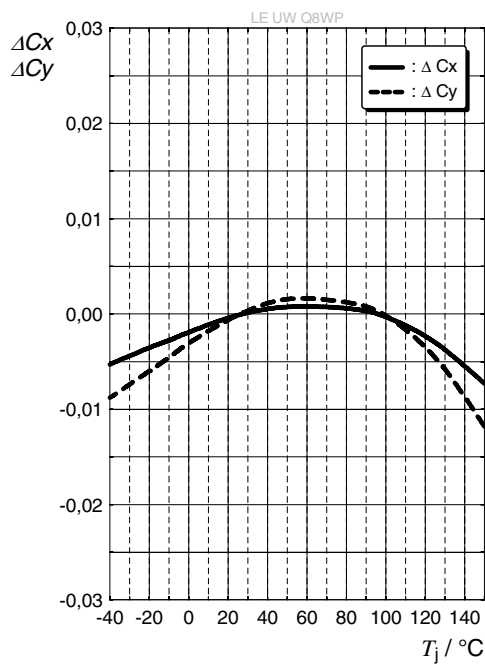

### Max. Permissible Forward Current

$I_F = f(T)$

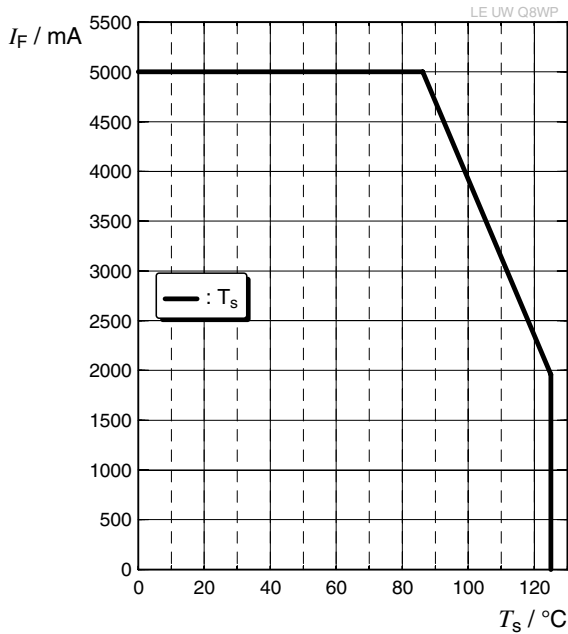

### Permissible Pulse Handling Capability

$I_F = f(t_p)$ ; D: Duty cycle

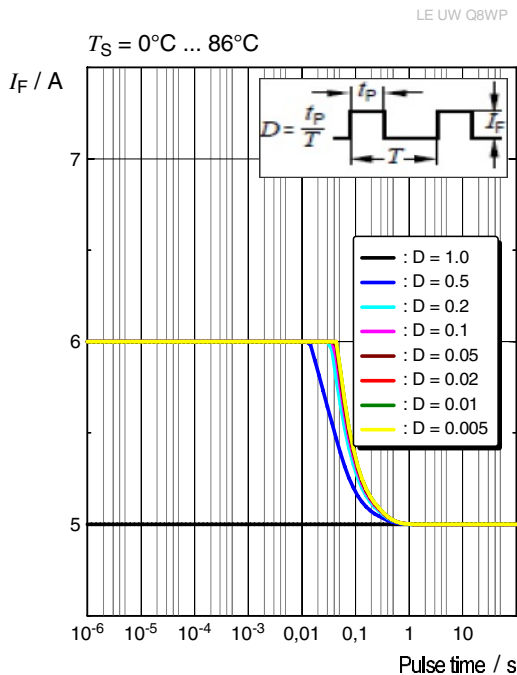

### Permissible Pulse Handling Capability

$I_F = f(t_p)$ ; D: Duty cycle

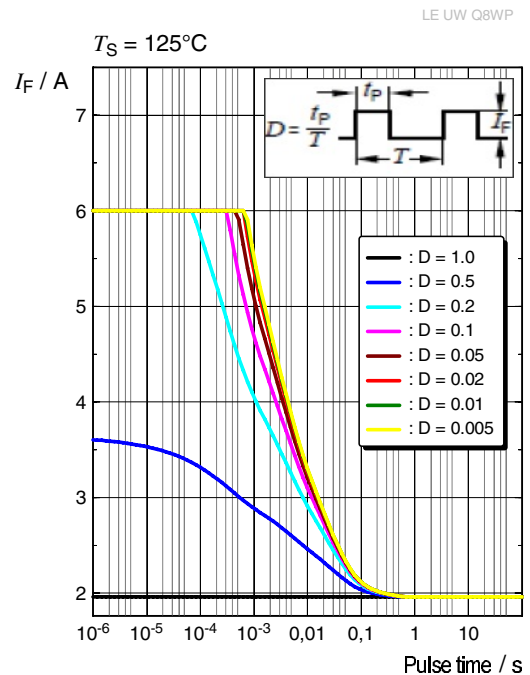

**Dimensional Drawing** <sup>8)</sup>

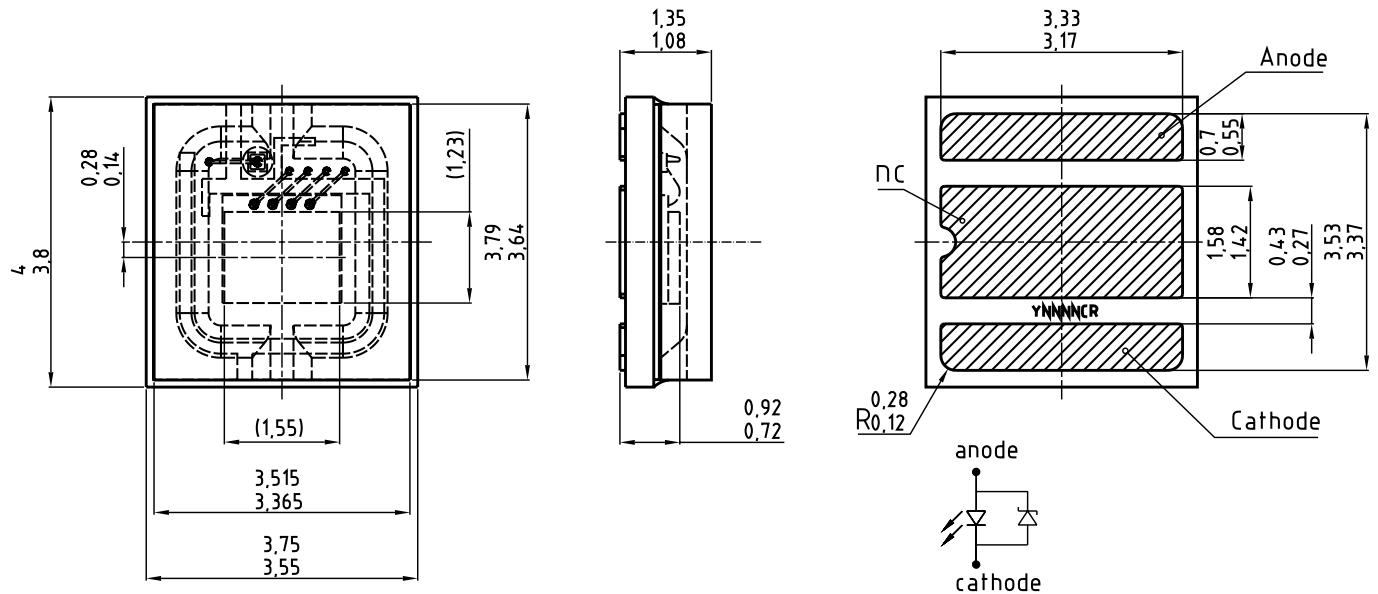

C63062-A4193-A1-03

**Further Information:**

**Approximate Weight:** 48.0 mg

**Corrosion test:** Class: 3B  
 Test condition: 40°C / 90 % RH / 15 ppm H<sub>2</sub>S / 14 days (stricter than IEC 60068-2-43)

**ESD advice:** The device is protected by ESD device which is connected in parallel to the Chip.

### Recommended Solder Pad <sup>8)</sup>

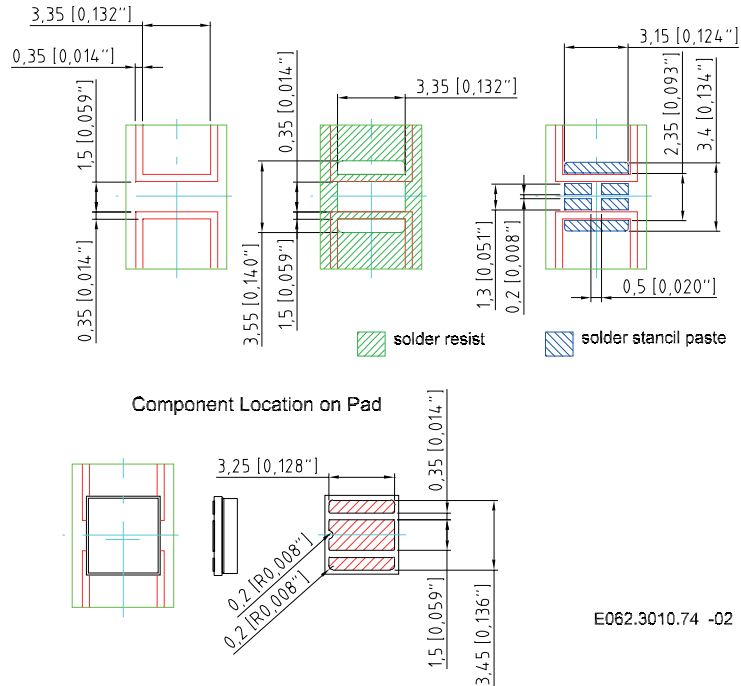

### Recommended Solder Pad <sup>8)</sup>

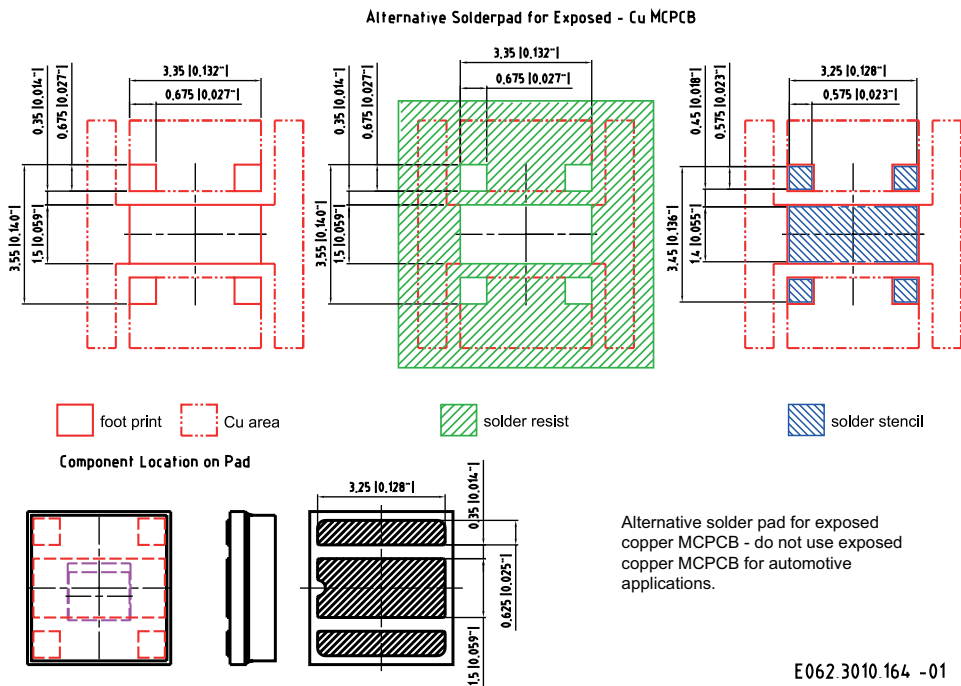

Exposed Copper MCPCB must not exceed thickness of 1mm. For superior solder joint connectivity results we recommend soldering under standard nitrogen atmosphere. Package not suitable for any kind of wet cleaning or ultrasonic cleaning.

## Reflow Soldering Profile

Product complies to MSL Level 2 acc. to JEDEC J-STD-020E



Profile Feature	Symbol	Pb-Free (SnAgCu) Assembly			Unit
		Minimum	Recommendation	Maximum	
Ramp-up rate to preheat <sup>*)</sup> 25 °C to 150 °C			2	3	K/s
Time $t_s$ $T_{Smin}$ to $T_{Smax}$	$t_s$	60	100	120	s
Ramp-up rate to peak <sup>*)</sup> $T_{Smax}$ to $T_p$			2	3	K/s
Liquidus temperature	$T_L$		217		°C
Time above liquidus temperature	$t_L$		80	100	s
Peak temperature	$T_p$		245	260	°C
Time within 5 °C of the specified peak temperature $T_p - 5$ K	$t_p$	10	20	30	s
Ramp-down rate* $T_p$ to 100 °C			3	6	K/s
Time 25 °C to $T_p$				480	s

All temperatures refer to the center of the package, measured on the top of the component

\* slope calculation  $DT/Dt$ :  $Dt$  max. 5 s; fulfillment for the whole T-range

**Taping** <sup>8)</sup>

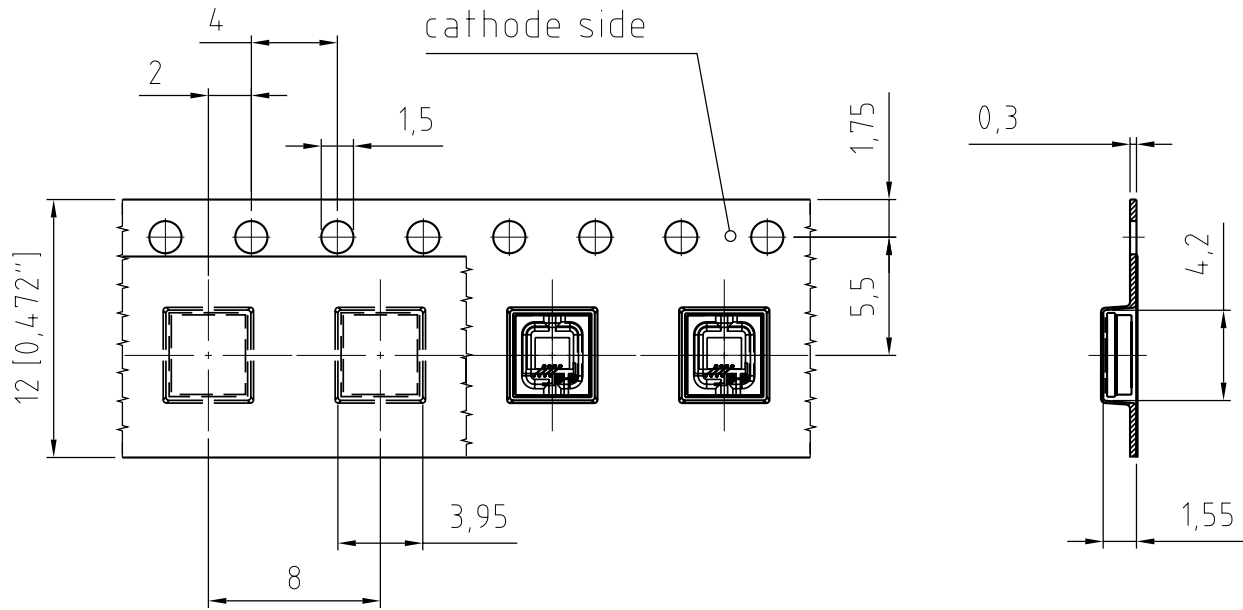

C63062-A4193-B7 -04

**Tape and Reel** <sup>9)</sup>



**Reel Dimensions**

A	W	N <sub>min</sub>	W <sub>1</sub>	W <sub>2max</sub>	Pieces per PU
180 mm	12 + 0.3 / - 0.1 mm	60 mm	12.4 + 2 mm	18.4 mm	1000

### Barcode-Product-Label (BPL)

**OSRAM Opto Semiconductors** LX XXXX BIN1: XX-XX-X-XXX-X

RoHS Compliant

(6P) BATCH NO: 1234567890

(1T) LOT NO: 1234567890 (9D) D/C: 1234

(X) PROD NO: 123456789(Q)QTY: 9999 (G) GROUP: XX-XX-X-X

ML Temp ST  
X XXX °C X

Pack: RXX  
DEMY XXX  
X\_X123\_1234.1234 X

The diagram shows a rectangular label with rounded corners. It contains the OSRAM logo and product name at the top left. To the right are fields for 'LX XXXX' and 'BIN1: XX-XX-X-XXX-X'. Below this is 'RoHS Compliant'. The main body of the label is divided into three horizontal sections, each with a barcode and associated text: (6P) BATCH NO: 1234567890, (1T) LOT NO: 1234567890 (9D) D/C: 1234, and (X) PROD NO: 123456789(Q)QTY: 9999 (G) GROUP: XX-XX-X-X. To the right of the second section is a 'No moisture' symbol (a circle with a diagonal line and three droplets) and 'ML Temp ST X XXX °C X'. Below that is a 'Pack: RXX', 'DEMY XXX', and 'X\_X123\_1234.1234 X'. A square QR code is located on the right side of the label.

OHA04563

### Dry Packing Process and Materials <sup>8)</sup>



OHA00539

Moisture-sensitive product is packed in a dry bag containing desiccant and a humidity card according JEDEC-STD-033.



## Type Designation System

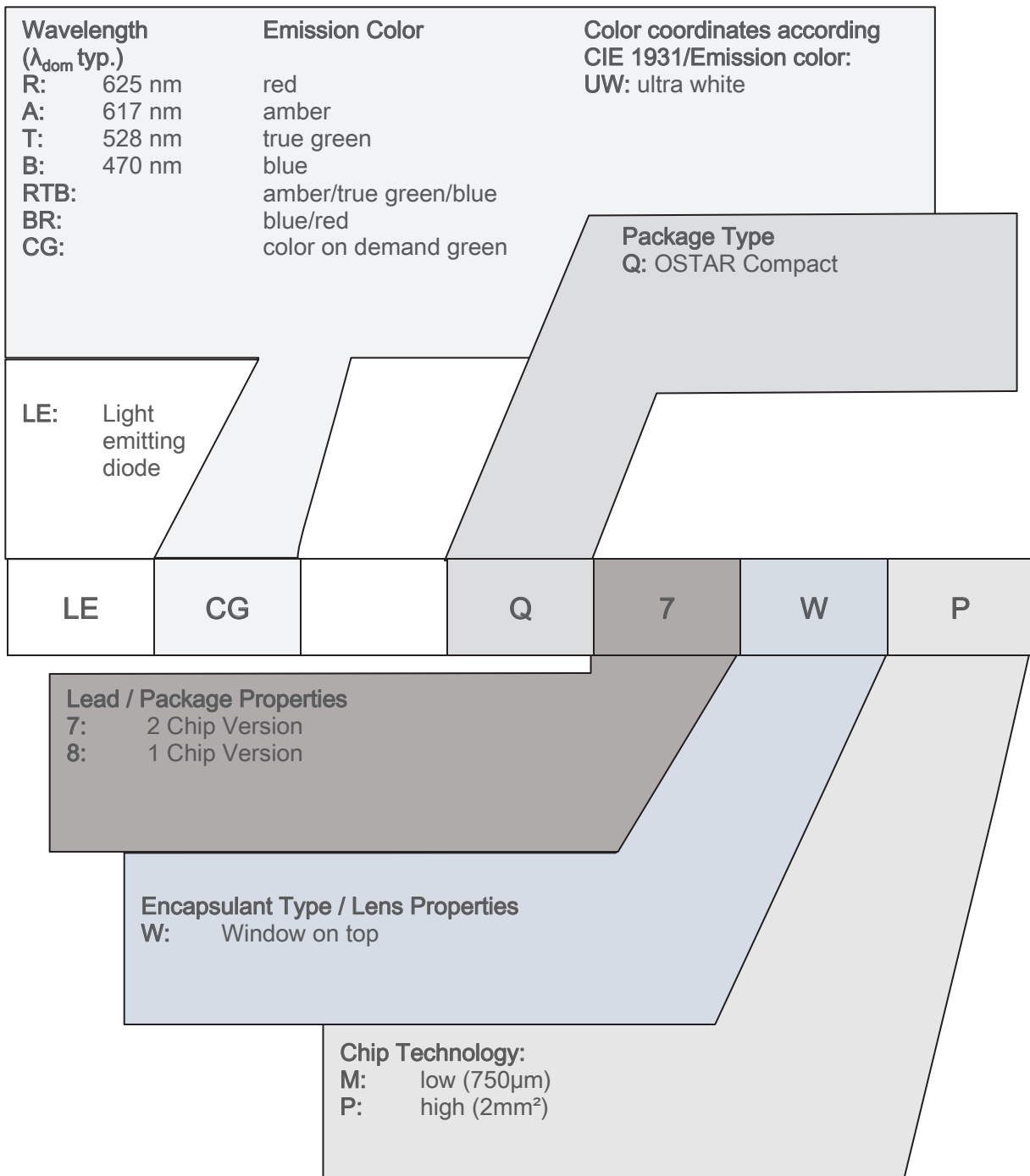

## Notes

The evaluation of eye safety occurs according to the standard IEC 62471:2006 (photo biological safety of lamps and lamp systems). Within the risk grouping system of this IEC standard, the device specified in this data sheet falls into the class **moderate risk (exposure time 0.25 s)**. Under real circumstances (for exposure time, conditions of the eye pupils, observation distance), it is assumed that no endangerment to the eye exists from these devices. As a matter of principle, however, it should be mentioned that intense light sources have a high secondary exposure potential due to their blinding effect. When looking at bright light sources (e.g. headlights), temporary reduction in visual acuity and afterimages can occur, leading to irritation, annoyance, visual impairment, and even accidents, depending on the situation.

Subcomponents of this device contain, in addition to other substances, metal filled materials including silver. Metal filled materials can be affected by environments that contain traces of aggressive substances. Therefore, we recommend that customers minimize device exposure to aggressive substances during storage, production, and use. Devices that showed visible discoloration when tested using the described tests above did show no performance deviations within failure limits during the stated test duration. Respective failure limits are described in the IEC60810.

For further application related information please visit [www.osram-os.com/appnotes](http://www.osram-os.com/appnotes)

## Disclaimer

### **Attention please!**

The information describes the type of component and shall not be considered as assured characteristics. Terms of delivery and rights to change design reserved. Due to technical requirements components may contain dangerous substances.

For information on the types in question please contact our Sales Organization.

If printed or downloaded, please find the latest version on the OSRAM OS website.

### **Packing**

Please use the recycling operators known to you. We can also help you – get in touch with your nearest sales office. By agreement we will take packing material back, if it is sorted. You must bear the costs of transport. For packing material that is returned to us unsorted or which we are not obliged to accept, we shall have to invoice you for any costs incurred.

### **Product and functional safety devices/applications or medical devices/applications**

OSRAM OS components are not developed, constructed or tested for the application as safety relevant component or for the application in medical devices.

OSRAM OS products are not qualified at module and system level for such application.

In case buyer – or customer supplied by buyer – considers using OSRAM OS components in product safety devices/applications or medical devices/applications, buyer and/or customer has to inform the local sales partner of OSRAM OS immediately and OSRAM OS and buyer and /or customer will analyze and coordinate the customer-specific request between OSRAM OS and buyer and/or customer.

---

## Glossary

- 1) **Brightness:** Brightness values are measured during a current pulse of typically 25 ms, with an internal reproducibility of  $\pm 8\%$  and an expanded uncertainty of  $\pm 11\%$  (acc. to GUM with a coverage factor of  $k = 3$ ).
- 2) **Reverse Operation:** This product is intended to be operated applying a forward current within the specified range. Applying any continuous reverse bias or forward bias below the voltage range of light emission shall be avoided because it may cause migration which can change the electro-optical characteristics or damage the LED.
- 3) **Chromaticity coordinate groups:** Chromaticity coordinates are measured during a current pulse of typically 25 ms, with an internal reproducibility of  $\pm 0.005$  and an expanded uncertainty of  $\pm 0.01$  (acc. to GUM with a coverage factor of  $k = 3$ ).
- 4) **Typical Values:** Due to the special conditions of the manufacturing processes of semiconductor devices, the typical data or calculated correlations of technical parameters can only reflect statistical figures. These do not necessarily correspond to the actual parameters of each single product, which could differ from the typical data and calculated correlations or the typical characteristic line. If requested, e.g. because of technical improvements, these typ. data will be changed without any further notice.
- 5) **Forward Voltage:** The forward voltage is measured during a current pulse of typically 8 ms, with an internal reproducibility of  $\pm 0.05\text{ V}$  and an expanded uncertainty of  $\pm 0.1\text{ V}$  (acc. to GUM with a coverage factor of  $k = 3$ ).
- 6) **Thermal Resistance:**  $R_{th\ max}$  is based on statistic values ( $6\sigma$ ).
- 7) **Characteristic curve:** In the range where the line of the graph is broken, you must expect higher differences between single devices within one packing unit.
- 8) **Tolerance of Measure:** Unless otherwise noted in drawing, tolerances are specified with  $\pm 0.1$  and dimensions are specified in mm.
- 9) **Tape and Reel:** All dimensions and tolerances are specified acc. IEC 60286-3 and specified in mm.

## Revision History

Version	Date	Change
1.4	2020-06-04	Schematic Transportation Box Dimensions of Transportation Box

---

Published by OSRAM Opto Semiconductors GmbH EU RoHS and China RoHS compliant product  
Leibnizstraße 4, D-93055 Regensburg  
www.osram-os.com © All Rights Reserved.



此产品符合欧盟 RoHS 指令的要求；  
按照中国的相关法规和标准，不含有毒有害物质或元素。