

● Description

The KT0481 series fast speed photo coupler contains a LED and photo detector with built-in Schmitt trigger to provide logic-compatible waveforms, eliminating the need for additional wave shaping. The totem pole output eliminates the need for a pull up resistor and allows for direct drive Intelligent Power Module or gate drive. Minimized propagation delay difference between devices makes these photo couplers excellent solutions for improving inverter efficiency through reduced switching dead time.

● Features

1. Inverter output type (totem pole output)
2. Truth Table Guaranteed: VCC from 4.5V to 30V
3. Performance Specified for Common IPM Applications Over Industrial Temperature Range.
4. Short Maximum Propagation Delays
5. Minimized Pulse Width Distortion (PWD)
6. Very High Common Mode Rejection (CMR)
7. Hysteresis
8. Safety standards
 - UL-approved: UL1577, File No.E508942
 - VDE-approved: DIN EN IEC 60747-5-5 (VDE 0884-5):2021-10; EN IEC 60747- 5-5:2020, Certificate No.40054662
 - CQC-approved: GB4943.1-2011, Certificate No.CQC21001290290

● Applications

- IPM Interface Isolation
- Isolated IGBT/MOSFET Gate Drive
- AC and Brushless DC Motor Drives
- Industrial Inverters
- General Digital Isolation

● Truth Table

LED	OUT
ON	L
OFF	H

Note: A 0.1μF bypass capacitor must be connected between Pin 4 and 6.

● Schematic

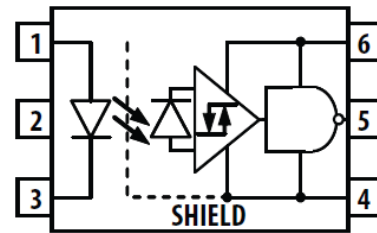

- | | |
|------------|------------------------|
| 1. Anode | 4. GND |
| 2. NA | 5. Vo (Voltage Output) |
| 3. Cathode | 6. Vcc |

● **Outside Dimension**

Surface Mount Lead Forming

Unit : mm

1. P Type

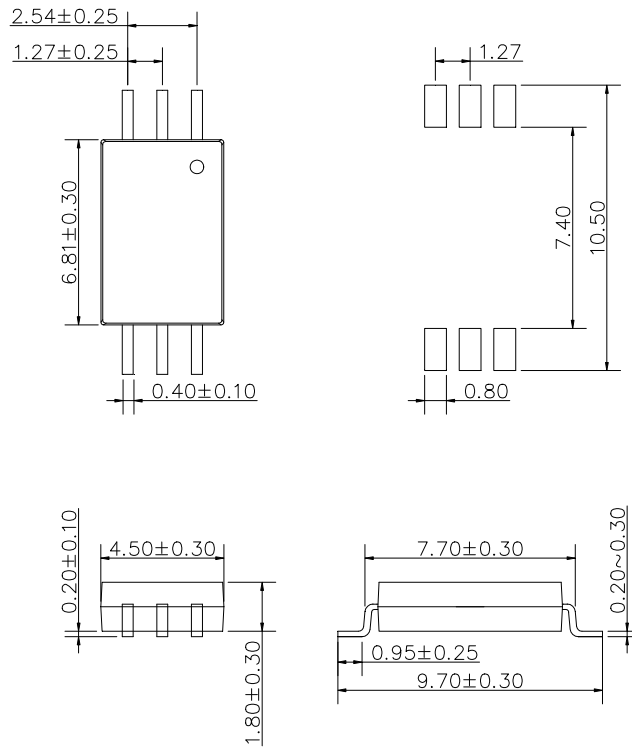

2. W Type

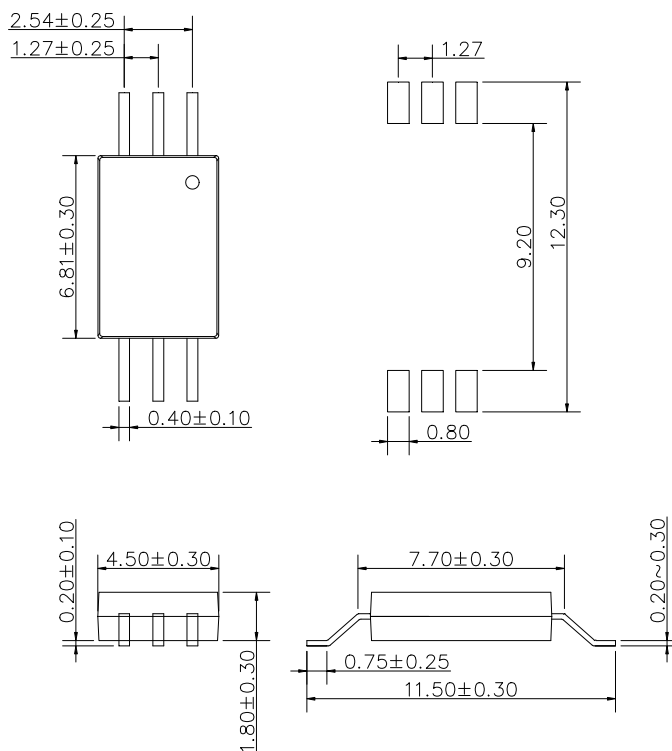

● Device Marking



Notes:

COSMO
0481
YWW
V

Y: Year code / WW: Week code
V or None : VDE option

● Absolute Maximum Ratings

(Ta = 25°C)

Parameter		Symbol	Rating	Unit
Input	Forward current	I_F	20	mA
	Peak transient forward current (Note 1)	I_{FPT}	1	A
	Reverse voltage	V_R	5	V
Output	Output current	I_O	50	mA
	Output voltage	V_O	35	V
	Supply Voltage	V_{CC}	35	V
Junction temperature		T_j	125	°C
Storage Temperature		T_{stg}	-55~125	°C
Operating Temperature		T_{opr}	-40~110	°C
Total Package Power Dissipation		P_T	145	mW
Lead soldering temperature(10s) (Note 2)		T_{sol}	260	°C
Isolation voltage (AC, 1min., R.H ≤ 60%) (Note 3)		BVs	3750	Vrms
Input-Output Resistance ($V_{I-O} = 500V$ DC) (Note 3)		R_{I-O}	10^{12}	Ω

Note 1: Pulse width $P_w \leq 1\mu s, 300pps$.

Note 2: It is 2 mm or more from a lead root.

Note 3: Device is considered as a two terminal device: Pin1,2 and 3 shorted together, and pins 4,5 and 6 shorted together.

● Recommend Operation Conditions

Parameter	Symbol	Min.	Max.	Unit
Operating Temperature	T_A	-40	110	°C
Supply Voltage ¹	V_{CC}	4.5	30	V
Input Current (ON) ²	$I_{F(ON)}$	1.6	5	mA
Input Voltage (OFF)	$V_{F(OFF)}$		0.8	V

Note 1: Detector requires a VCC of 4.5 V or higher for stable operation as output might be unstable if VCC is lower than 4.5 V. Be sure to check the power ON/OFF operation other than the supply current.

Note 2: The initial switching threshold is 1.6 mA or less. It is recommended that 2.2 mA be used to permit at least a 20% LED degradation guard band.

● Electrical Characteristics

Specified over recommended temperature ($T_A = -40^{\circ}\text{C}$ to $+110^{\circ}\text{C}$, $+4.5\text{V} \leq V_{CC} \leq 30\text{V}$), $I_F(\text{ON}) = 1.6\text{mA}$ to 5mA , $V_F(\text{OFF}) = 0\text{V}$ to 0.8V , unless otherwise specified. All typicals at $T_A = 25^{\circ}\text{C}$.

Parameter	Symbol	Test Condition	Min.	Typ.	Max.	Unit	
Input Forward Voltage	V_F	$I_F=10\text{mA}$	1.6	2.0	2.4	V	
Input Forward Voltage Temperature Coefficient	$\Delta V_F / \Delta T$	$I_F=10\text{mA}$	-	-1.24	-	mV/ $^{\circ}\text{C}$	
Input Reverse Voltage	BV_R	$I_R = 10\mu\text{A}$	5	-	-	V	
Input Threshold Current (High to Low)	I_{FHL}	$V_{CC} = 30\text{V}$, $V_O < 5\text{V}$	-	0.25	1.5	mA	
Input Threshold Voltage (High to Low)	V_{FHL}	$V_{CC} = 30\text{V}$, $V_O > 5\text{V}$	0.8	-	-	V	
Input Capacitance ²	C_{IN}	$f = 1\text{MHz}$, $V_F = 0\text{V}$	-	60	-	pF	
Supply Current	High Level	I_{CCH}	$V_{CC} = 5.5\text{V}$, $V_F = 0\text{V}$, $I_O = 0\text{mA}$	-	-	3.0	mA
		I_{CCH}	$V_{CC} = 30\text{V}$, $V_F = 0\text{V}$, $I_O = 0\text{mA}$	-	1.9	3.0	
	Low Level	I_{CCL}	$V_{CC} = 5.5\text{V}$, $I_F = 5\text{mA}$, $I_O = 0\text{mA}$	-	-	3.0	
		I_{CCL}	$V_{CC} = 30\text{V}$, $I_F = 5\text{mA}$, $I_O = 0\text{mA}$	-	2.0	3.0	
Output current ¹	High level	I_{OH}	$V_{CC} = 5.5\text{V}$, $V_F = 0\text{V}$, $V_O = \text{GND}$	-	-	-160	mA
		I_{OH}	$V_{CC} = 20\text{V}$, $V_F = 0\text{V}$, $V_O = \text{GND}$	-	-	-200	
	Low level	I_{OL}	$V_O = V_{CC} = 5.5\text{V}$, $I_F = 5\text{mA}$	160	-	-	
		I_{OL}	$V_O = V_{CC} = 20\text{V}$, $I_F = 5\text{mA}$	200	-	-	
Output voltage	High level	V_{OH}	$I_{OL} = -6.5\text{mA}$	$V_{CC} - 0.5$	$V_{CC} - 0.05$	-	V
	Low level	V_{OL}	$I_{OL} = 6.5\text{mA}$	-	0.09	0.5	

Note 1: Duration of output short circuit time should not exceed 10 μs .

Note 2: Input capacitance is measured between pin 1 and pin 3.

● Switching Characteristics

Over recommended operating conditions $T_A = -40^\circ\text{C}$ to 105°C , $V_{CC} = +4.5\text{V}$ to 30V , $I_F(\text{ON}) = 1.6\text{mA}$ to 5mA , $V_F(\text{OFF}) = 0\text{V}$ to 0.8V , unless otherwise specified. All typicals at $T_A = 25^\circ\text{C}$.

Parameter	Symbol	Test Condition	Min.	Typ.	Max.	Unit
Propagation Delay Time to Output Low Level	t_{PHL}	$f = 10\text{kHz}$, Duty Cycle = 50% $I_F = 2\text{mA}$, $V_{CC} = 30\text{V}$	-	90	220	ns
Propagation Delay Time to Output High Level	t_{PLH}		-	110	220	
Pulse Width Distortion	PWD		-	20	120	
Propagation Delay Difference Between Any Two Parts	PDD ($t_{\text{PHL}} - t_{\text{PLH}}$)		-200	-	+200	
Rise Time	t_r		-	6	-	
Fall Time	t_f		-	7	-	
Common mode transient immunity at high level output	$ C_{\text{MH}} $	$V_F = 0\text{V}$ $V_{CC} = 5\text{V}$, $T_A = 25^\circ\text{C}$, $V_{\text{CM}} = 1.5\text{KV}$	20	-	-	KV / μs
Common mode transient immunity at low level output	$ C_{\text{ML}} $	$I_F = 4\text{mA}$ $V_{CC} = 5\text{V}$, $T_A = 25^\circ\text{C}$, $V_{\text{CM}} = 1.5\text{KV}$	20	-	-	KV / μs

Note 1: The t_{PLH} propagation delay is measured from the 50% point on the leading edge of the input pulse to the 1.3 V point on the leading edge of the output pulse. The t_{PHL} propagation delay is measured from the 50% point on the trailing edge of the input pulse to the 1.3 V point on the trailing edge of the output pulse.

Note 2: Pulse Width Distortion (PWD) is defined as $|t_{\text{PHL}} - t_{\text{PLH}}|$ for any given device.

Note 3: The difference of t_{PLH} and t_{PHL} between any two devices under the same test condition.

Note 4: C_{MH} is the maximum slew rate of the common mode voltage that can be sustained with the output voltage in the logic high state, $V_O > 2.0\text{V}$. C_{ML} is the maximum slew rate of the common mode voltage that can be sustained with the output voltage in the logic low state, $V_O < 0.8\text{V}$. Note: Equal value split resistors ($R_{\text{in}}/2$) must be used at both ends of the LED.

● **Test Circuit**

Propagation delay time t_{PLH} 、 t_{PHL} 、and rise time t_r , fall time t_f

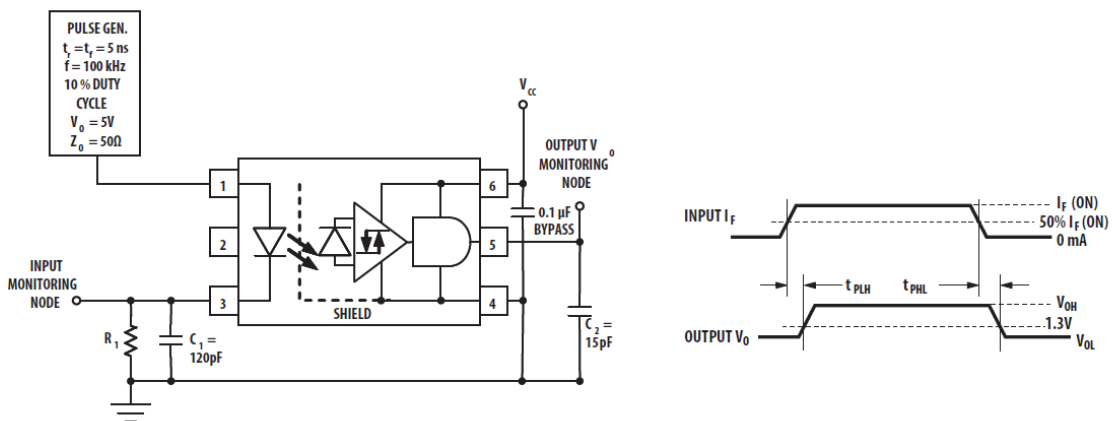

Common Mode Transient Immunity Test Circuit and Typical Waveforms

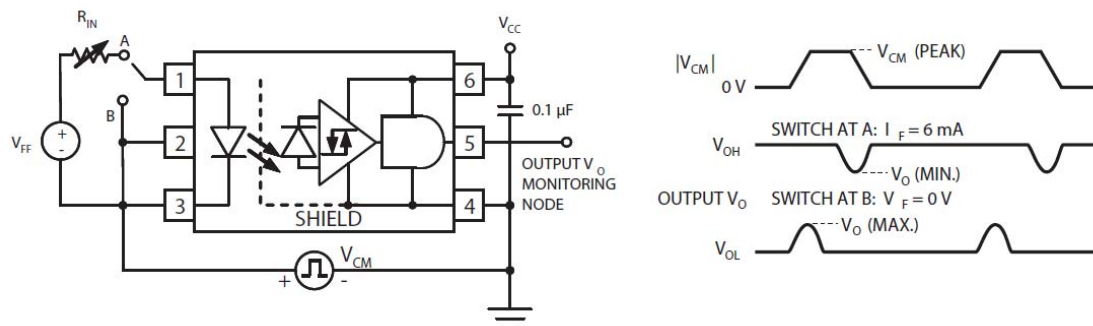

* $C_{ML}(C_{MH})$ is the maximum rate of rise (fall) of the common mode voltage that can be sustained with the output voltage in the low (high) state.

● Characteristics curves

Fig.1 VOL vs. Temperature

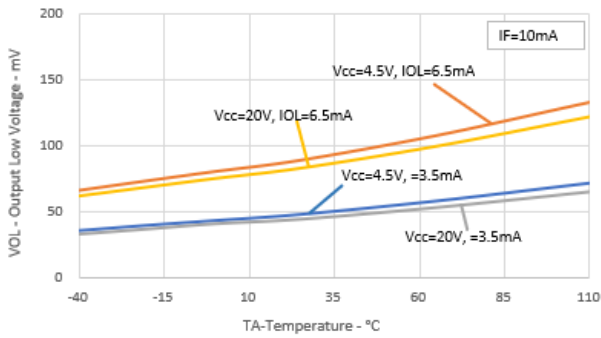

Fig.2 VOH vs. Temperature

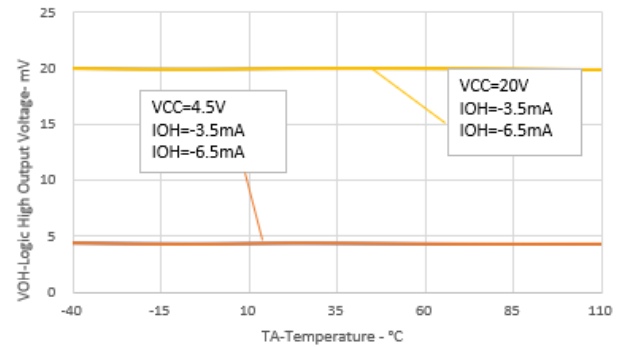

Fig.3 I_{FLH} Hysteresis

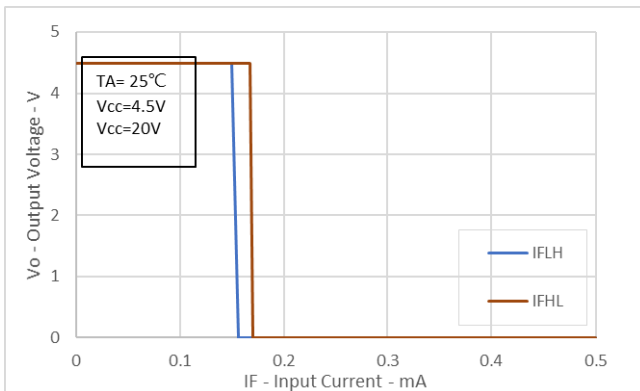

Fig.4 I_{FLH} vs. Temperature

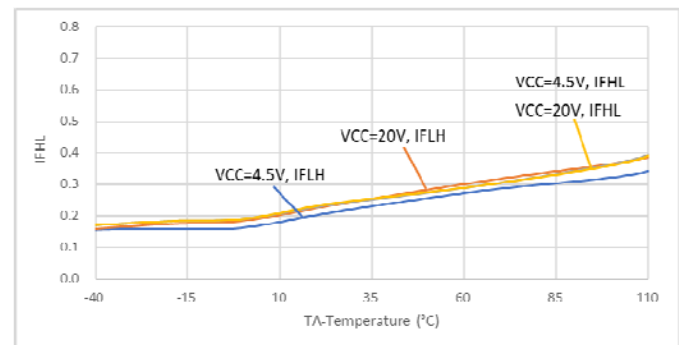

Fig.5 Input Current vs. Voltage

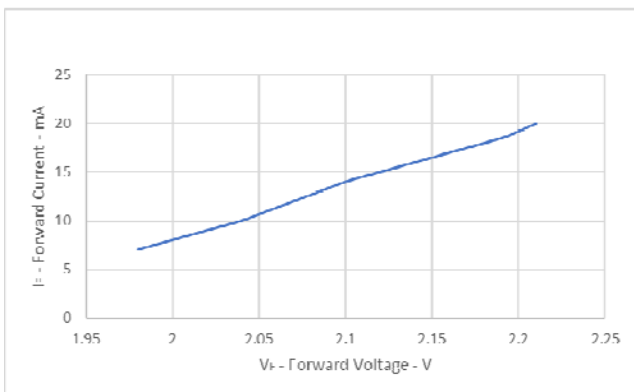

Fig. 6 Supply Voltage vs. Output Voltage

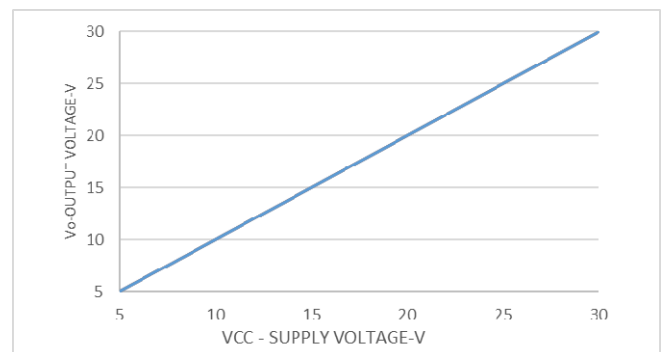

Fig.7 Propagation Delays vs. Temperature

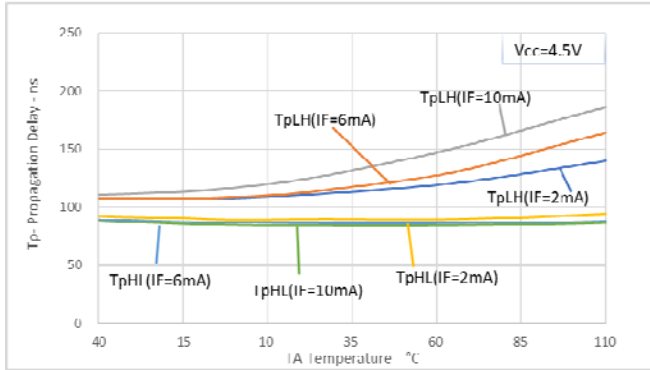

Fig.8 Propagation Delays vs. Temperature

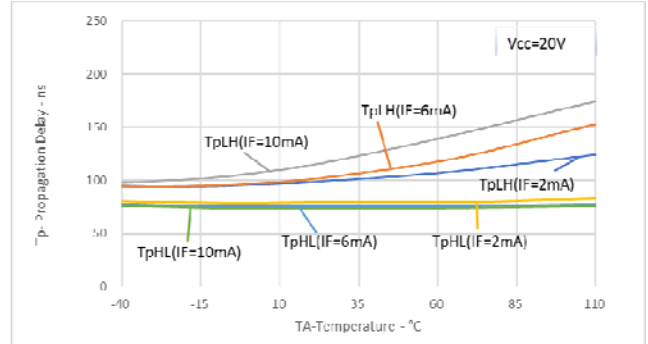
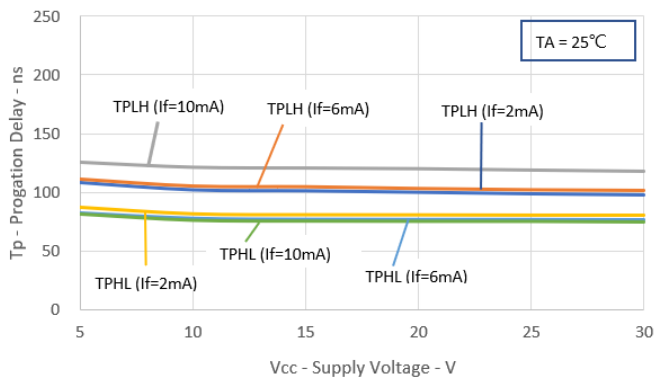

Fig.9 Propagation Delays vs. Vcc



● Recommended Soldering Conditions

IR Reflow soldering

One time soldering reflow is recommended within the condition of temperature and time profile shown below. Do not solder more than three times.

Recommended Temperature Profile of Infrared Reflow

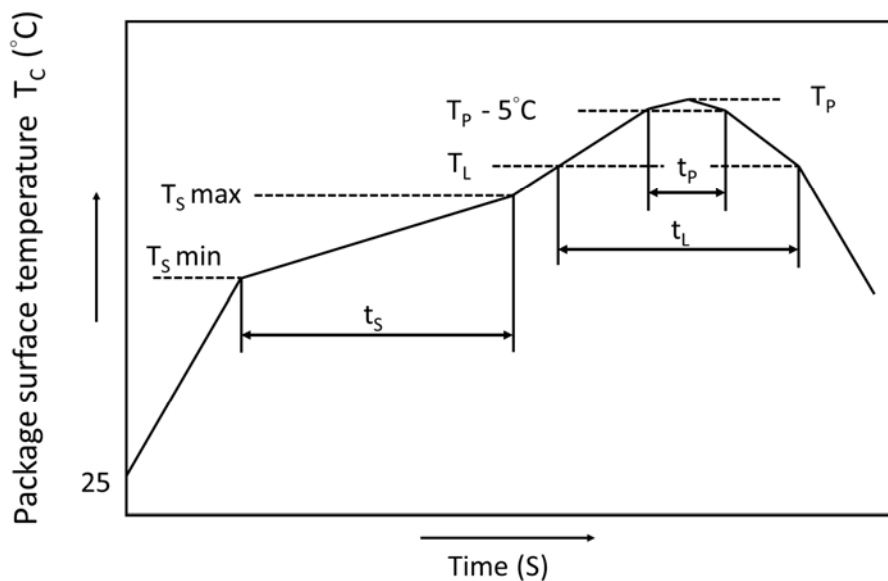

	Symbol	Min	Max	Unit
Preheat temperature	T_s	150	200	$^\circ\text{C}$
Preheat time	t_s	60	120	s
Ramp-up rate (T_L to T_P)			3	$^\circ\text{C/s}$
Liquidus temperature	T_L	217		$^\circ\text{C}$
Time above T_L	t_L	60	100	s
Peak Temperature	T_P		260	$^\circ\text{C}$
Time during which T_c is between ($T_P - 5$) and T_P	t_p		20	s
Ramp-down rate			6	$^\circ\text{C/s}$

- **Numbering System**

KT0481X (Y)-(Z)

Notes:

KT0481 = Part No.

X = Lead form option (P or W)

Y = Tape and reel option (TLD or TRU)

Z = VDE option (V or None)

Option	Description	Packing quantity
P (TLD)	surface mount type package + TL tape & reel option	3000 units per reel
P (TRU)	surface mount type package + TR tape & reel option	3000 units per reel
W (TLD)	long creepage distance for surface mount type package + TLD tape & reel option	3000 units per reel
W (TRU)	long creepage distance for surface mount type package + TRU tape & reel option	3000 units per reel

- **Recommended Pad Layout for Surface Mount Lead Form**

1. Surface mount type

6LSOP-P type

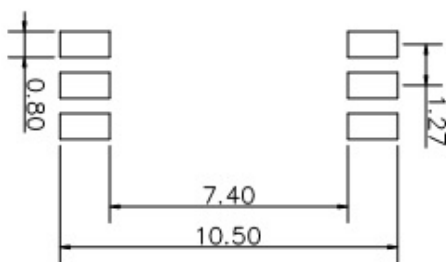
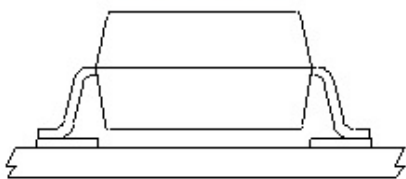

2. Long creepage distance for surface mount type

6LSOP-W type

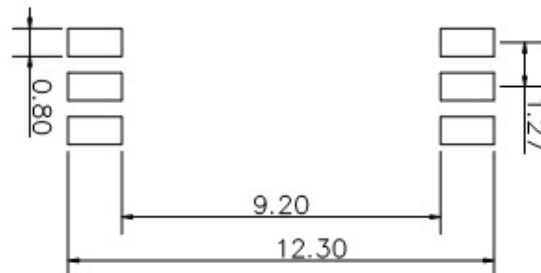
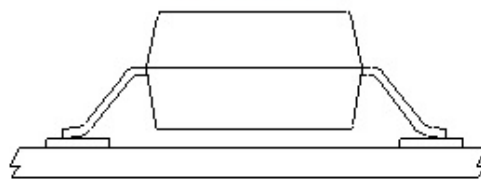

Unit :mm

● LSOP 6 Carrier Tape & Reel

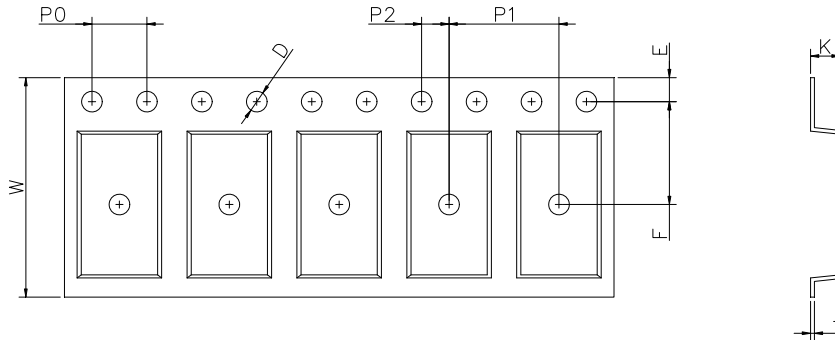

Dimension Symbol	D	E	F	P0	P1	P2	t	W	K
P type Dimension (mm)	1.5±0.1	1.75±0.1	7.5±0.1	4.0±0.1	8.0±0.1	2.0±0.1	0.3±0.1	16.0±0.3	2.15±0.1
W type Dimension (mm)	1.5±0.1	1.75±0.1	11.5±0.1	4.0±0.1	8.0±0.1	2.0±0.1	0.3±0.1	24.0±0.3	2.52±0.1

TRU

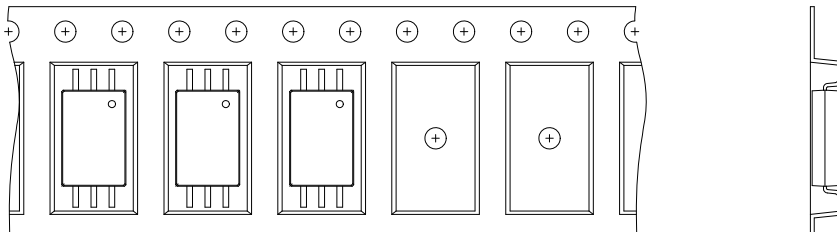

TLD

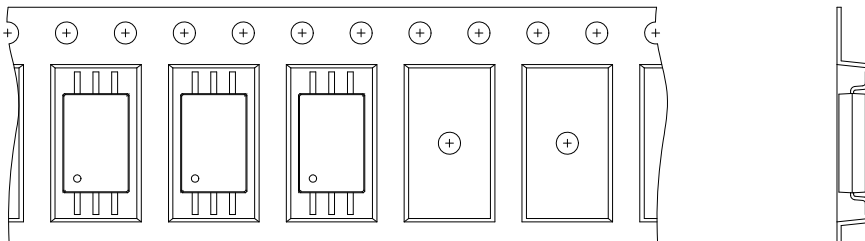

- **Application Notice**

The statements regarding the suitability of products for certain types of applications are based on cosmo's knowledge of general applications of cosmo products. Such statements are not binding statements about the suitability of products for a particular application. It is the customer's responsibility to verify the specifications are suitable for use in a particular application. Customers are solely responsible for all aspects of their own product design or applications. The parameters provided in the datasheet may vary in different applications and performance may vary over time. All operating parameters (including typical parameters) must be validated by customer's technical experts for different applications. cosmo assumes no liability for customer' product design or applications. Product specifications do not expand or otherwise change cosmo's terms and conditions of purchase, including but not limited to the warranty expressed therein.

When using cosmo products, please comply with safety standards and instructions. cosmo has no liability and responsibility to the damage caused by improper use of the instructions specified in the specifications.

cosmo products are designed for use in general electronic equipment such as telecommunications, office automation equipments, personal computers, test and measurement equipments, consumer electronics, industrial control, instrumentation, audio, video.

cosmo devices shall not be used in equipment that requires higher level of reliability and safety, such as nuclear power control equipment, telecommunication equipment(trunk lines), space application, medical and other life supporting equipments, and equipment for aircraft, military, automotive or any other application that can cause human injury or death.

cosmo reserves the right to change the specifications, data, characteristics, structure, materials and other contents at any time without notice. Please contact cosmo to obtain the latest specification.

cosmo disclaim any and all liability for any errors, inaccuracies or incompleteness contained in any datasheet or in any other disclosure relating to any product.