



佛山市国星光电股份有限公司  
FOSHAN NATIONSTAR OPTOELECTRONICS CO., LTD

# 产品规格书 SPECIFICATION

顾客名称 Customer		产品名称 Product	Chip LED
顾客型号 Customer Type		产品型号 Type	FC-A3010PDK
顾客部品号 Customer No.		版本号 Version NO	B 版



研发中心 Research & Development Center			客户 (加盖公章) Customer (Stamp)
制定 DRAW	审核 CHECK	批准 APPROVE	确认 CONFIRM
发放日期 (Release Date): 2016-11-25			

# FC-A3010PDK

## 技术数据表 Technical Data Sheet

本产品主要用作光信号接收器, 或智能系统状态开关元件, 如遥控接收器、智能光电开关等。

This product is mainly used as light signal receiver, or intelligent system switch, such as a remote control receiver and intelligent photoelectric switch.

- 特性:**
- 管芯材料: Silicon NPN  
Material:
  - 封装材料: 环氧树脂  
Encapsulation: Epoxy Resin
  - 焊接方法: 无铅回流焊  
Soldering methods: Pb-Free reflow soldering
  - 功耗低, 可靠性好, 寿命长  
Low Power Dissipation, Good Reliability and Long Lifespan
  - 符合欧盟公布的 ROHS 指令要求  
Complied With ROHS Directive
- Features:**

光敏三极管  
Phototransistor

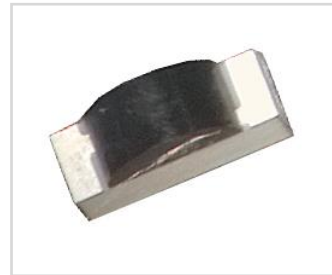



\* 产品规格如因工艺改进而有所改变, 恕不另行通知。  
\* The specifications of the product may be modified for improvement without notice.

## 外形尺寸

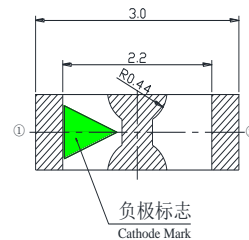
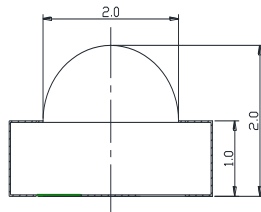
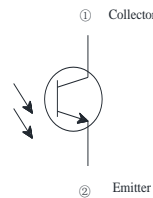
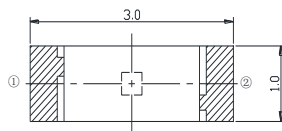
### Outline Dimension



敷铜区域:  
Cuprum Area:   
阻焊丝印区域:  
Solder Resist:   
\*无特别规定时, 公差: X.X±0.1, X.XX±0.05, 单位为mm\*  
\* The Tolerances Unless Mentioned is : X.X±0.1, X.XX±0.05, Unit= mm\*

## 光电参数 (1)

### Electro-Optical Characteristics(1)

极限参数 (温度=25℃)



Absolute Maximum Ratings (Temperature=25 °C)

参数名称 Parameter	符号 Symbol	数值 Rating	单位 Unit
集电极-发射极 (直流) 电压 Voltage of Collector-to-Emitter electrode (DC Current)	V <sub>ceo</sub>	30	V
发射极-集电极 (直流) 电压 Voltage of Emitter-to-Collector electrode (DC Current)	V <sub>eco</sub>	5	V
耗散功率 Power Dissipation	PM	75	mW
工作温度 Operating Temperature	T <sub>OPR</sub>	-30 ~ +85	°C
贮存温度 Storage Temperature	T <sub>stg</sub>	-40 ~ +100	°C

\* 注: 脉冲宽度≤0.1ms, 占空比≤1/10 \* Note: Pulse Width≤0.1ms, Duty≤1/10

光电参数 (温度=25℃)



### Electro-Optical Characteristics (Temperature=25 °C)

参数名称 Parameter	符号 Symbol	条件 Condition	最小值 Min.	典型值 Typ.	最大值 Max.	单位 Unit
光电流 Light Current	I <sub>L</sub>	V <sub>CE</sub> =5V Ee=0.5mW/cm <sup>2</sup>	0.1	0.4		mA
暗电流 Dark Current	I <sub>D</sub>	V <sub>CE</sub> =20V Ee=0mW/cm <sup>2</sup>			100	nA
集电极-发射极击穿电压 Collector-Emitter Breakdown Voltage	V <sub>(BR)CEO</sub>	I <sub>C</sub> =100mA Ee=0mW/cm <sup>2</sup>	30			V
发射极-集电极击穿电压 Emitter-Collector Breakdown Voltage	V <sub>(BR)ECO</sub>	I <sub>E</sub> =100μA Ee=0mW/cm <sup>2</sup>	5			V
峰值波长 Peak Wavelength	λ <sub>p</sub>	V <sub>CE</sub> =5V Ee=0.5mW/cm <sup>2</sup>		940		nm
脉冲上升时间 Impulse Rise time	t <sub>r</sub>	V <sub>ce</sub> =5V I <sub>C</sub> =1mA RL=1000 Ω		15		μs
脉冲下降时间 Impulse Fall time	t <sub>f</sub>			15		μs
响应波段 Sensitivity Wavelength Range	λ	-	730	-	1150	nm

\* 注: 以上参数仅供参考, 请以实物标签为准。我司给出的参数均由国星测试系统测得。

\* Note: The parameters above are only for your reference. In case of any discrepancy, please adhere to the label of our actual products. All parameters are tested by the standard testing system of NationStar.

# 典型特性曲线

## Typical Characteristics Curves

Collect Power Dissipation VS Ambient Temperature

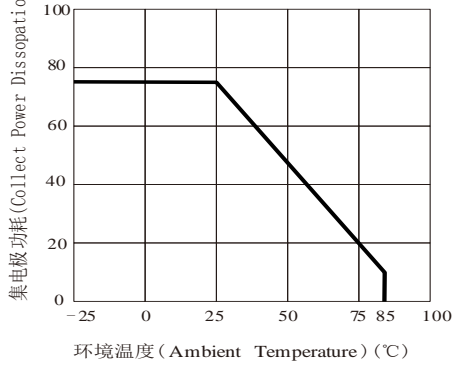

Collector Dark Current VS Ambient Temperature

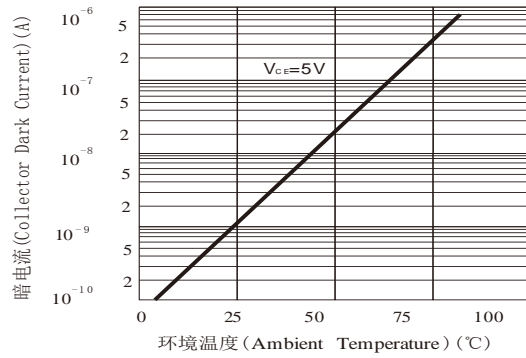

Relative Collector Current VS Ambient Temperature

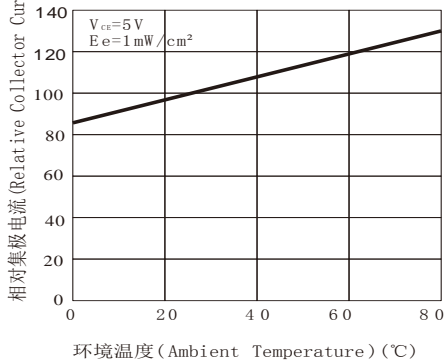

Collector Current VS Irradiance

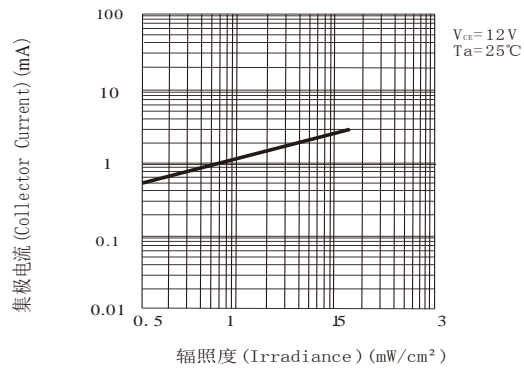

Spectral Sensitivity

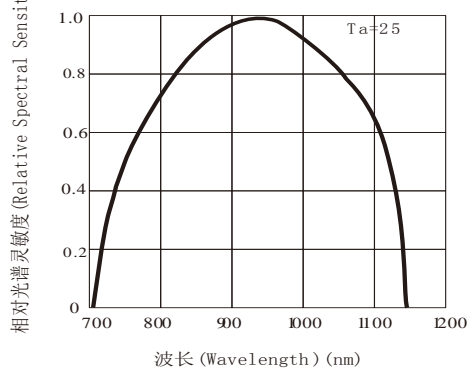

Collector Current VS Collector-Emitter Voltage

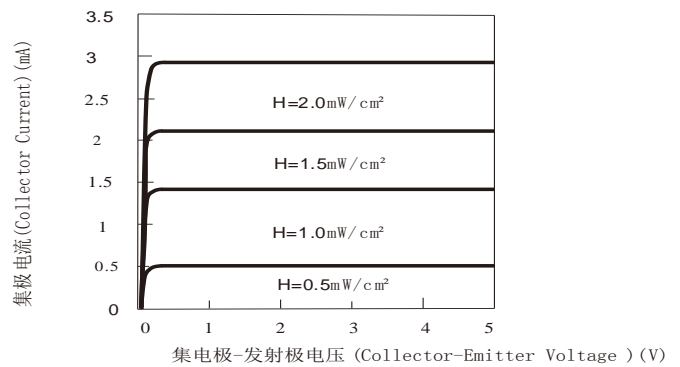

**可靠性试验**

**Reliability Test Items And Conditions**

实验项目 Test Items	参考标准 Reference	实验条件 Test Conditions	时间 Time	样品数 Quantity	判据 Criterion
冷热冲击 Thermal Shock	MIL-STD-202G	-40°C(15min)←→100°C(15min)	循环 200 次 200 cycles	22	无失效 No Damage
湿热循环 Temperature And Humidity Cyclic	JEITA ED-4701 200 203	(-10~65)°C , (0~90)%RH 24hrs./1cycle	循环 10 次 10 cycles	22	无失效 No Damage
高温储存 High Temperature Storage	JEITA ED-4701 200 201	Ta=100°C	1000h	22	无失效 No Damage
低温储存 Low Temperature Storage	JEITA ED-4701 200 202	Ta=-40°C	1000h	22	无失效 No Damage
常温寿命试验 Lifespan Test	---	Ta=25°C Vce=5V	1000h	22	IR ≦ 2 IR0 VF ≦ 1.2 VF0
耐焊接热 Resistance to Soldering Heat	GB/T 4937, II ,2.2&2.3	Tsol*=(260±5)°C 10secs.	2 次 2 times	22	无失效 No Damage

## 包装 (1)

### Packaging (1)

#### ◇ 载带 Carrier Tape

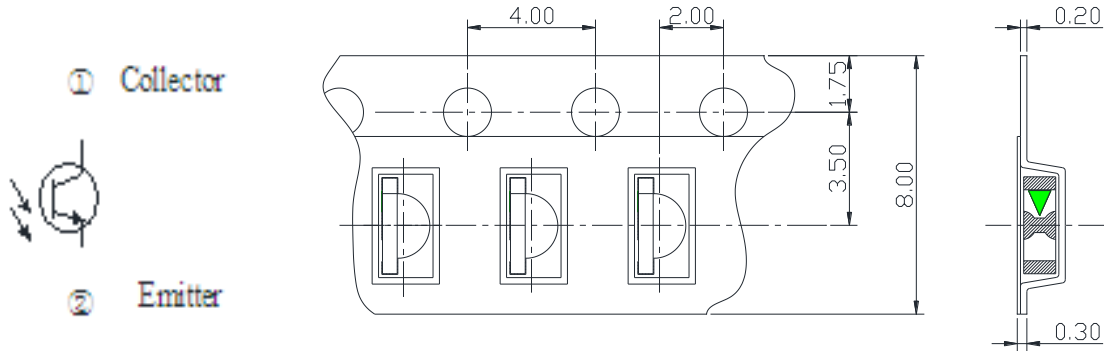

单位: mm, 未注公差:  $\pm 0.1$  mm

All dimensions in mm, tolerances unless mentioned is  $\pm 0.1$  mm.

#### ◇ 编带细节 Details Of Carrier Tape

前进方向 Progressive Direction  $\longrightarrow$

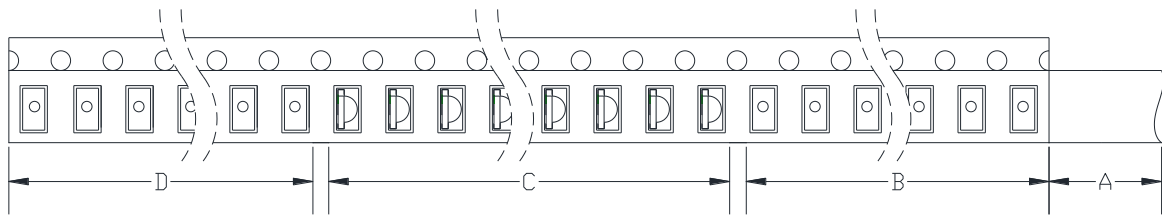

A: 盖带, 200 mm; B: 引导, 空带, 100mm; C: 编载产品 3000 只; D: 尾部, 空带, 100mm

A: Top Cover Tape, 200mm; B: Leader, Empty, 100mm; C: 3000 Lamps Loaded; D: Trailer, Empty, 100mm.

#### ◇ 带盘 Reel Dimension

前进方向 Progressive Direction  $\longrightarrow$

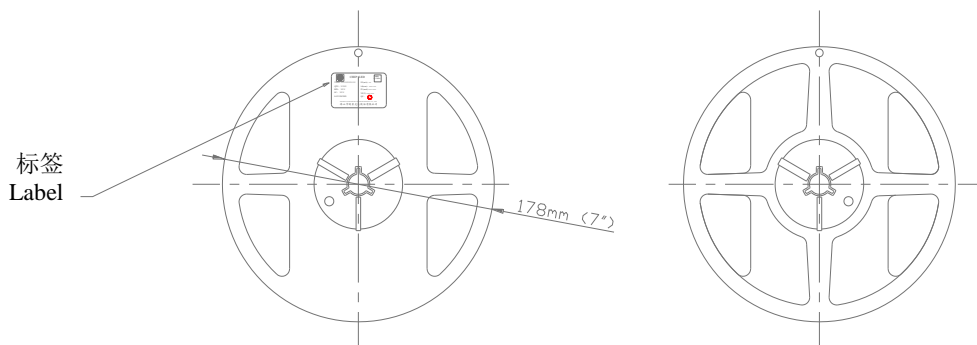

## 包装 (2)

### Packaging(2)

#### 防潮抗静电包装 Moisture Proof and Anti-Electrostatic Foil Bag

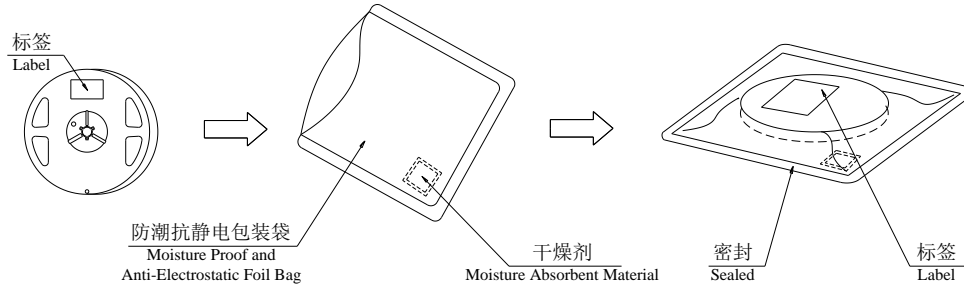

#### 外包装箱 Cardboard Box

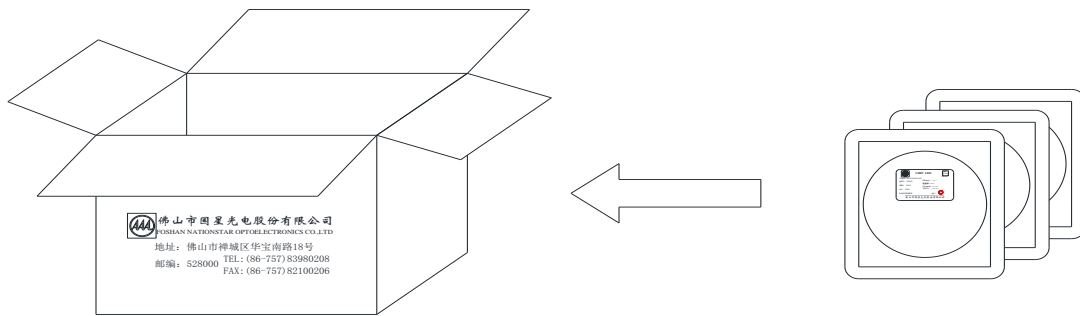

#### 标签说明 Label Explanation

TYPE: 产品型号

QTY: 数量 Quantity

BIN: 档次 Rank

SC: 分档表编号 Step Code

LOT: 批号 Lot Number

