



KT5W-2P2113

KT5

CONTRAST SENSORS

SICK
Sensor Intelligence.



Illustration may differ



Ordering information

Type	Part no.
KT5W-2P2113	1018043

Other models and accessories → www.sick.com/KT5

Detailed technical data

Features

Dimensions (W x H x D)	30.4 mm x 53 mm x 80 mm
Sensing distance	≤ 10 mm ¹⁾
Housing design	Rectangular
Light source	LED, RGB ²⁾
Wave length	470 nm, 525 nm, 640 nm
Light emission	Long and short side of housing, exchangeable
Light spot size	1.2 mm x 4.2 mm
Light spot direction	Horizontal ³⁾
Adjustment	Teach-in button
Teach-in mode	Teach-in dynamic

¹⁾ From leading edge of lens.

²⁾ Average service life: 100,000 h at T_J = +25 °C.

³⁾ In relation to long side of housing.

Mechanics/electronics

Supply voltage	10 V DC ... 30 V DC ¹⁾
Ripple	≤ 5 V _{pp} ²⁾
Current consumption	< 80 mA ³⁾
Switching frequency	10 kHz ⁴⁾
Response time	50 μs ⁵⁾

¹⁾ Limit values when operated in short-circuit protected network: max. 8 A.

²⁾ May not exceed or fall below U_v tolerances.

³⁾ Without load.

⁴⁾ With light/dark ratio 1:1.

⁵⁾ Signal transit time with resistive load.

⁶⁾ Short-circuit-proof.

⁷⁾ Reference voltage DC 50 V.

Switching output	PNP
Switching output (voltage)	PNP: HIGH = $U_V \leq 2 \text{ V}$ / LOW approx. 0 V
Output current I_{max}	100 mA ⁶⁾
Input, teach-in (ET)	PNP Teach: $U = 10 \text{ V} \dots < U_V$ Run: $U < 2 \text{ V}$
Input, light/dark (L/D)	PNP Light: $U = 0 \text{ V}$ Dark: $U > 10 \text{ V} \dots < U_V$
Retention time (ET)	25 ms, non-volatile memory
Connection type	Male connector M12, 5-pin
Protection class	II ⁷⁾
Circuit protection	U_V connections, reverse polarity protected Output Q short-circuit protected Interference pulse suppression
Enclosure rating	IP67
Weight	400 g
Housing material	Metal, zinc diecast

¹⁾ Limit values when operated in short-circuit protected network: max. 8 A.

²⁾ May not exceed or fall below U_V tolerances.

³⁾ Without load.

⁴⁾ With light/dark ratio 1:1.

⁵⁾ Signal transit time with resistive load.

⁶⁾ Short-circuit-proof.

⁷⁾ Reference voltage DC 50 V.

Ambient data

Ambient operating temperature	-10 °C ... +55 °C
Ambient temperature, storage	-25 °C ... +75 °C
Shock load	According to IEC 60068

Classifications

eCl@ss 5.0	27270906
eCl@ss 5.1.4	27270906
eCl@ss 6.0	27270906
eCl@ss 6.2	27270906
eCl@ss 7.0	27270906
eCl@ss 8.0	27270906
eCl@ss 8.1	27270906
eCl@ss 9.0	27270906
eCl@ss 10.0	27270906
eCl@ss 11.0	27270906
eCl@ss 12.0	27270906
ETIM 5.0	EC001820
ETIM 6.0	EC001820
ETIM 7.0	EC001820

ETIM 8.0	EC001820
UNSPSC 16.0901	39121528

Dimensional drawing (Dimensions in mm (inch))

KT5-2 Teach-in, KT5-2 Display

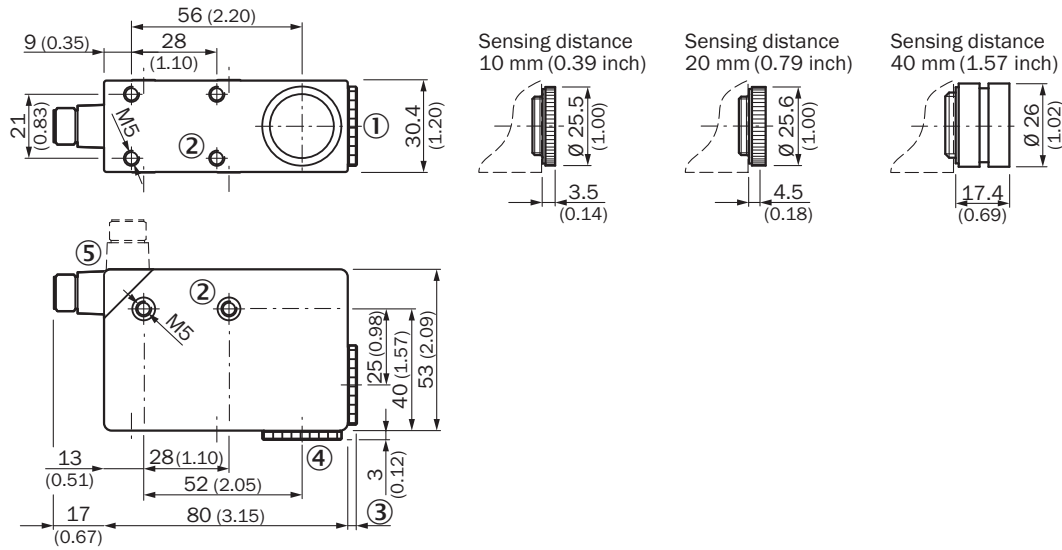

- ① Lens (light transmission), can be exchanged for pos. 4
- ② M5 threaded mounting hole, 5.5 mm deep
- ③ See dimensional drawings of lenses
- ④ Blind screw can be replaced by pos. 1
- ⑤ Connector M12 (rotatable up to 90°)

Adjustments

KT5-2 Teach-in, KT5W-xxx3

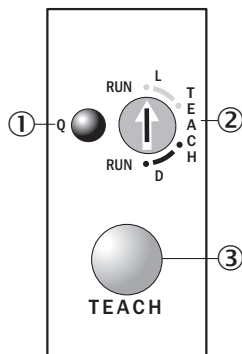

- ① Function signal indicator (yellow)
- ② Pre-selection switch
- ③ Teach-in button

Connection diagram

Cd-324

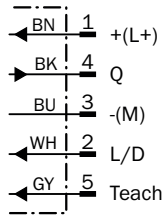

Concept of operation

KT5-2 Teach-in, teach-in dynamic

1. Select switching function (light/dark)

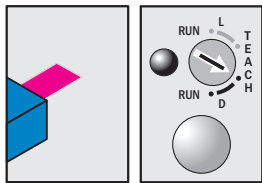

Turn rotary switch to desired teach position:
 D = dark switching
 L = light switching

2. Position mark or background

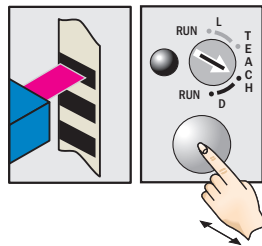

Press the teach-in button and keep it pressed.

3. Move at least one repeat length using the light spot

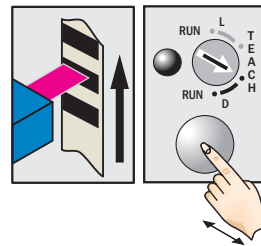

Keep the teach-in button pressed.

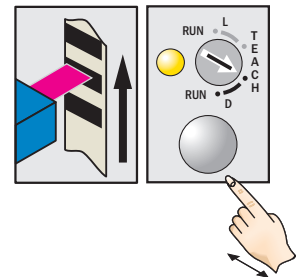

Release the teach-in button. Yellow LED will illuminate, when emitted light is on the mark.

Example

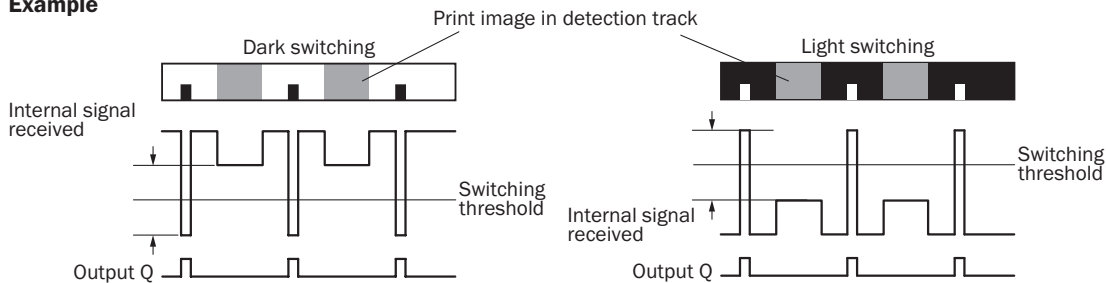

Switching characteristics

The optimum emitted light is selected automatically.

The switching threshold is set in the center between the lowest and the second-lowest reflectivity.

Teach-in can also be performed using an external control signal.

Light/dark setting can also be configured using an external control signal.

Observe the minimum speed (25 mm/s ... 300 mm/s).

Sensing distance









Sensing distance













- ① Sensing distance 10 mm
- ② Sensing distance 20 mm
- ③ Sensing distance 40 mm

Recommended accessories

Other models and accessories → www.sick.com/KT5

	Brief description	Type	Part no.
Lenses and accessories			
	Lens, 40 mm sensing distance, M20 x 0.75	OBJ-210	2010945
	Lens, 10 mm sensing distance, M20 x 0.75	OBJ-211	1004936
	Lens, 20 mm sensing distance, M20 x 0.75	OBJ-212	1011506
Universal bar clamp systems			
		BEF-KHS-G01	2022464
		BEF-KHS-K01	2022718
		BEF-KHS-KH1	2022726
		BEF-MS12G-A	4056054
		BEF-MS12G-B	4056055

	Brief description	Type	Part no.
		BEF-MS12L-A	4056052
		BEF-MS12L-B	4056053
Plug connectors and cables			
		YF2A15-020VB5XLEAX	2096239
		YF2A15-050VB5XLEAX	2096240
		YF2A15-100VB5XLEAX	2096241
		YG2A15-020VB5XLEAX	2096215
		YG2A15-050VB5XLEAX	2096216
		YG2A15-100VB5XLEAX	2096217
		DOS-1205-G	6009719
		DOS-1205-W	6009720

SICK AT A GLANCE

SICK is one of the leading manufacturers of intelligent sensors and sensor solutions for industrial applications. A unique range of products and services creates the perfect basis for controlling processes securely and efficiently, protecting individuals from accidents and preventing damage to the environment.

We have extensive experience in a wide range of industries and understand their processes and requirements. With intelligent sensors, we can deliver exactly what our customers need. In application centers in Europe, Asia and North America, system solutions are tested and optimized in accordance with customer specifications. All this makes us a reliable supplier and development partner.

Comprehensive services complete our offering: SICK LifeTime Services provide support throughout the machine life cycle and ensure safety and productivity.

For us, that is “Sensor Intelligence.”

WORLDWIDE PRESENCE:

Contacts and other locations –www.sick.com