



ATTENTION
OBSERVE PRECAUTIONS
FOR HANDLING
ELECTROSTATIC
DISCHARGE
SENSITIVE
DEVICES

Part Number: APB3025CGKQWDF-AMT

Green
White

Descriptions

- The Green source color devices are made with AlGaInP on GaAs substrate Light Emitting Diode.
- The source color devices are made with InGaN Light Emitting Diode.
- Electrostatic discharge and power surge could damage the LEDs.
- It is recommended to use a wrist band or anti-electrostatic glove when handling the LEDs.
- All devices, equipments and machineries must be electrically grounded.

Features

- High reliability LED package.
- 3.0mmx2.5mm SMD LED, 1.1mm thickness.
- Bi-color, low power consumption.
- Wide viewing angle.
- Ideal for backlight and indicator.
- Package : 2000pcs / reel.
- Moisture sensitivity level : level 3.
- RoHS compliant.

Applications

- Traffic signaling.
- Backlighting (illuminated advertising , general lighting).
- Interior and exterior automotive lighting.
- Substitution of micro incandescent lamps.
- Reading lamps.
- Signal and symbol luminaire for orientation.
- Marker lights (e.g. Steps, exit ways, etc).
- Decorative and entertainment lighting.
- Indoor and outdoor commercial and residential architectural lighting.

Package Dimensions

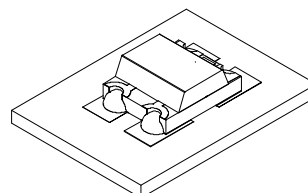
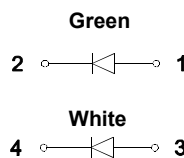
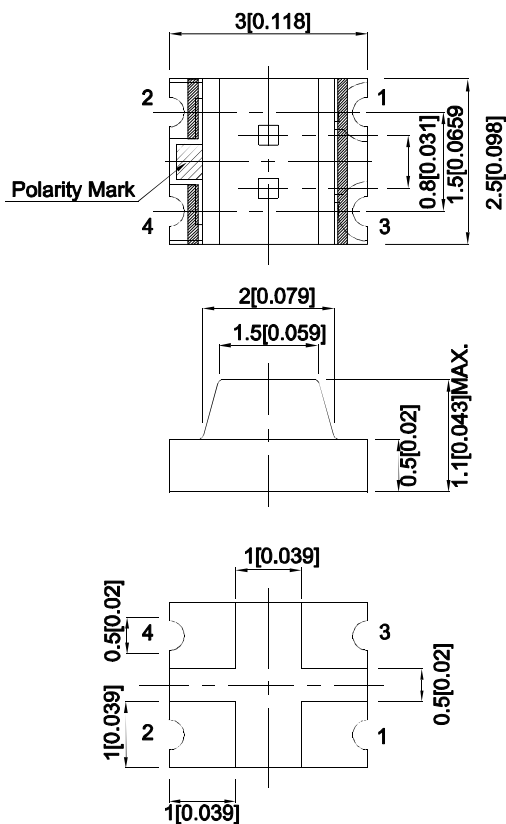

Notes:

1. All dimensions are in millimeters (inches).
2. Tolerance is $\pm 0.2(0.008)$ unless otherwise noted.
3. The specifications, characteristics and technical data described in the datasheet are subject to change without prior notice.
4. The device has a single mounting surface. The device must be mounted according to the specifications.



Selection Guide

Part No.	Emitting Color (Material)	Lens Type	Iv (mcd) [2] @ 20mA			Viewing Angle [1]
			Code.	Min.	Max.	2θ1/2
APB3025CGKQWDF-AMT	Green (AlGaInP)	Yellow Fluorescent	F	20	40	120°
			G	40	55	
			H	55	80	
	White (InGaN)		M	80	120	
	P		200	300		
	Q		300	400		
	R		400	500		

Notes:

1. θ1/2 is the angle from optical centerline where the luminous intensity is 1/2 of the optical peak value.
2. Luminous intensity/ luminous Flux: +/-15%.
3. Luminous intensity value is traceable to the CIE127-2007 compliant national standards.

Absolute Maximum Ratings at TA=25°C

Parameter	Symbol	Value		Unit	
		Green	White		
Power dissipation	PD	75	80	mW	
Operating Temperature	Top	-40 To+ 100		°C	
Storage Temperature	Tstg	-40 To+ 110		°C	
Junction temperature	TJ	115	115	°C	
DC Forward Current (TA=25°C)	IF	30	20	mA	
Peak Forward Current [1] (TA=25°C)	IFM	150	150	mA	
Reverse Voltage (TA=25°C)	VR	5	5	V	
Electrostatic Discharge Threshold (HBM)		3000	250	V	
Thermal resistance (Junction/ambient)	1 chip on (typ.) 2 chip on (typ.)	Rth j-a Rth j-a	720 870	530 670	°C/W

Note:

1. 1/10 Duty Cycle, 0.1ms Pulse Width.

Electrical / Optical Characteristics at TA=25°C (Green)

Parameter	Symbol	Value				Unit
		Code.	Min.	Typ.	Max.	
Wavelength at peak emission IF=20mA	λ peak			574		nm
Dominant Wavelength IF=20mA	λ dom [1]	4	565		567	nm
		5	567		569	
		6	569		571	
		7	571		573	
Spectral bandwidth at 50% Φ REL MAX IF=20mA	$\Delta\lambda$			20		nm
Forward Voltage IF=20mA	V _F [2]			2.1	2.5	V
Reverse Current (V _R = 5V)	I _R				10	uA
Temperature coefficient of λ peak IF=20mA, -10 ° C ≤ T ≤ 100 ° C	TC λ peak			0.12		nm/° C
Temperature coefficient of λ dom IF=20mA, -10 ° C ≤ T ≤ 100 ° C	TC λ dom			0.08		nm/° C
Temperature coefficient of V _F IF=20mA, -10 ° C ≤ T ≤ 100 ° C	TC _V			-1.8		mV/° C

Notes:

- 1.The dominant Wavelength (λ d) above is the setup value of the sorting machine. (Tolerance λ d : ±1nm.)
- 2.Forward Voltage: +/-0.1V.
- 3.Wavelength value is traceable to the CIE127-2007 compliant national standards.
- 4.Excess driving current and/or operating temperature higher than recommended conditions may result in severe light degradation or premature failure.

Electrical / Optical Characteristics at TA=25°C (White)

Parameter	Symbol	Value	Unit
Chromaticity coordinate x acc.to CIE1931 IF=20mA [Typ.]	x [1]	0.31	
Chromaticity coordinate y acc.to CIE1931 IF=20mA [Typ.]	y [1]	0.31	
Reverse Current (V _R = 5V) [Max.]	I _R	50	uA
Forward Voltage IF=20mA [Min.]	V _F [2]	-	V
Forward Voltage IF=20mA [Typ.]		3.3	
Forward Voltage IF=20mA [Max.]		4.0	
Temperature coefficient of V _F IF=20mA, -10 ° C ≤ T ≤ 100 ° C [Typ.]	TC _V	-2.0	mV/° C
Temperature coefficient of x IF=20mA, -10 ° C ≤ T ≤ 100 ° C [Typ.]	TC _x	-0.18	10 ⁻³ /° C
Temperature coefficient of y IF=20mA, -10 ° C ≤ T ≤ 100 ° C [Typ.]	TC _y	-0.20	10 ⁻³ /° C

Notes:

- 1.Measurement tolerance of the chromaticity coordinates is ±0.01.
- 2.Forward Voltage: +/-0.1V.
- 3.Excess driving current and/or operating temperature higher than recommended conditions may result in severe light degradation or premature failure.

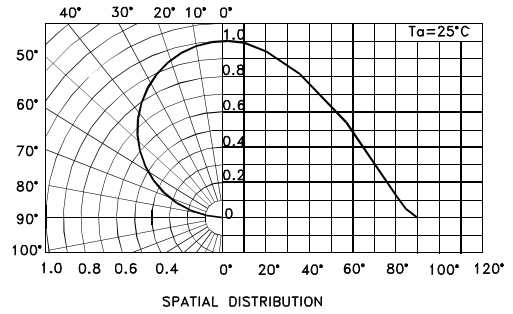
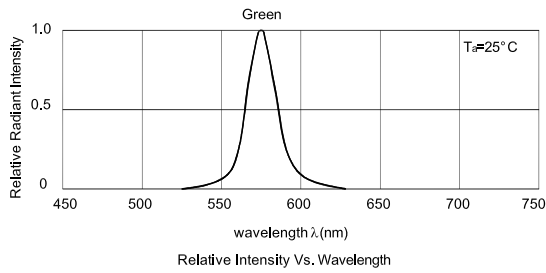

APB3025CGKQWDF-AMT Green

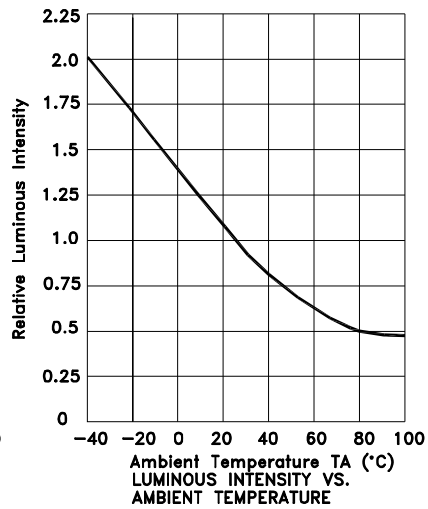
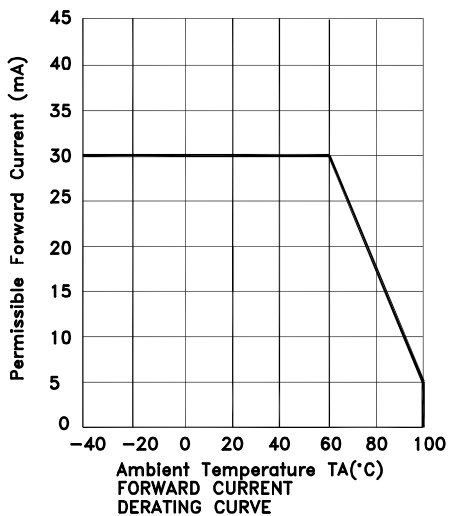
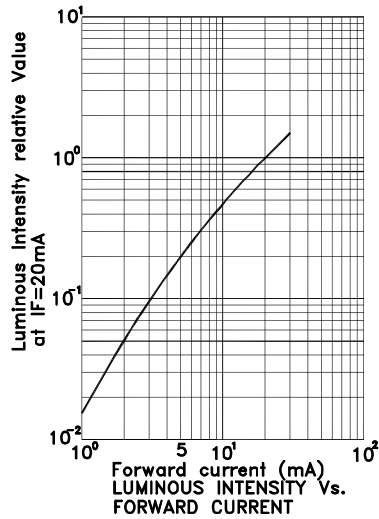
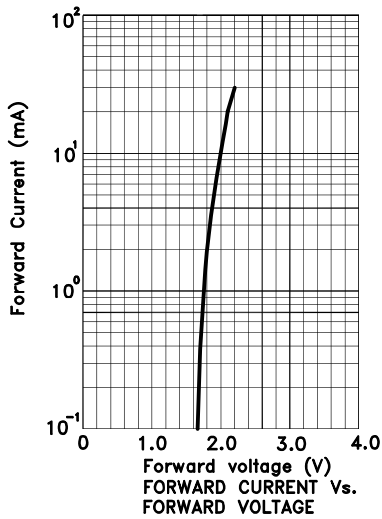

White

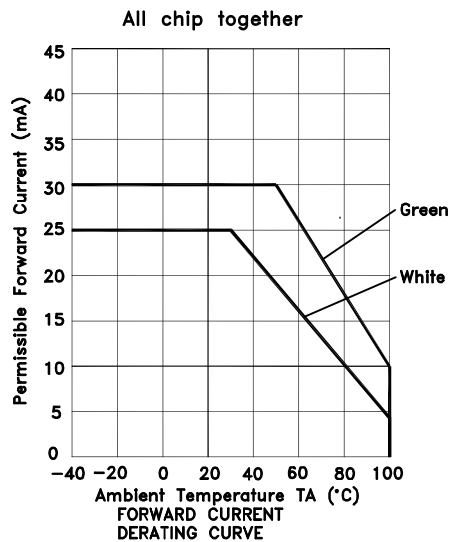
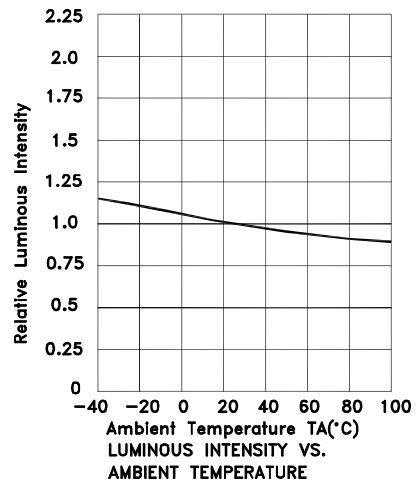
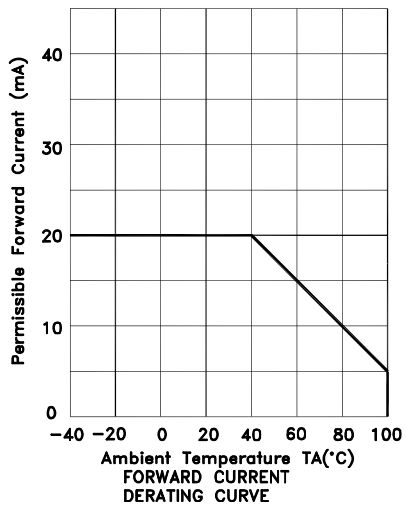
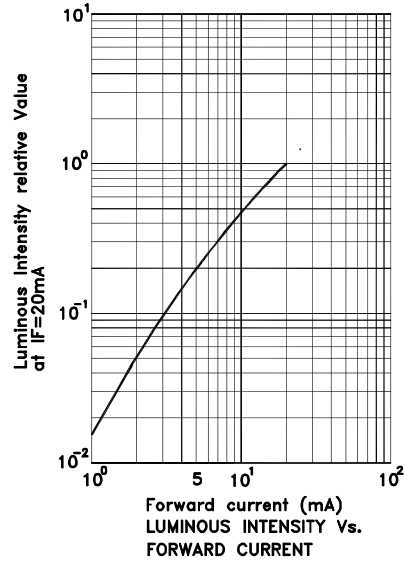
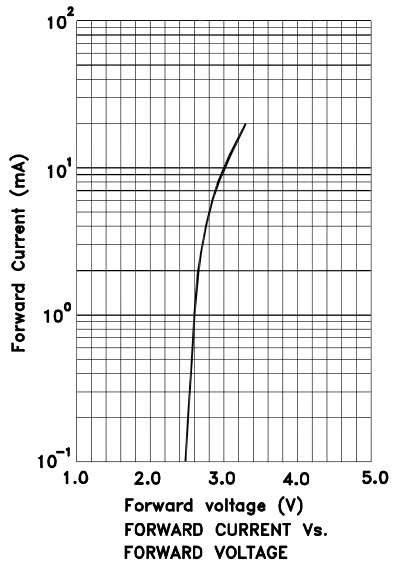

APB3025CGKQWDF-AMT

White CIE

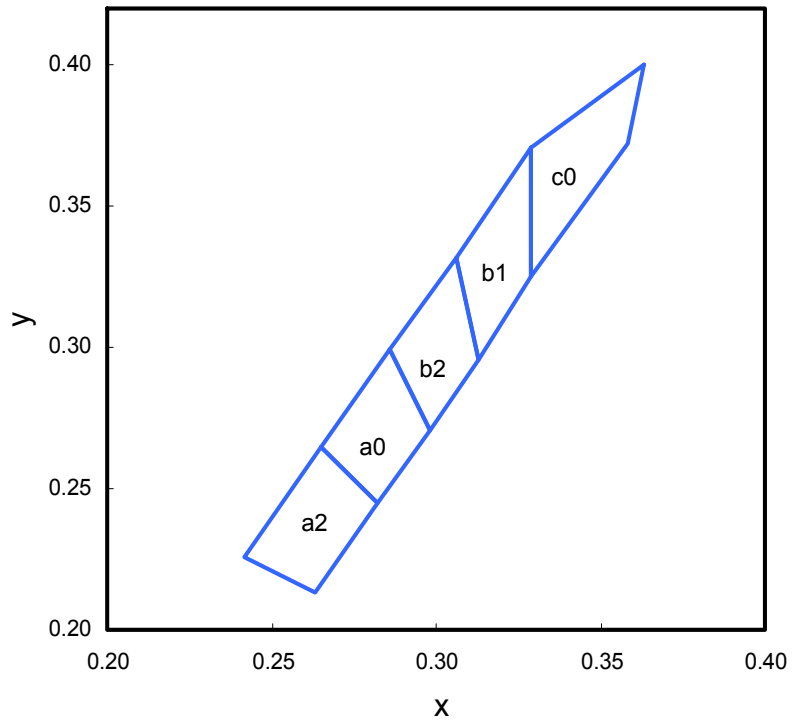

	x	y		x	y		x	y
a2	0.263	0.213	a0	0.282	0.245	b2	0.298	0.271
	0.282	0.245		0.298	0.271		0.313	0.296
	0.265	0.265		0.286	0.299		0.306	0.332
	0.242	0.226		0.265	0.265		0.286	0.299
b1	0.313	0.296	c0	0.329	0.325			
	0.329	0.325		0.358	0.372			
	0.329	0.371		0.363	0.400			
	0.306	0.332		0.329	0.371			

Notes:
 Shipment may contain more than one chromaticity regions.
 Orders for single chromaticity region are generally not accepted.
 Measurement tolerance of the chromaticity coordinates is ± 0.01 .

APB3025CGKQWDF-AMT

Reflow soldering is recommended and the soldering profile is shown below.
Other soldering methods are not recommended as they might cause damage to the product.

Reflow Soldering Profile For Lead-free SMT Process.

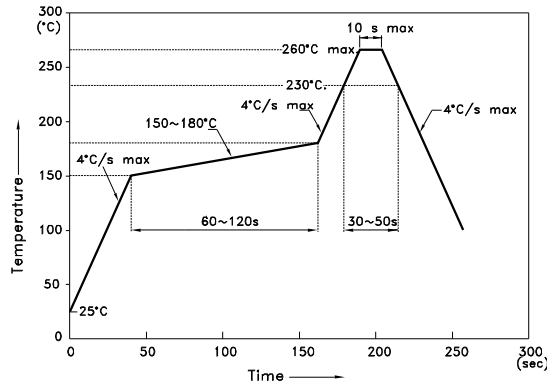

NOTES:

1. We recommend the reflow temperature 245°C(+/-5°C). The maximum soldering temperature should be limited to 260°C.
2. Don't cause stress to the epoxy resin while it is exposed to high temperature.
3. Number of reflow process shall be 2 times or less.

Recommended Soldering Pattern (Units : mm; Tolerance: ± 0.1)

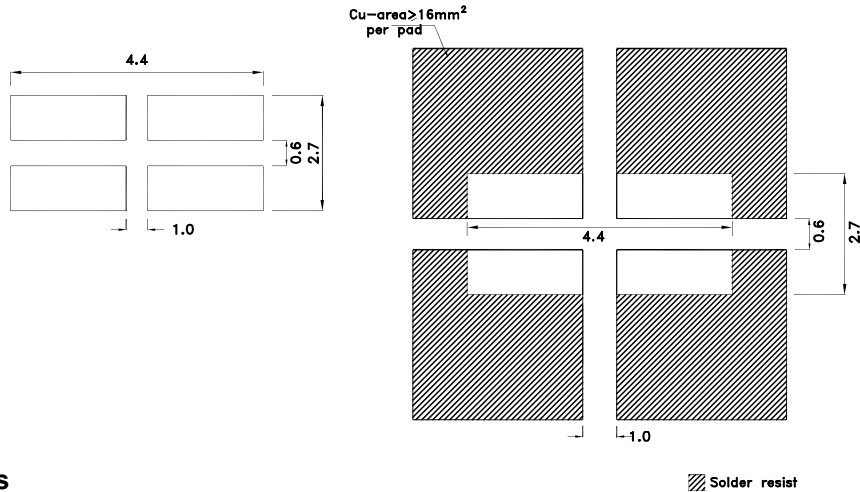

Tape Dimensions (Units : mm)

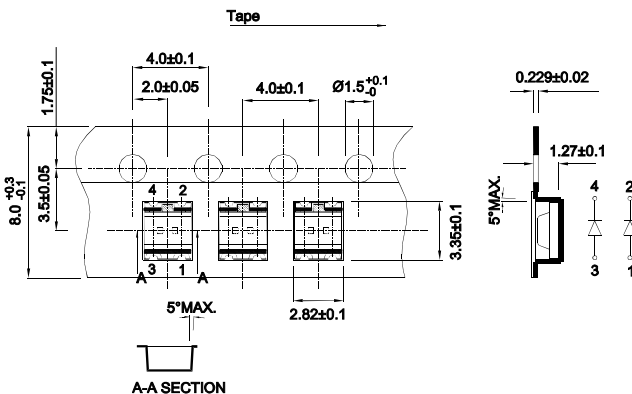

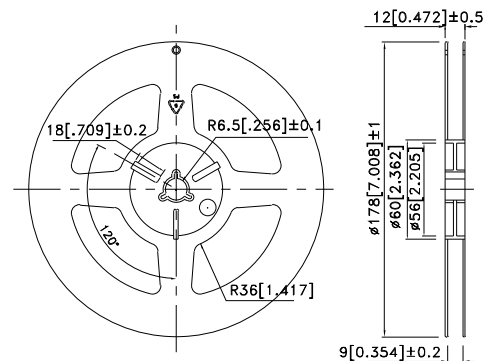

Reel Dimension

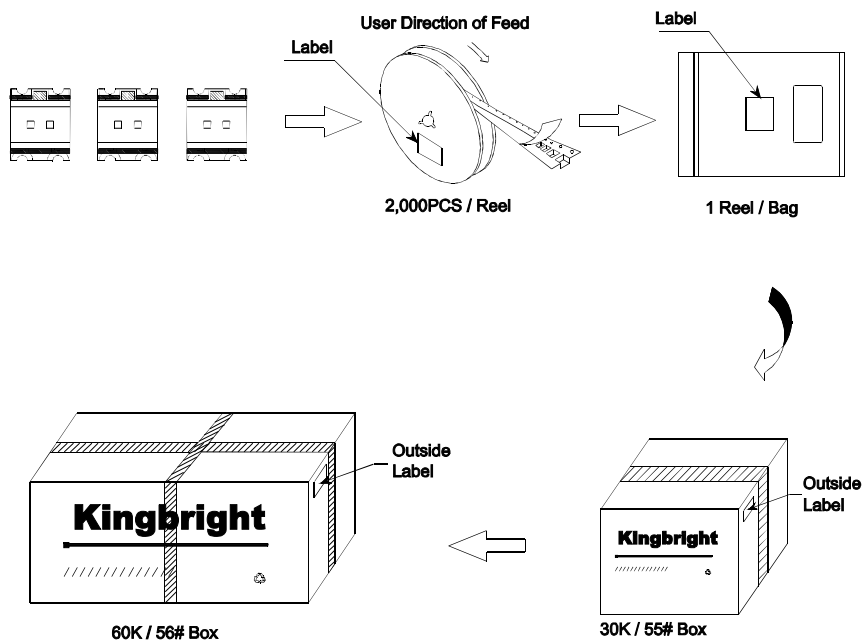

PACKING & LABEL SPECIFICATIONS

APB3025CGKQWDF-AMT



Kingbright		
P/NO: APB3025xxx		
QTY: 2,000 pcs	Q.C.	Q.C. xxxxxxx PASSED
S/N: XXXX		
CODE: XXX		
LOT NO:		
		
RoHS Compliant		

Terms and conditions for the usage of this document

1. The information included in this document reflects representative usage scenarios and is intended for technical reference only.
2. The part number, type, and specifications mentioned in this document are subject to future change and improvement without notice. Before production usage customer should refer to the latest datasheet for the updated specifications.
3. When using the products referenced in this document, please make sure the product is being operated within the environmental and electrical limits specified in the datasheet. If customer usage exceeds the specified limits, Kingbright will not be responsible for any subsequent issues.
4. The information in this document applies to typical usage in consumer electronics applications. If customer's application has special reliability requirements or have life-threatening liabilities, such as automotive or medical usage, please consult with Kingbright representative for further assistance.
5. The contents and information of this document may not be reproduced or re-transmitted without permission by Kingbright.
6. All design applications should refer to Kingbright application notes available at <http://www.KingbrightUSA.com/ApplicationNotes>

Reliability Test Items And Conditions

The reliability of products shall be satisfied with items listed below

Lot Tolerance Percent Defective (LTPD) : 10%

No.	Test Item	Standards	Test Condition	Test Times / Cycles	Number of Damaged
1	Continuous operating test	-	Ta =25°C ,IF = maximum rated current*	1,000 h	0 / 22
2	High Temp. operating test	EIAJ ED-4701/100(101)	Ta = 100°C IF =derated current at 100°C	1,000 h	0 / 22
3	Low Temp. operating test	-	Ta = -40°C, IF = maximum rated current*	1,000 h	0 / 22
4	High temp. storage test	EIAJ ED-4701/100(201)	Ta = maximum rated storage temperature	1,000 h	0 / 22
5	Low temp. storage test	EIAJ ED-4701/100(202)	Ta = -40°C	1,000 h	0 / 22
6	High temp. & humidity storage test	EIAJ ED-4701/100(103)	Ta = 60°C, RH = 90%	1,000 h	0 / 22
7	High temp. & humidity operating test	EIAJ ED-4701/100(102)	Ta = 60°C, RH = 90% IF = derated current at 60°C	1,000 h	0 / 22
8	Resistance to Soldering Heat	EIAJ ED-4701/100(301)	TSId=260±5°C, 10 sec	2 times	0 / 18
9	Thermal shock operating test	-	Ta = -40°C(15min) ~ 100°C(15min) IF = derated current at 100°C	1,000 cycles	0 / 22
10	Thermal shock test	-	Ta = -40°C(15min) ~ 100°C(15min)	1,000 cycles	0 / 22
11	Electric Static Discharge (ESD)	EIAJ ED-4701/100(304)	C = 100pF , R2 = 1.5KΩ V=3000V(Green) V = 250V(White)	Once each Polarity	0 / 22
12	Vibration test	-	a = 196m/s ² , f = 100~2KHz , t = 48min for all xyz axes	4 times	0 / 22

* : Refer to forward current vs. derating curve diagram

Failure Criteria

Items	Symbols	Conditions	Failure Criteria
luminous Intensity	Iv	IF = 20mA	Testing Min. Value <Spec.Min.Value x 0.5
Forward Voltage	VF	IF = 20mA	Testing Max. Value ≥Spec.Max.Value x 1.2
Reverse Current	IR	VR = Maximum Rated Reverse Voltage	Testing Max. Value ≥Spec.Max.Value x 2.5
High temp. storage test	-	-	Occurrence of notable decoloration, deformation and cracking