

# PM-1064-10

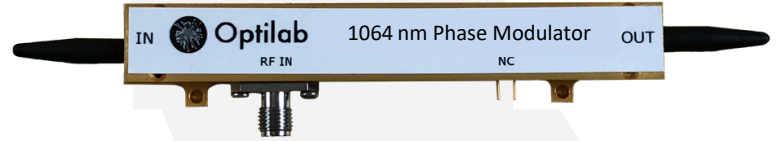

## DEVICE

# 10 GHz, 1064 nm Phase Modulator

## OVERVIEW

The Optilab PM-1064-10 is a high performance, 10 GHz LiNbO<sub>3</sub> phase modulator. PM-1064-10 can provide phase modulation in a broad operation bandwidth with a low driving voltage. Its low insertion loss provides for maximum transmission power. The PM-1064-10 is fabricated with Annealed Proton Exchange (APE) optical waveguides, and uses polarization maintaining input and output fibers, making it easy to integrate with other optical components. Contact Optilab for more information.

## FEATURES

- 1030 nm to 1070 nm
- X-cut APE Process
- 10 GHz Bandwidth
- Low Optical Loss
- Minimal Back Reflections
- Polarization Maintaining

## USE IN

- Coherent Communications
- Optical Chirping
- Optical Sensing
- FM Spectroscopy
- Frequency Shifting
- Laser Linewidth Broadening

## FUNCTION DIAGRAM

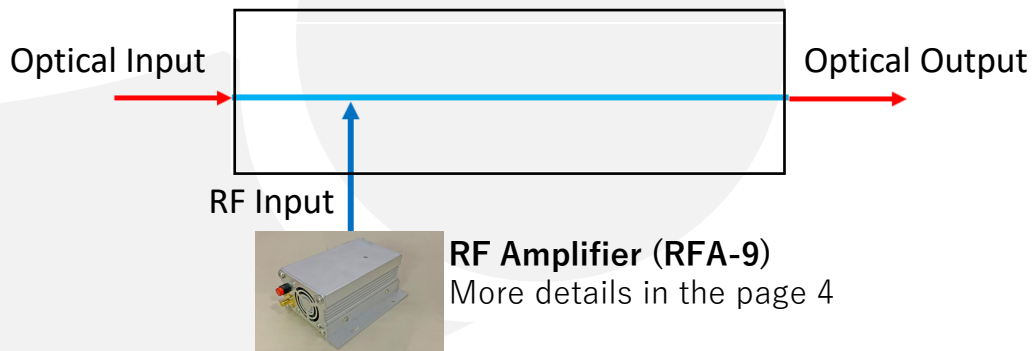

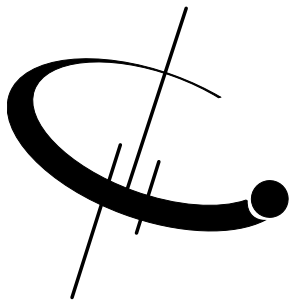

# PM-1064-10



## SPECIFICATIONS

### GENERAL

Input Optical Power	60 mW max
Operating Wavelength	1030 nm to 1070 nm
Insertion Loss	3.0 dB typical, 3.5 dB max
Chip Polarization Extinction Ratio	> 60 dB
Pigtail Polarization Extinction Ratio	≥ 20 dB
Process	Proton Exchange
Optical Return Loss	≥ 30 dB
S <sub>21</sub> Bandwidth	7 GHz min, 10 GHz typical @ -3 dB
S <sub>11</sub> Return Loss	≤ -10 dB @ 10 GHz
V <sub>π</sub>	6.8 V typical @ 1 GHz 10 V typical @ 10 GHz
RF Input Power	+27 dBm max
Impedance	50 Ω typical

### MECHANICAL

Operating Temperature	-55°C to +75°C
Storage Temperature	-60 °C to +90 °C
Operating Humidity	0% to 90% Relative Humidity
Input Fiber	Panda, PM 980
Output Fiber Type	Panda, PM 980
Input Connector	PM FC/APC, others available
Output Connector	PM FC/APC; others available
RF Port Connectors	K Connector
Cabling	900 μm tubing
Dimension	3.783" x 0.981" x 0.640"



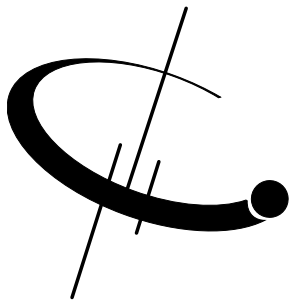

# PM-1064-10



TYPICAL S21 RESPONSE

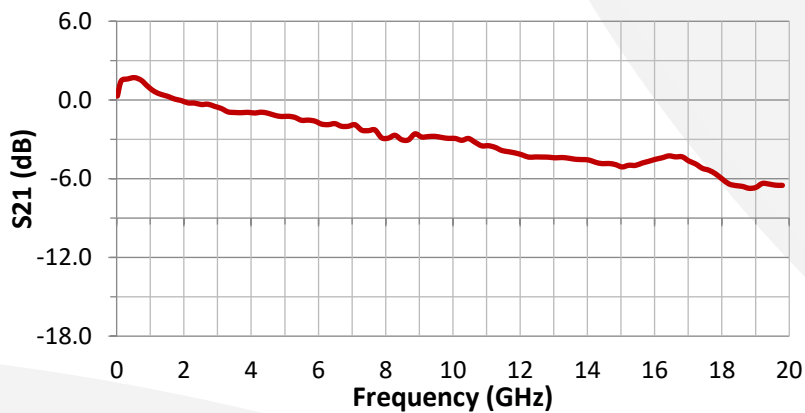

TYPICAL S11 RESPONSE

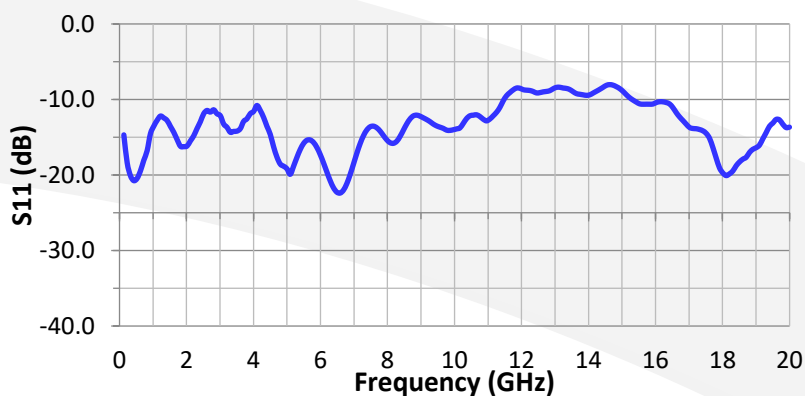

MECHANICAL DRAWING

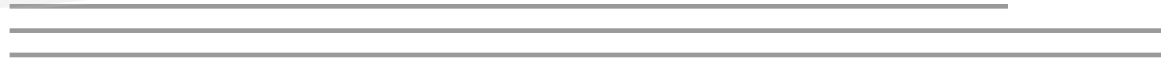
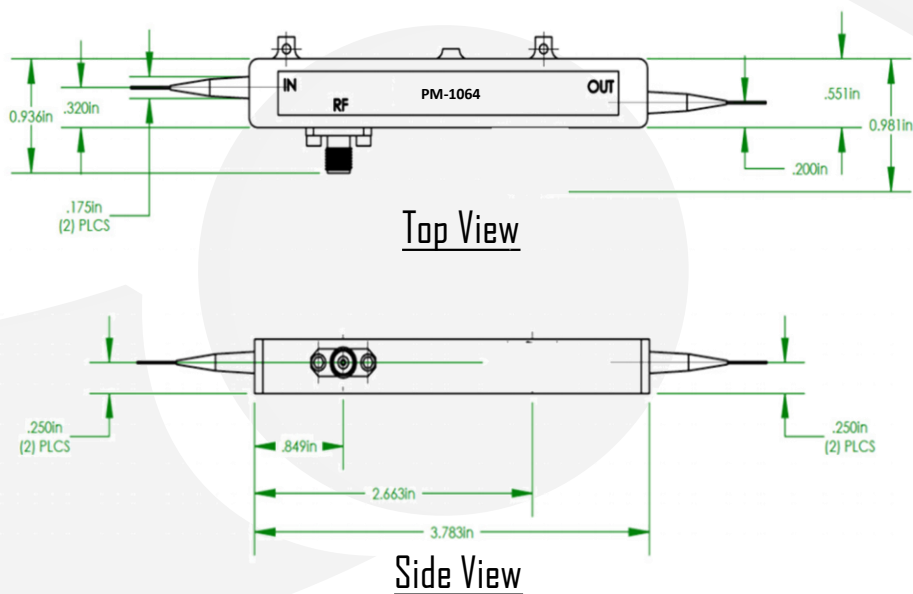

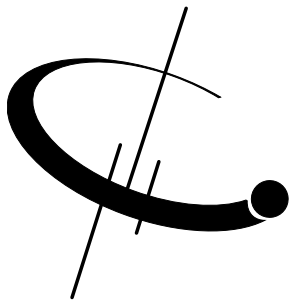

# PM-1064-10



Available  
Accessories

- **RFA-9**



The Optilab RFA-9 is a high gain RF amplifier module with 30dBm output and 10V peak to peak. It offers cost-effective solutions for microwave and analog link. Please contact Optilab for more detail.

