

GERI-RZ

~15° spot beam with holder

TECHNICAL SPECIFICATIONS:

Dimensions	45.0 mm
Height	32.8 mm
Fastening	glue, pin, screw
Colour	white
Box size	
Box weight	0 kg
Quantity in Box	224 pcs
ROHS compliant	yes ⓘ



MATERIAL SPECIFICATIONS:

Component	Type	Material	Colour
GERI-RZ	Single lens	PMMA	clear
GERI-HLD-A	Holder	PC	white
GERI-HLD-PLATE	Tape	PC	white

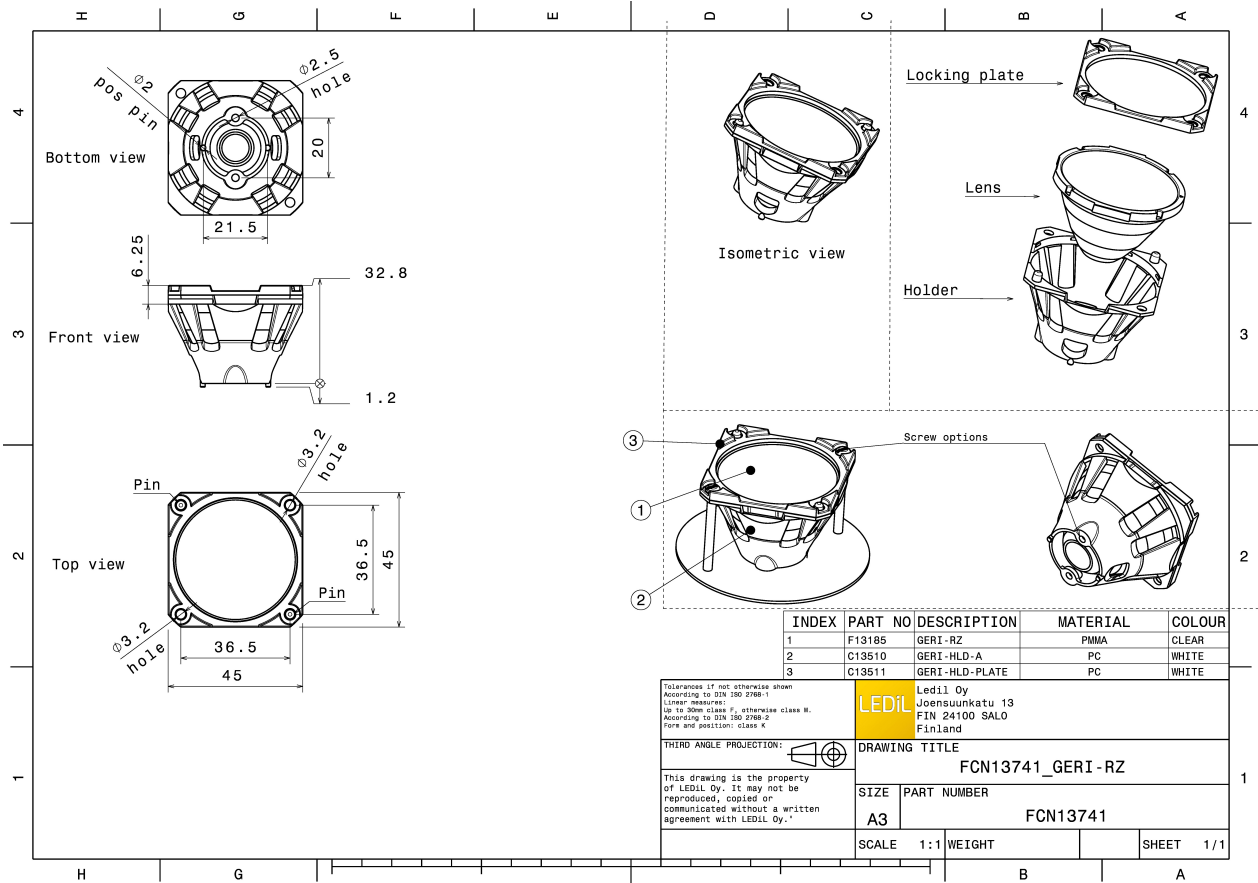

PHOTOMETRIC DATA (MEASURED):

CREE 

LED MC-E RGB
 FWHM 15.0°
 Efficiency 90 %
 Peak intensity 7.800 cd/lm
 LEDs/each optic 1
 Light colour White
 Required components:

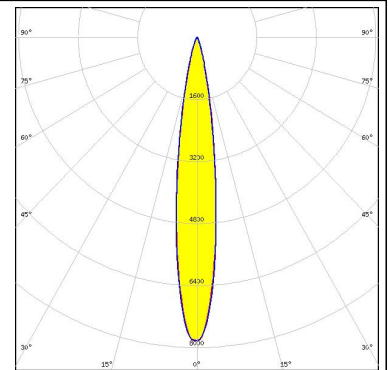

CREE 

LED XM-L RGB
 FWHM 16.0°
 Efficiency 90 %
 Peak intensity 7.500 cd/lm
 LEDs/each optic 1
 Light colour White
 Required components:

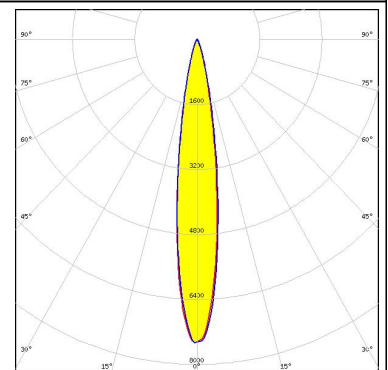
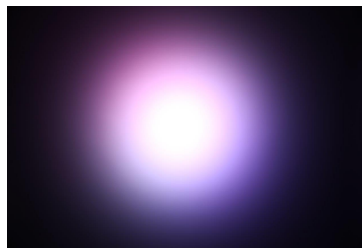

CREE 

LED XP-G3
 FWHM 15.0°
 Efficiency 85 %
 Peak intensity 7.200 cd/lm
 LEDs/each optic 1
 Light colour White
 Required components:

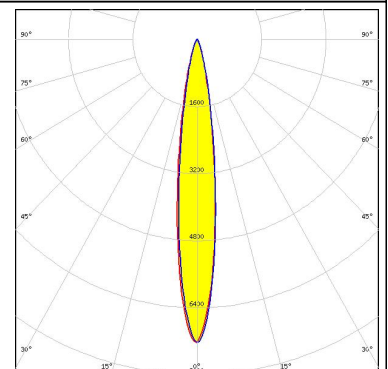
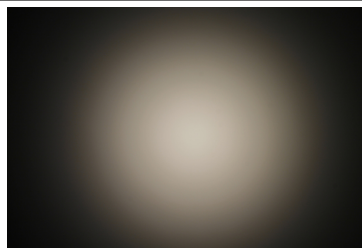

CREE 

LED XQ-E HD
 FWHM 17.0°
 Efficiency 86 %
 Peak intensity 5.200 cd/lm
 LEDs/each optic 4
 Light colour RGBW
 Required components:

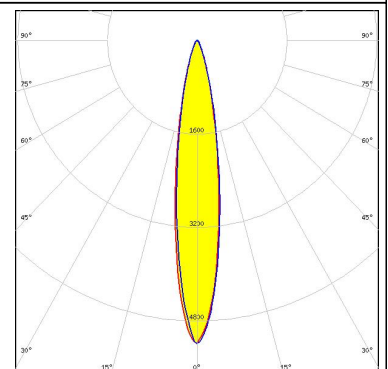
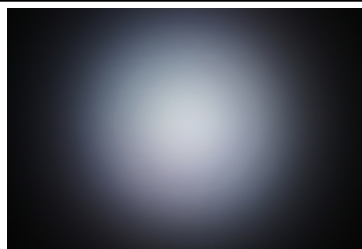

PHOTOMETRIC DATA (MEASURED):



LED XQ-E HI
 FWHM 17.0°
 Efficiency 85 %
 Peak intensity 6.510 cd/m
 LEDs/each optic 4
 Light colour RGBW
 Required components:

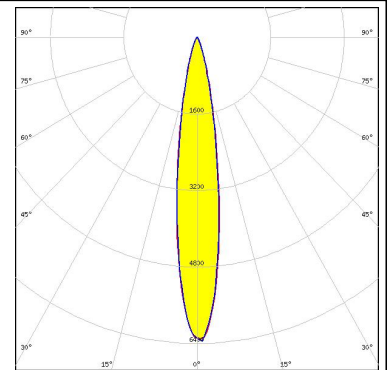
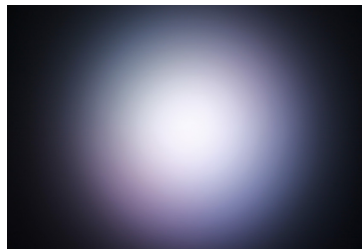

LED XT-E
 FWHM 15.0°
 Efficiency 84 %
 Peak intensity 6.600 cd/m
 LEDs/each optic 1
 Light colour White
 Required components:

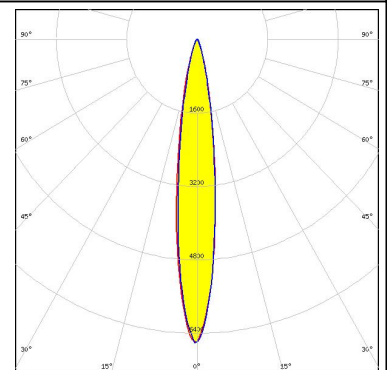
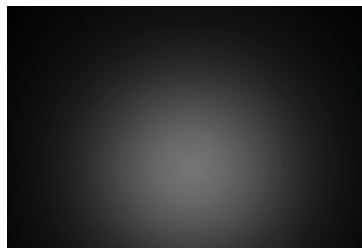

LED LUXEON C
 FWHM 20.0°
 Efficiency 89 %
 Peak intensity 5.060 cd/m
 LEDs/each optic 4
 Light colour RGBW
 Required components:

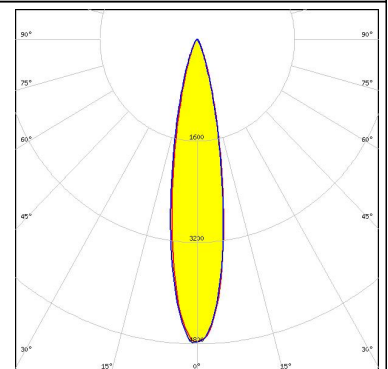
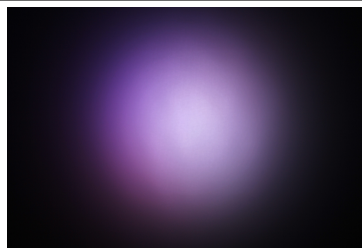

LED LUXEON Z
 FWHM 15.0°
 Efficiency 89 %
 Peak intensity 7.600 cd/m
 LEDs/each optic 4
 Light colour RGBW
 Required components:

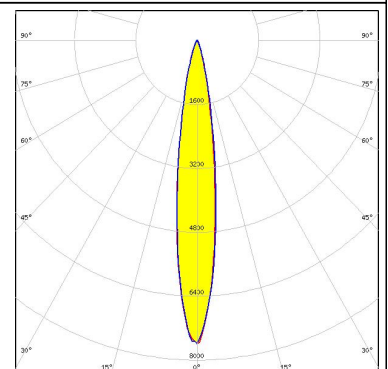
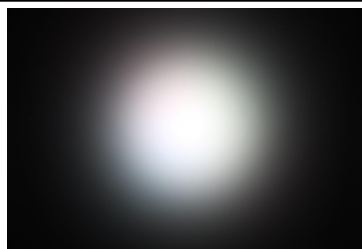

PHOTOMETRIC DATA (MEASURED):

OSRAM
Opto Semiconductors

LED OSTAR Stage (S2WP)
FWHM 15.0°
Efficiency 87 %
Peak intensity 8.660 cd/lm
LEDs/each optic 1
Light colour White
Required components:



OSRAM
Opto Semiconductors

LED Ostar-SMT RGB
FWHM 13.0°
Efficiency 89 %
Peak intensity 9.800 cd/lm
LEDs/each optic 1
Light colour White
Required components:

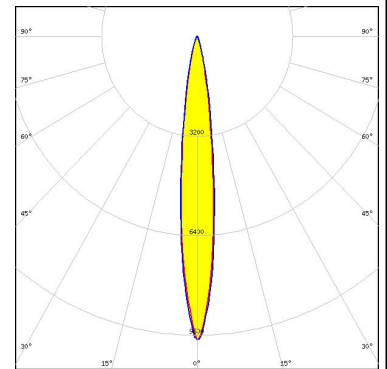
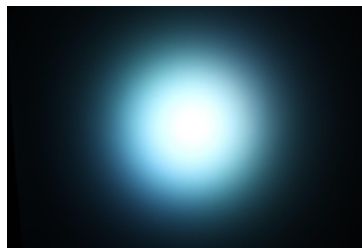

SEOL
SEOUL SEMICONDUCTOR

LED F50360 (RGB)
FWHM 14.0°
Efficiency 90 %
Peak intensity 9.000 cd/lm
LEDs/each optic 1
Light colour White
Required components:

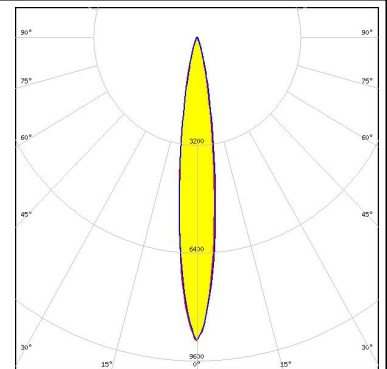
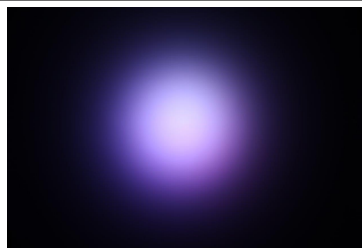

GENERAL INFORMATION:

NOTE: The typical beam angle will be changed by different color, chip size and chip position tolerance. The typical total beam angle is the full angle measured where the luminous intensity is half of the peak value.

MATERIALS:

As part of our continuous research and improvement processes, and to ensure the best possible quality and availability of our products, LEDiL reserves the right to change material grades without notice.

PRODUCT DATA USER AGREEMENT AND DISCLAIMER:

The measured data in the provided downloadable LEDiL Product Datasheets and Mechanical 2D-Drawings is rounded and provided as reference for planning. LEDiL Oy's optical specifications have been verified by conducting performance testing of the products in accordance with the company's quality system. The reported data are averaged results of multiple measurements with typical variation. LEDiL Oy reserves the right to without prior notification make changes and improvements to its products.

LEDiL Oy assumes neither warranty, nor guarantee nor any other liability of any kind for the contents and correctness of the provided data. The provided data has been generated with highest diligence but the provided data may in reality not represent the complete possible variation range of all intrinsic parameters. Therefore, in certain cases a deviation from the provided data could occur.

LEDiL Oy reserves the right to undertake technical changes of its products without further notification which could lead to changes in the provided data. LEDiL Oy assumes no liability of any kind for the possible deviation from any provided data or any other damage resulting from the usage of the provided data.

The user agrees to this disclaimer and user agreement with the download or usage of the provided files.

LEDiL Oy

Joensuunkatu 13
FI-24240 SALO
Finland

LEDiL Inc.

228 West Page Street
Suite D
Sycamore IL 60178
USA

Local sales and technical support

[www.ledil.com/
where_to_buy](http://www.ledil.com/where_to_buy)

Shipping locations

Salo, Finland
Hong Kong, China

Distribution Partners

[www.ledil.com/
where_to_buy](http://www.ledil.com/where_to_buy)