

# APPROVAL SHEET

## (RoHS)

CUSTOMER : \_\_\_\_\_  
CUSTOMER'S PART NO : \_\_\_\_\_  
DESCRIPTION : \_\_\_\_\_  
PART NO. : MND-06CZER33M-XB-RU  
DATE : 2021/08/03  
AUTHORIZED BY : *SQT*

	FULLY APPROVED	PARTIALLY APPROVED	REJECTED
SIGN			
SUGGESTION			

**MAG. LAYERS USA**  
**US OFFICE**  
5406 Bolsa Avenue, Huntington Beach, CA 92649, USA  
TEL: (714) 898-8377 FAX: (714) 898-8399  
<http://www.maglayersusa.com>  
E-mail : [info@maglayersusa.com](mailto:info@maglayersusa.com)



**MAG.LAYERS**



## ■ Application

DC to DC converter

## ■ Features

RoHS compliant & halogen free

Low resistance and high current rating

Magnetic core made by high performance magnetic metal powder

## ■ Product Identification

①      ②      ③ ④      ⑤      ⑥  
MND - 06CZ E R33 M - XB - R U

① Product Code

② Dimensions

③ Inductance: R33 = 0.33  $\mu$ H

④ Inductance Tolerance: M =  $\pm$ 20%

⑤ Series Type: XB Type

⑥ Pattern code-RT, RU Blank

Note: Please refer to the "Product Dimension" for detail dimensions.



■ **Electrical Performance**

Part number	Inductance ±20%@0A  (μH)	Rdc(mΩ)		Heat rating current (Idc) <sup>1</sup>  DC amps (A)	Saturation current (Isat) <sup>2</sup>  DC amps (A)
		Typ.	Max.		
MND-06CZER33M-XB-RU	0.33	2.3	2.53	25.0	30.0

**Test frequency:** 100KHz, 0.25V.

**Test instruments:** Inductance/saturation current: Keysight 4285A or equivalent.

Rdc: ADEX AX1152D or equivalent.

**Notes:**

1. The heat rating current (Idc) will cause temperature rise approximate 40°C.
2. The saturation current (Isat) will cause initial inductance drop approximate 30%.
3. All test data is referenced at 25°C ambient.
4. Operating temperature range -55°C to +125°C.
5. The part temperature (ambient + temp rise) should not exceed 125°C under the worst condition.
6. The temperature of component is affected by application conditions, e.g. circuit design, copper thickness of PCB and cooling conditions, the actual component temperature should be tested in the end application.
7. Withstand voltage: 25V DC. (Based on Maglayers test method, it may not the same under different application, it is recommended to verify first.)



■ **Electrical Characteristics**

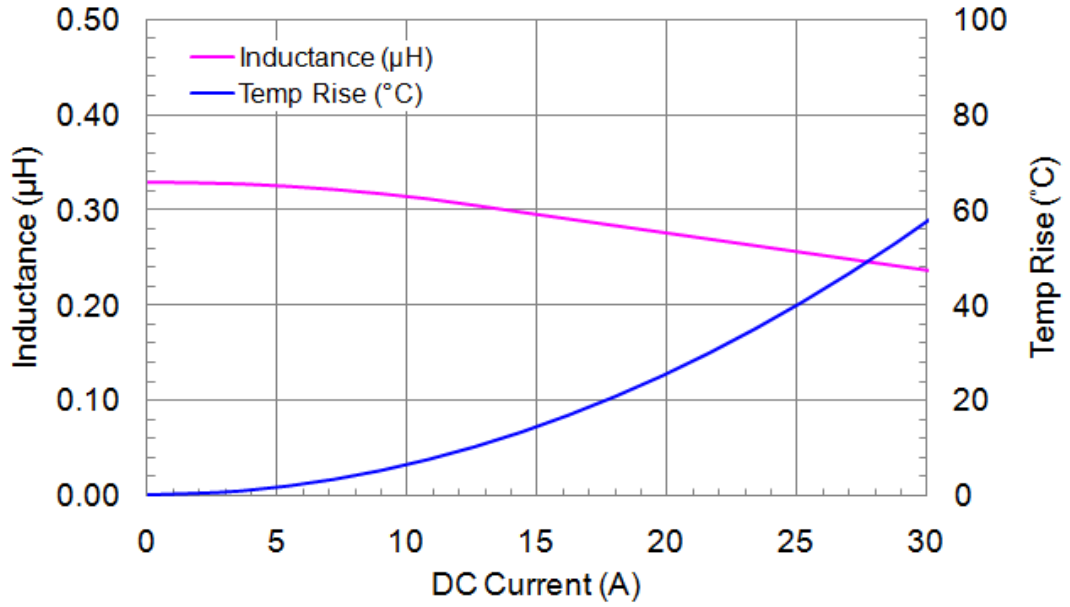



■ Product Dimension

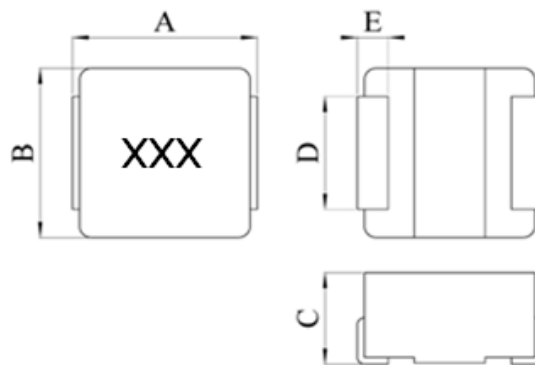

Code: XXX = R33 = 0.33  $\mu$ H

Dimension	A	B	C	D	E
Part number					
MND-06CZER33M-XB-RU	6.36 $\pm$ 0.2	6.56 $\pm$ 0.2	3.0 Max	4.7 $\pm$ 0.2	1.4 $\pm$ 0.5

Unit: mm

## ■ Recommended PCB Layout

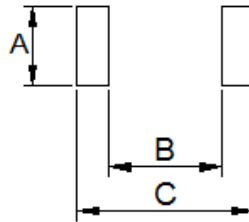

Type	06CZ
A	5.0
B	2.61
C	6.7

Unit: mm

### Safety precaution

1. Do not make any through holes and copper pattern in the dotted line area. Except a copper pattern to the electrode.
2. Don't design/mount any components in contact with this product.

This power choke do not have any protective function in abnormal condition such as overload, short circuit, open conditions and etc, it shall be confirmed as the end product that there is no risk of smoking, fire, dielectric withstand voltage, insulation resistance etc. in abnormal conditions to provide protective devices and/or protection circuit in the end product. It is recommended the temperature rise of choke during operation is less than 50°C.

## ■ Reliability Test

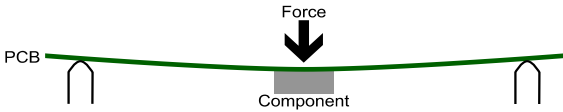
Electrical performance test		
Item	Specification	Test method
Inductance	Refer to the electrical specifications.	Measured with Keysight 4285A or equivalent.
DC Resistance		Measured with ADEX AX-1152D or equivalent.
Saturation current		DC current that will cause initial inductance drop (environment temperature of 25°C).
Heat rating current		DC current that will cause temperature rise (environment temperature of 25°C).
Mechanical performance test		
Item	Specification	Test method
Bending	Inductance variation within $\pm 10\%$	<p>Apply pressure gradually in the direction of the arrow at a rate of about 0.5mm/s until bent depth reaches 2mm and hold for 30 seconds.</p> <p>Board length/width: 40 x 100 mm, thickness: 1 mm.</p> 
Adhesion strength	Inductance variation within $\pm 10\%$	Apply 1.8 Kg force with R0.5mm pressing tool to the side of component for 60 +1 seconds.
Vibration	Inductance variation within $\pm 10\%$	The specimen be subjected to a vibration of 1.5 mm amplitude, sweep frequency 10 - 55 Hz (10 Hz to 55 Hz to 10Hz in a period of one minute) for 2 hours in each 3 (X, Y, Z) axes.
	Inductance variation	Drop on PCB from 100 cm height three times in X, Y, Z



Mechanical shock	Inductance variation within $\pm 10\%$	directions, the terminals shall be protected before dropping.
Solderability	New solder shall covered with 90 % minimum on the surface	Immerse electrodes in flux at room temperature then immerse in solder bath after preheat. Preheat: $160\pm 10^{\circ}\text{C}$ , $90\pm 3$ seconds. Soldering: $245\pm 5^{\circ}\text{C}$ , $3\pm 1$ seconds.



Resistance to soldering heat	Inductance variation within $\pm 10\%$	<p>IR reflow soldering method: Preheat: <math>150\sim 180^{\circ}\text{C}</math> for <math>90\sim 120</math> seconds. Peak temp: <math>260^{\circ}\text{C}</math> (over <math>230^{\circ}\text{C}</math> for <math>30\sim 40</math> seconds). The specimen shall be subjected to above IR reflow for 2 times. Test board: 0.8mm thickness FR4.</p> <p>Measurement: The specimen shall be stored at room temperature for 1 hour then measuring.</p>								
<b>Climatic test</b>										
Item	Specification	Test method								
High temperature exposure	Inductance variation within $\pm 10\%$	Place specimen in test chamber with $125^{\circ}\text{C}$ ambient temperature for 1,000 hours, then stabilize under room temperature for $24\pm 4$ hours before measurement.								
Temperature cycling	Inductance variation within $\pm 10\%$	<p>Place specimen in test chamber for 1,000 cycles, each temperature cycle as below:</p> <table border="1" style="margin-left: auto; margin-right: auto;"> <thead> <tr> <th>Temperature</th> <th>Duration</th> </tr> </thead> <tbody> <tr> <td><math>-55^{\circ}\text{C}</math></td> <td>30 minutes</td> </tr> <tr> <td><math>125^{\circ}\text{C}</math></td> <td>30 minutes</td> </tr> <tr> <td>Ramp: <math>-55\sim 125^{\circ}\text{C}</math></td> <td>&lt;1 minutes</td> </tr> </tbody> </table> <p>then stabilize under room temperature for <math>24\pm 4</math> hours before measurement.</p>	Temperature	Duration	$-55^{\circ}\text{C}$	30 minutes	$125^{\circ}\text{C}$	30 minutes	Ramp: $-55\sim 125^{\circ}\text{C}$	<1 minutes
Temperature	Duration									
$-55^{\circ}\text{C}$	30 minutes									
$125^{\circ}\text{C}$	30 minutes									
Ramp: $-55\sim 125^{\circ}\text{C}$	<1 minutes									
High temperature humidity	Inductance variation within $\pm 10\%$	Place specimen in test chamber with $85^{\circ}\text{C}$ , 85% relative humidity for 1,000 hours, then stabilize under room temperature for $24\pm 4$ hours before measurement.								

Operational life	Inductance variation within $\pm 10\%$	Place specimen in temperature controlled chamber then apply Idc. current and adjust ambient temperature until temperature of inductor reach $125^{\circ}\text{C}$ for 1,000 hours, then stabilize under room temperature for $24\pm 4$ hours before measurement.
------------------	--	--

**Note:**

Storage condition: the temperature should be within  $-40^{\circ}\text{C}\sim 85^{\circ}\text{C}$  and humidity should be less than 75%RH. The product should be used within 6 months from the time of delivery.



MND-06CZER33M-XB-RU

9 of 12

■ **Packaging**

**Peel-off force**



The peel off force of cover tape is 10 to 70 grams in the arrow direction.

**Dimensions**

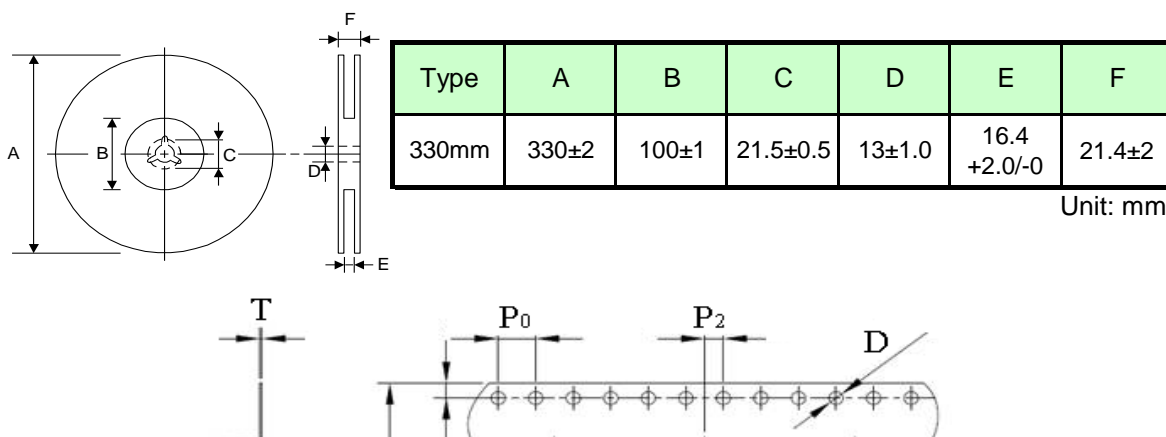

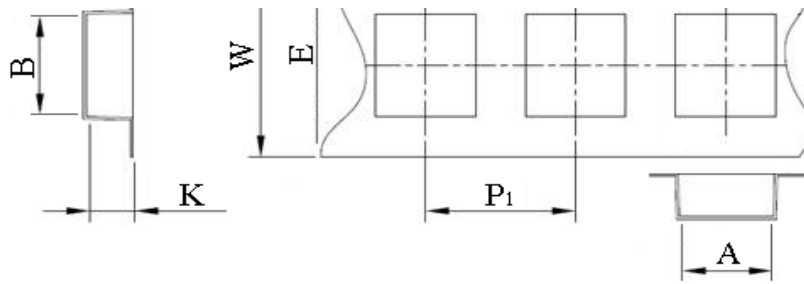

TYPE	SIZE	A	B	W	P <sub>1</sub>	K
MND	06CZ	6.8±0.1	7.1±0.1	16.0±0.3	12.0±0.1	3.4±0.1
		P <sub>0</sub>	P <sub>2</sub>	D	E	T
		4.0±0.1	2.0±0.1	1.5±0.1	1.75±0.1	0.35±0.05

Unit: mm



**MAG.LAYERS**

MND-06CZER33M-XB-RU

10 of 12

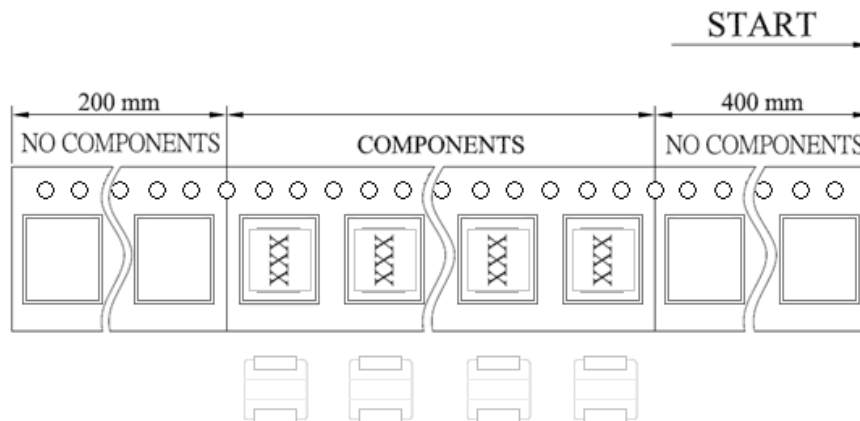

**Taping quantity**

Series	06CZ
PCS/Reel	1000



■ Recommended Reflow Soldering Profile

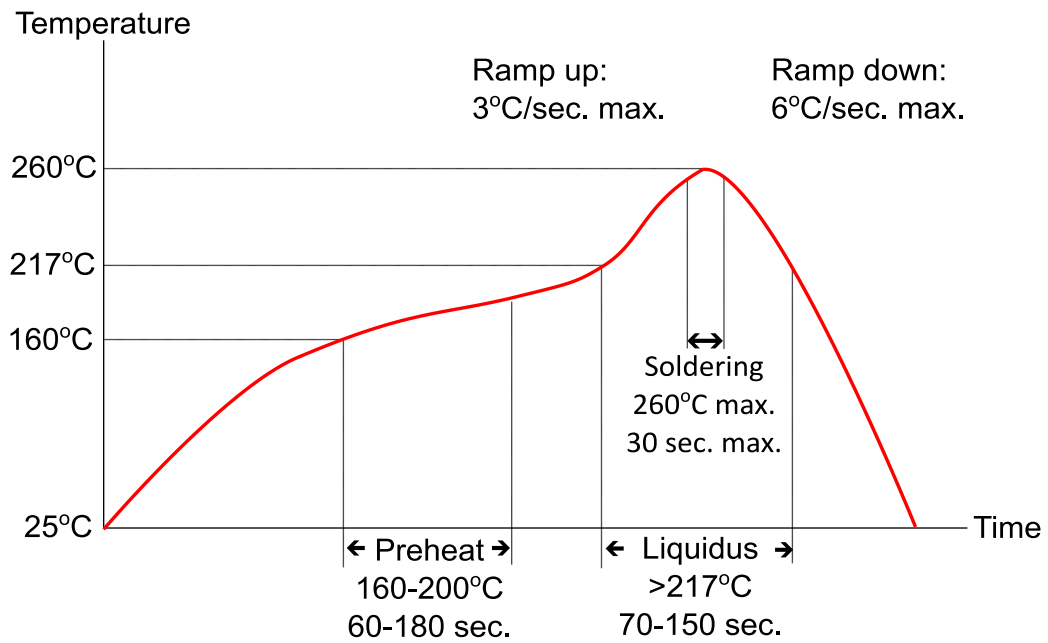

1. IR reflow soldering:

Ramp up rate: 3°C per second (max.)

Ramp down rate: 6°C per second (max.)

Preheat temperature: 160-200°C, 60-180 seconds  
Liquidus temperature: above 217°C, 70-150 seconds  
Peak temperature: 260°C (max.), 30 seconds (max.)

## 2. Rework flow:

Component can withstand 3 IR reflow cycles with a cool down between each cycle.

### ■ Notes

The contents of this data sheet are subject to change without notice, please confirm the specifications and delivery conditions when placing your order.



**MAG.LAYERS**

---

MND-06CZER33M-XB-RU