

## Features

- Attenuation: 1 dB Steps to 15 dB
- Low DC Power Consumption
- Small Footprint, JEDEC Package
- Integral TTL Driver
- 50 Ohm Impedance
- Test Boards Available
- Tape and Reel Packaging Available
- Lead-Free CSP-1 Package
- 100% Matte Tin Plating over Copper
- Halogen-Free “Green” Mold Compound
- 260°C Reflow Compatible
- RoHS\* Compliant Version of AT90-0413

## Description

M/A-COM’s MAADCC0006 is a GaAs FET 4-Bit digital attenuator with integral driver. Step size is 1 dB providing a 15 dB attenuation range. This device is in an PQFN plastic surface mount package. The MAADCC0006 is suited for applications where accuracy, fast speed, low power consumption and low costs are required.

## Schematic with Off-Chip Components

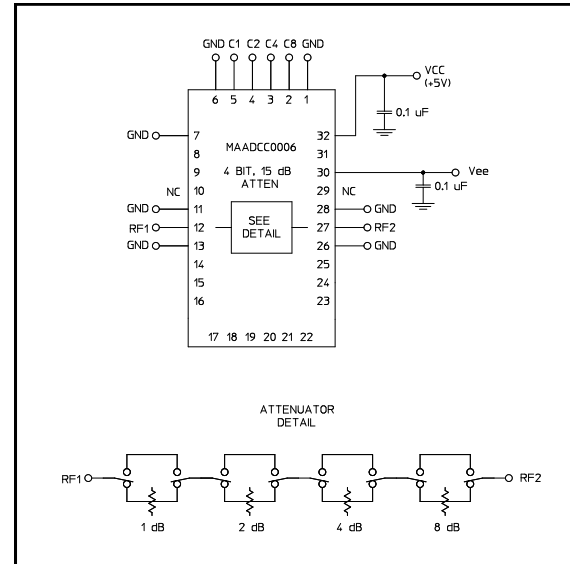

## Pin Configuration<sup>2</sup>

Pin No.	Function	Pin No.	Function
1	GND	17	N/C
2	C8	18	N/C
3	C4	19	N/C
4	C2	20	N/C
5	C1	21	N/C
6	GND	22	N/C
7	GND	23	N/C
8	N/C	24	N/C
9	N/C	25	N/C
10	N/C <sup>1</sup>	26	GND
11	GND	27	RF2
12	RF1	28	GND
13	GND	29	N/C <sup>1</sup>
14	N/C	30	Vee
15	N/C	31	N/C
16	N/C	32	+Vcc

1. Pins 10 & 29 must be isolated.
2. The exposed pad centered on the package bottom must be connected to RF and DC ground. (For PQFN Packages)

## Ordering Information

Part Number	Package
MAADCC0006	Bulk Packaging
MAADCC0006TR	1000 piece reel
MAADCC0006-TB	Sample Test Board

Note: Reference Application Note M513 for reel size information.

\* Restrictions on Hazardous Substances, European Union Directive 2002/95/EC.

## Digital Attenuator 15.0 dB, 4-Bit, TTL Driver, DC-4.0 GHz

Rev. V5

### Electrical Specifications: $T_A = 25^\circ\text{C}$

Parameter	Test Conditions	Frequency	Units	Min	Typ	Max
Insertion Loss	—	DC-2.5 GHz	dB	—	2.0	2.5
		DC-4.0 GHz	dB	—	2.5	3.0
Attenuation Accuracy	Individual Bits or Combination of Bits	DC-2.5 GHz	dB	—	—	$\pm(0.3+4\%$ of atten setting)
		DC-4.0 GHz	dB	—	—	$\pm(0.3+6\%$ of atten setting)
VSWR	Full Attenuation Range	DC-2.5 GHz	Ratio	—	1.5:1	1.8:1
		DC-4.0 GHz	Ratio	—	1.8:1	2.0:1
Switching Speed	50% Cntl to 90%/10% RF 10% to 90% or 90% to 10%	—	ns	—	25	—
		—	ns	—	4	—
1 dB Compression	—	50 MHz	dB	—	+21	—
		0.5-4.0 GHz	dB	—	+27	—
Input $IP_3$	Two-tone Inputs up to +5 dBm	50 MHz	dB	—	+35	—
		0.5-4.0 GHz	dB	—	+48	—
+Vcc	—	—	V	4.75	5.0	5.25
-Vee	—	—	V	-8.0	-5.0	-4.75
$V_{IL}$ $V_{IH}$	LOW-level input voltage HIGH-level input voltage	—	V	0.0	—	0.8
		—	V	2.0	—	5.0
$I_{in}$ (Input Leakage Current)	$V_{in} = V_{CC}$ or GND	—	$\mu\text{A}$	-1.0	—	1.0
$I_{cc}$ (Quiescent Supply Current)	$V_{cntrl} = V_{CC}$ or GND	—	$\mu\text{A}$	—	250	400
$\Delta I_{cc}$ (Additional Supply Current Per TTL Input Pin)	$V_{CC} = \text{Max}$ , $V_{cntrl} = V_{CC} - 2.1\text{ V}$	—	mA	—	—	1.5
IEE	$V_{EE}$ min to max, $V_{in} = V_{IL}$ or $V_{IH}$	—	mA	-1.0	-0.2	—
Thermal Resistance $\theta_{jc}$	—	—	$^\circ\text{C/W}$	—	15	—

### Absolute Maximum Ratings<sup>3,4</sup>

Parameter	Absolute Maximum
Max. Input Power 0.05 GHz 0.5 - 4.0 GHz	+27 dBm +34 dBm
$V_{CC}$	$-0.5\text{ V} \leq V_{CC} \leq +7.0\text{ V}$
$V_{EE}$	$-8.5\text{ V} \leq V_{EE} \leq +0.5\text{ V}$
$V_{CC} - V_{EE}$	$-0.5\text{ V} \leq V_{CC} - V_{EE} \leq 14.5\text{ V}$
$V_{in}^5$	$-0.5\text{ V} \leq V_{in} \leq V_{CC} + 0.5\text{ V}$
Operating Temperature	$-40^\circ\text{C}$ to $+85^\circ\text{C}$
Storage Temperature	$-65^\circ\text{C}$ to $+125^\circ\text{C}$

- Exceeding any one or combination of these limits may cause permanent damage to this device.
- M/A-COM does not recommend sustained operation near these survivability limits.
- Standard CMOS TTL interface, latch-up will occur if logic signal applied prior to power supply.

### Recommended PCB Configuration<sup>6</sup>

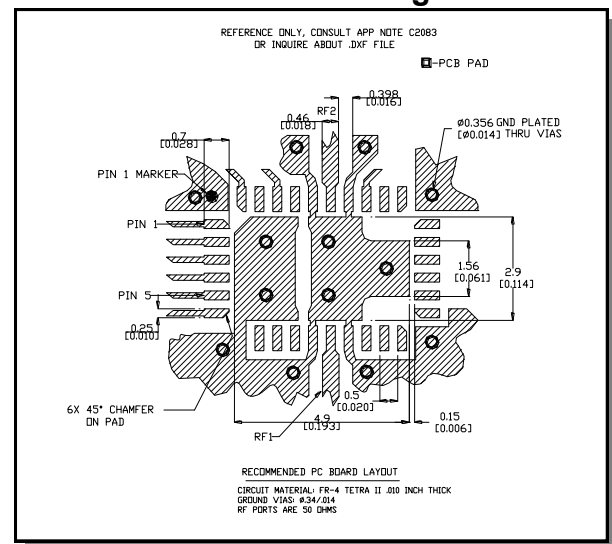

- Application Note S2083 is available on line at [www.macom.com](http://www.macom.com)

M/A-COM Technology Solutions Inc. (MACOM) and its affiliates reserve the right to make changes to the product(s) or information contained herein without notice. Visit [www.macom.com](http://www.macom.com) for additional data sheets and product information.

## Handling Procedures

Please observe the following precautions to avoid damage:

## Static Sensitivity

Gallium Arsenide Integrated Circuits are sensitive to electrostatic discharge (ESD) and can be damaged by static electricity. Proper ESD control techniques should be used when handling these devices.

## Moisture Sensitivity

The MSL rating for this part is defined as Level 2 per IPC/JEDEC J-STD-020. Parts shall be stored and/or baked as required for MSL Level 2 parts.

## Truth Table (Digital Attenuator)

C8	C4	C2	C1	Attenuation
0	0	0	0	Loss, Reference
0	0	0	1	1.0 dB
0	0	1	0	2.0 dB
0	1	0	0	4.0 dB
1	0	0	0	8.0 dB
1	1	1	1	15.0 dB

0 = TTL Low. 1 = TTL High

## Typical Performance Curves

Reference Loss vs. Frequency

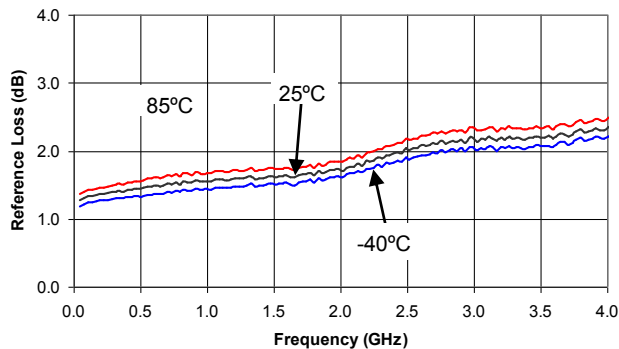

Attenuation - 1 dB Bit vs. Frequency

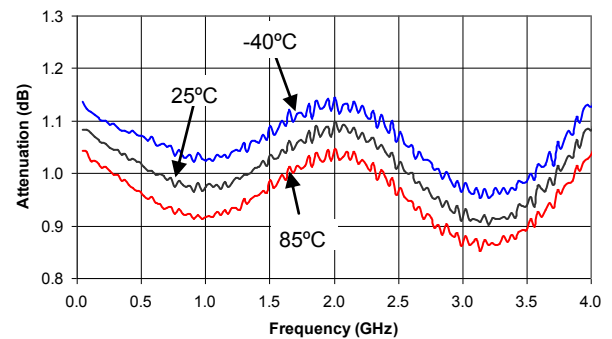

Attenuation - 2 dB Bit vs. Frequency

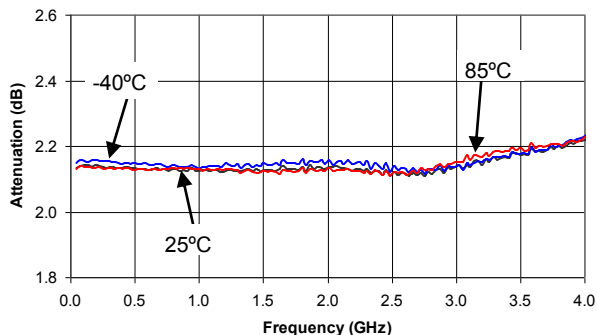

Attenuation - 4dB Bit vs. Frequency

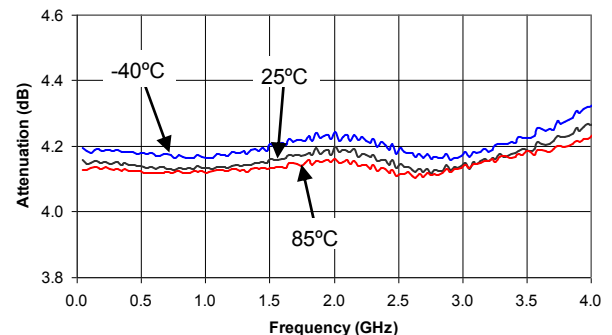

## Typical Performance Curves

**Attenuation - 8 dB Bit vs. Frequency**

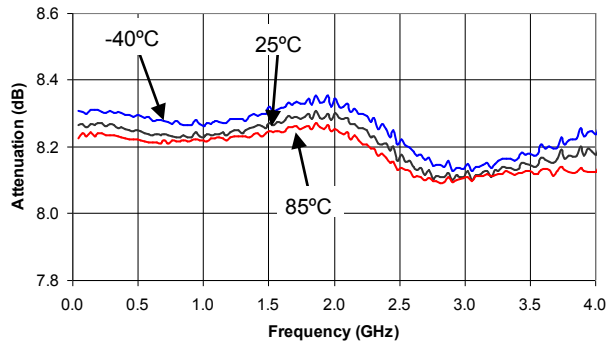

**Attenuation - 15 dB Attenuation vs. Frequency**

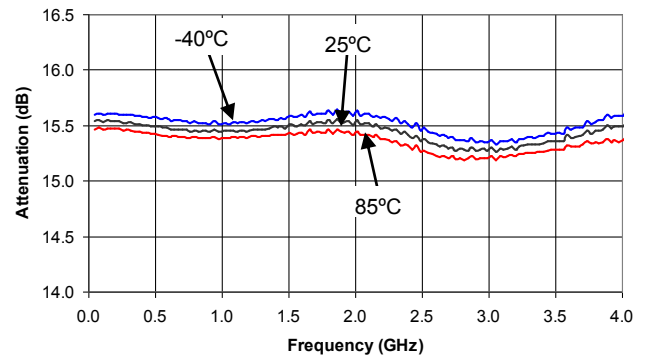

**VSWR vs. Frequency**  
**Reference Loss State**

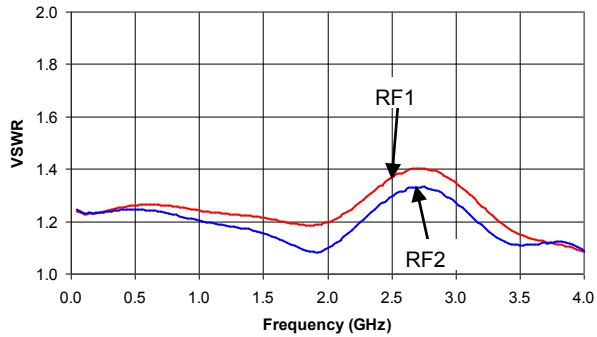

**VSWR - 1 dB Bit vs. Frequency**

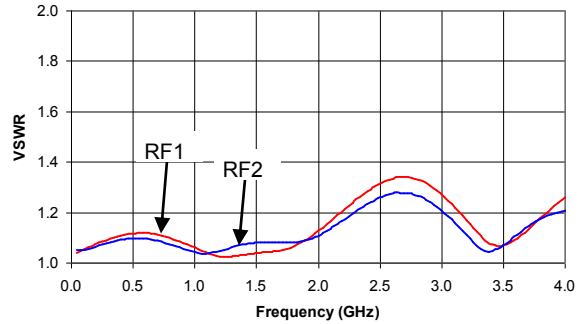

**VSWR - 2 dB Bit vs. Frequency**

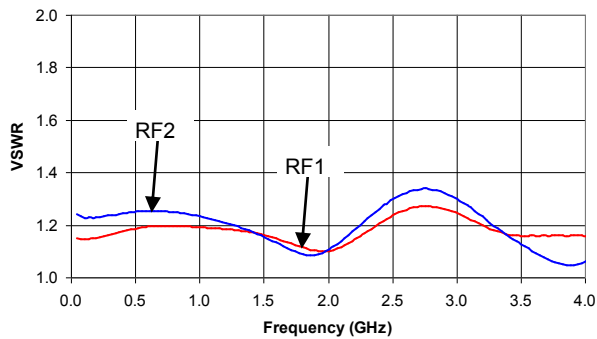

**VSWR - 4 dB Bit vs. Frequency**

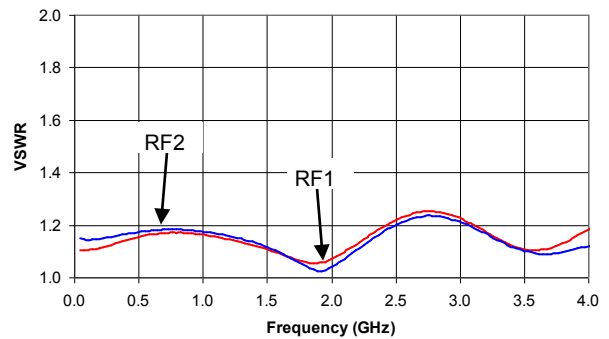

## Digital Attenuator 15.0 dB, 4-Bit, TTL Driver, DC-4.0 GHz

Rev. V5

### Typical Performance Curves

VSWR - 8 dB Bit vs. Frequency

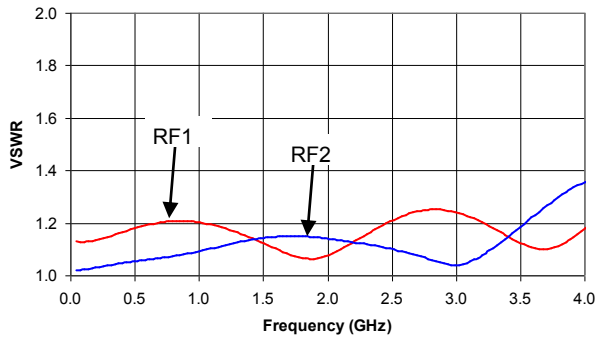

VSWR - 15 dB Attenuation vs. Frequency

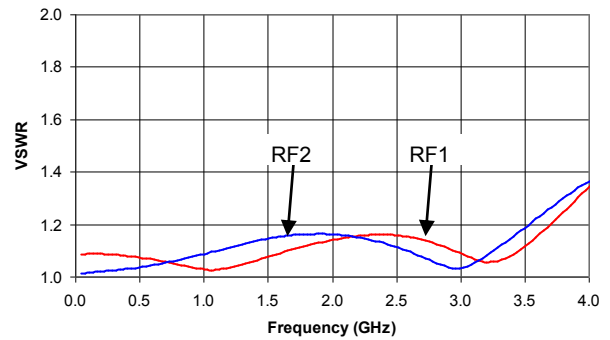

### CSP-1, Lead-Free 4 x 6 mm, 32-lead PQFN†

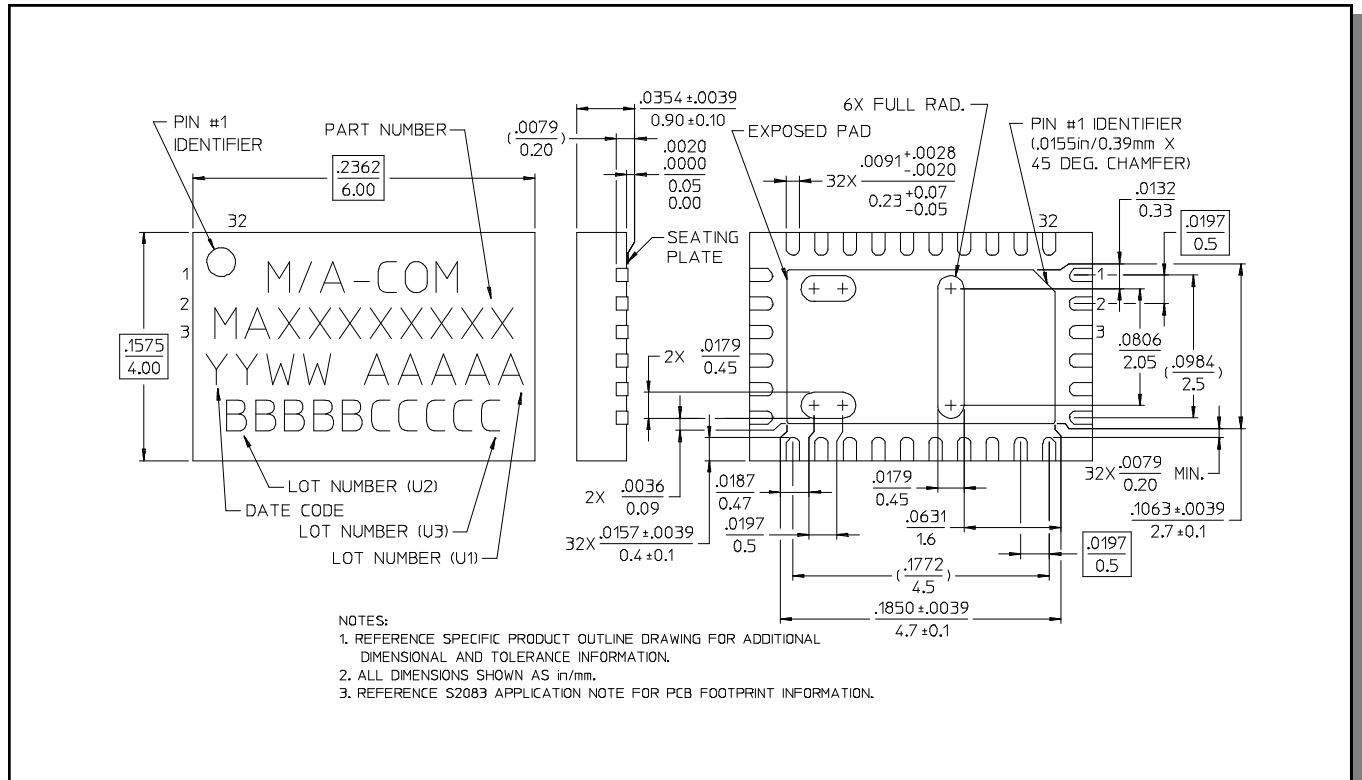

† Reference Application Note M538 for lead-free solder reflow recommendations.

M/A-COM Technology Solutions Inc. All rights reserved.

Information in this document is provided in connection with M/A-COM Technology Solutions Inc ("MACOM") products. These materials are provided by MACOM as a service to its customers and may be used for informational purposes only. Except as provided in MACOM's Terms and Conditions of Sale for such products or in any separate agreement related to this document, MACOM assumes no liability whatsoever. MACOM assumes no responsibility for errors or omissions in these materials. MACOM may make changes to specifications and product descriptions at any time, without notice. MACOM makes no commitment to update the information and shall have no responsibility whatsoever for conflicts or incompatibilities arising from future changes to its specifications and product descriptions. No license, express or implied, by estoppel or otherwise, to any intellectual property rights is granted by this document.

THESE MATERIALS ARE PROVIDED "AS IS" WITHOUT WARRANTY OF ANY KIND, EITHER EXPRESS OR IMPLIED, RELATING TO SALE AND/OR USE OF MACOM PRODUCTS INCLUDING LIABILITY OR WARRANTIES RELATING TO FITNESS FOR A PARTICULAR PURPOSE, CONSEQUENTIAL OR INCIDENTAL DAMAGES, MERCHANTABILITY, OR INFRINGEMENT OF ANY PATENT, COPYRIGHT OR OTHER INTELLECTUAL PROPERTY RIGHT. MACOM FURTHER DOES NOT WARRANT THE ACCURACY OR COMPLETENESS OF THE INFORMATION, TEXT, GRAPHICS OR OTHER ITEMS CONTAINED WITHIN THESE MATERIALS. MACOM SHALL NOT BE LIABLE FOR ANY SPECIAL, INDIRECT, INCIDENTAL, OR CONSEQUENTIAL DAMAGES, INCLUDING WITHOUT LIMITATION, LOST REVENUES OR LOST PROFITS, WHICH MAY RESULT FROM THE USE OF THESE MATERIALS.

MACOM products are not intended for use in medical, lifesaving or life sustaining applications. MACOM customers using or selling MACOM products for use in such applications do so at their own risk and agree to fully indemnify MACOM for any damages resulting from such improper use or sale.