

CMPA801B030S

7.9 - 11.0 GHz, 40 W, Packaged GaN MMIC
Power Amplifier

Description

WolfSpeed's CMPA801B030S is a packaged, 40W HPA utilizing WolfSpeed's high performance, 0.15μm GaN-on-Silicon Carbide production process. The CMPA801B030S operates from 7.9 - 11.0 GHz and targets pulsed radar systems supporting both defense and commercial applications. With 2 stages of gain, this high performance amplifier provides 20dB of large signal gain and 40% efficiency to support lower system DC power requirements and simplify system thermal management solutions. Packaged in a 7x7 mm plastic overmold QFN, the CMPA801B030S also supports reduced board space requirements and high-throughput manufacturing lines.

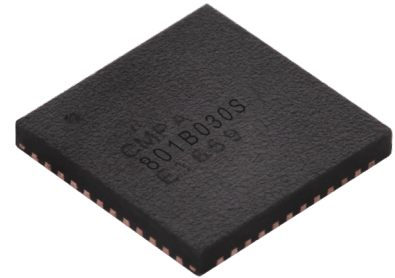

Package Type: 7x7 QFN
PN:CMPA801B030S

Typical Performance Over 7.9 - 11.0 GHz (T_c = 25°C)

Parameter	8.0 GHz	8.5 GHz	9.0 GHz	10.0 GHz	11.0 GHz	Units
Small Signal Gain	28.2	27.5	27.1	24.6	24.0	dB
Output Power	39.3	45.9	48.9	42.3	40.7	W
Power Gain	19.9	20.6	21.0	20.3	20.1	dB
Power Added Efficiency	38.2	40.6	41.3	39.4	37.0	%

Note: P_{IN} = 26 dBm, Pulse Width = 100μs; Duty Cycle = 10%

Features

- Freq: 7.9 – 11.0 GHz
- P_{SAT}: 40 W
- PAE: 40%
- LS Gain: 20 dB
- 7x7 mm Overmold QFN
- Lower system costs
- Reduced board area

Applications

- Military pulsed radar
- Civil pulsed radar
- Satellite Communications

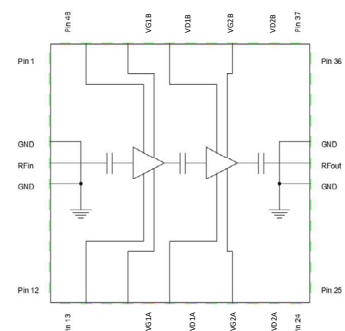

Note:

Features are typical performance across frequency under 25°C operation.
Please reference performance charts for additional details.





Absolute Maximum Ratings (not simultaneous) at 25°C

Parameter	Symbol	Rating	Units	Conditions
Drain-source Voltage	V_{DSS}	84	V_{DC}	25°C
Gate-source Voltage	V_{GS}	-10, +2		
Storage Temperature	T_{STG}	-65, +150	°C	
Maximum Forward Gate Current	I_G	12	mA	25°C
Maximum Drain Current	I_{DMAX}	6	A	
Soldering Temperature	T_S	260	°C	

Electrical Characteristics (Frequency = 7.9 GHz to 11.0 GHz unless otherwise stated; $T_c = 25^\circ\text{C}$)

Characteristics	Symbol	Min.	Typ.	Max.	Units	Conditions
DC Characteristics						
Gate Threshold Voltage	$V_{GS(th)}$	-2.6	—	-1.6	V	$V_{DS} = 10\text{ V}, I_D = 13\text{ mA}$
Gate Quiescent Voltage	$V_{GS(Q)}$	—	-1.75	—	V_{DC}	$V_{DD} = 28\text{ V}, I_{DQ} = 800\text{ mA}$
Saturated Drain Current ¹	I_{DS}	—	4	—	A	$V_{DS} = 6.0\text{ V}, V_{GS} = 2.0\text{ V}$
Drain-Source Breakdown Voltage	V_{BD}	84	—	—	V	$V_{GS} = -8\text{ V}, I_D = 13\text{ mA}$
RF Characteristics^{2,3}						
Small Signal Gain at 8.0 GHz	S_{21_1}	—	28.2	—	dB	$V_{DD} = 28\text{ V}, I_{DQ} = 800\text{ mA}$
Small Signal Gain at 8.5 GHz	S_{21_2}	—	27.5	—		
Small Signal Gain at 9.0 GHz	S_{21_3}	—	27.1	—		
Small Signal Gain at 10.0 GHz	S_{21_4}	—	24.6	—		
Small Signal Gain at 11.0 GHz	S_{21_5}	—	24.0	—		
Output Power at 8.0 GHz	P_{OUT1}	—	39.3	—	W	$V_{DD} = 28\text{ V}, I_{DQ} = 800\text{ mA}, P_{IN} = 26\text{ dBm}$
Output Power at 8.5 GHz	P_{OUT2}	—	45.9	—		
Output Power at 9.0 GHz	P_{OUT3}	—	48.9	—		
Output Power at 10.0 GHz	P_{OUT4}	—	42.3	—		
Output Power at 11.0 GHz	P_{OUT5}	—	40.7	—		
Power Added Efficiency at 8.0 GHz	PAE_1	—	38	—	%	$V_{DD} = 28\text{ V}, I_{DQ} = 800\text{ mA}, P_{IN} = 26\text{ dBm}$
Power Added Efficiency at 8.5 GHz	PAE_2	—	41	—		
Power Added Efficiency at 9.0 GHz	PAE_3	—	—	—		
Power Added Efficiency at 10.0 GHz	PAE_4	—	39	—		
Power Added Efficiency at 11.0 GHz	PAE_5	—	37	—		
Power Gain	G_P	—	21.0	—	dB	$V_{DD} = 28\text{ V}, I_{DQ} = 800\text{ mA}$
Input Return Loss	S_{11}	—	-13	—		
Output Return Loss	S_{12}	—	-10	—		
Output Mismatch Stress	VSWR	—	—	5:1	Ψ	No damage at all phase angles, $V_{DD} = 28\text{ V}, I_{DQ} = 800\text{ mA}$

Notes:

¹ Scaled from PCM data

² All data pulse tested in CMPA801B030S-AMP1

³ Pulse Width = 100 μs ; Duty Cycle = 10%



Thermal Characteristics

Parameter	Symbol	Rating	Units	Conditions
Operating Junction Temperature	T_J	225	$^{\circ}\text{C}$	
Thermal Resistance, Junction to Case (packaged) ¹	$R_{\theta JC}$	2.5	$^{\circ}\text{C}/\text{W}$	100 μs , 10%, $P_{\text{DISS}} = 25.5 \text{ W}$

Notes:

¹ Measured for the CMPA801B030S at $P_{\text{DISS}} = 25.5 \text{ W}$

Typical Performance of the CPMA801B030S

Test conditions unless otherwise noted: $V_D = 28\text{ V}$, $I_{DQ} = 800\text{ mA}$, $PW = 100\mu\text{s}$, $DC = 10\%$, $P_{IN} = 26\text{ dBm}$, $T_{BASE} = +25^\circ\text{C}$

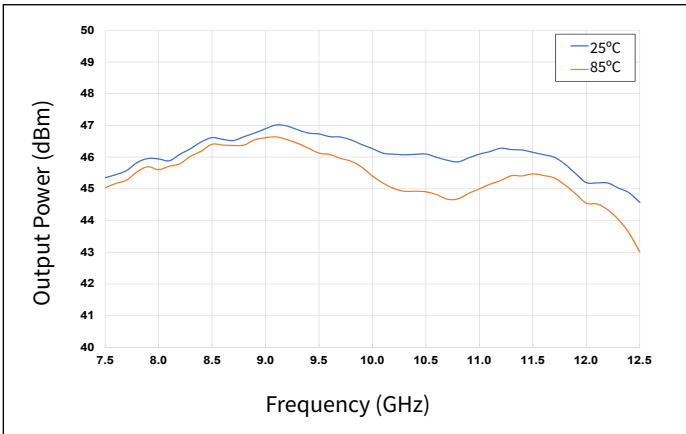

Figure 1. Output Power vs Frequency as a Function of Temperature

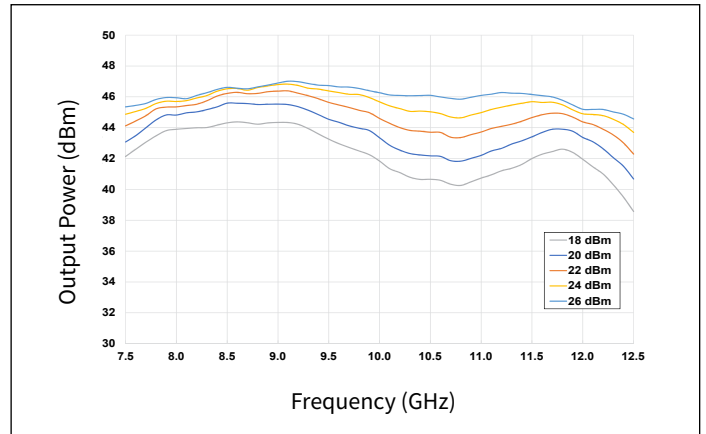

Figure 2. Output Power vs Frequency as a Function of Input Power

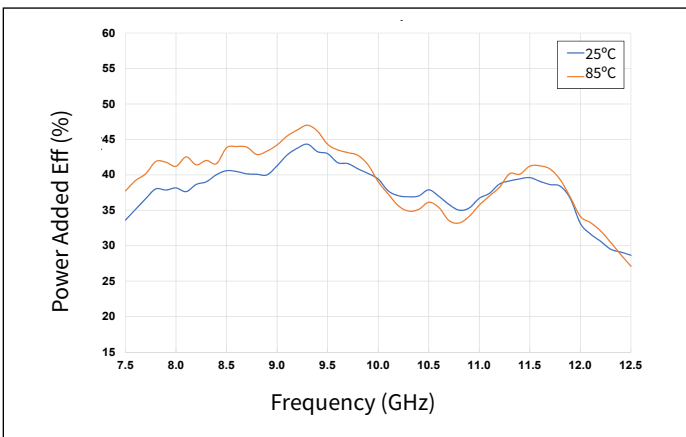

Figure 3. Power Added Eff. vs Frequency as a Function of Temperature

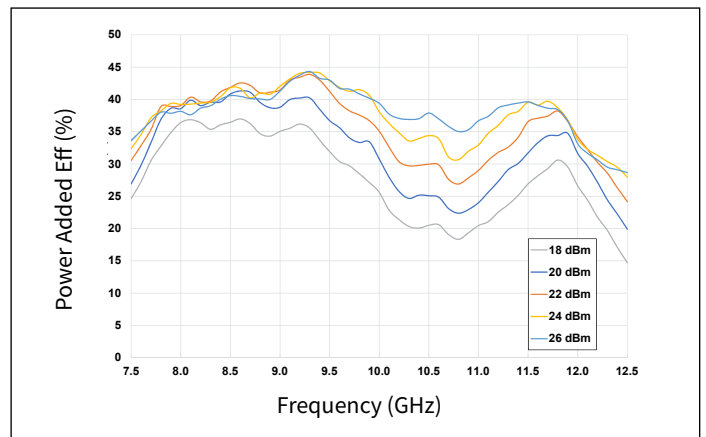

Figure 4. Power Added Eff. vs Frequency as a Function of Input Power

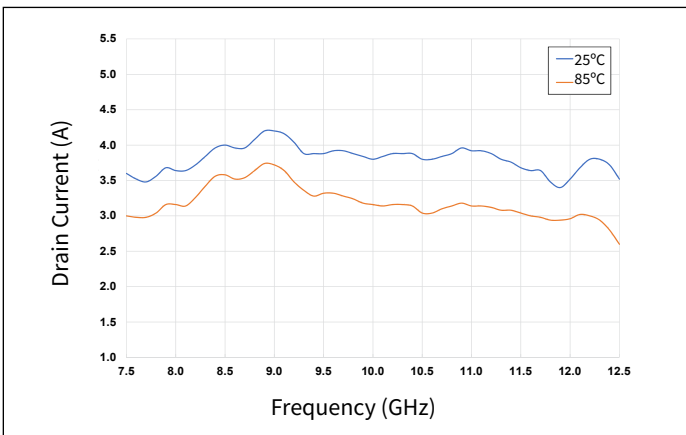

Figure 5. Drain Current vs Frequency as a Function of Temperature

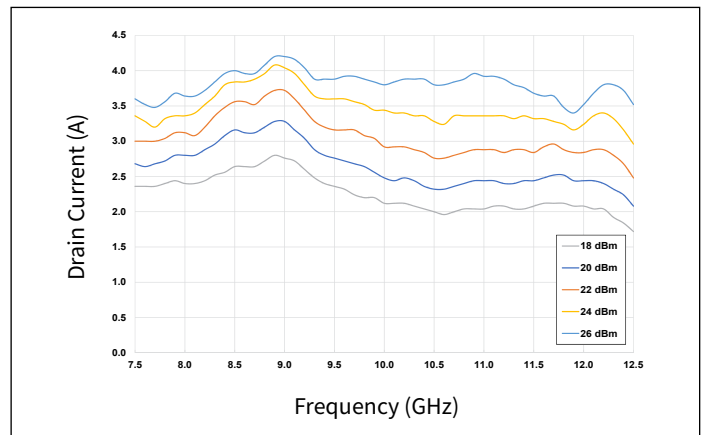

Figure 6. Drain Current vs Frequency as a Function of Input Power

Typical Performance of the CMPA801B030S

Test conditions unless otherwise noted: $V_D = 28\text{ V}$, $I_{DQ} = 800\text{ mA}$, $PW = 100\mu\text{s}$, $DC = 10\%$, $P_{IN} = 26\text{ dBm}$, $T_{BASE} = +25^\circ\text{C}$

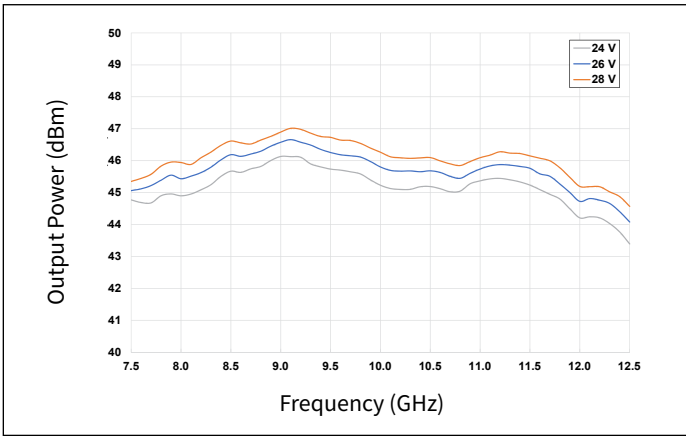

Figure 7. Output Power vs Frequency as a Function of V_D

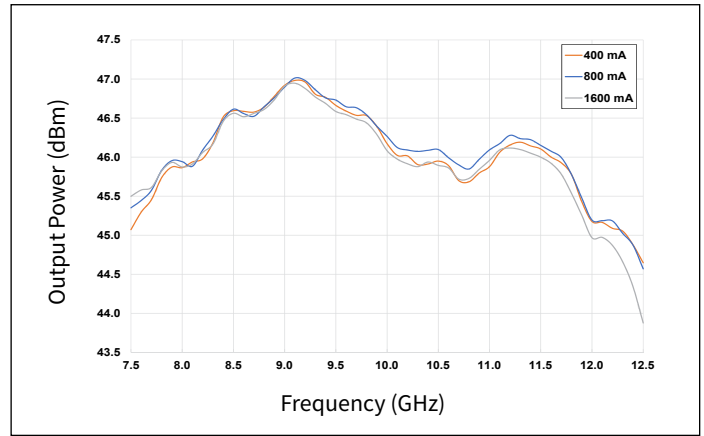

Figure 8. Output Power vs Frequency as a Function of I_{DQ}

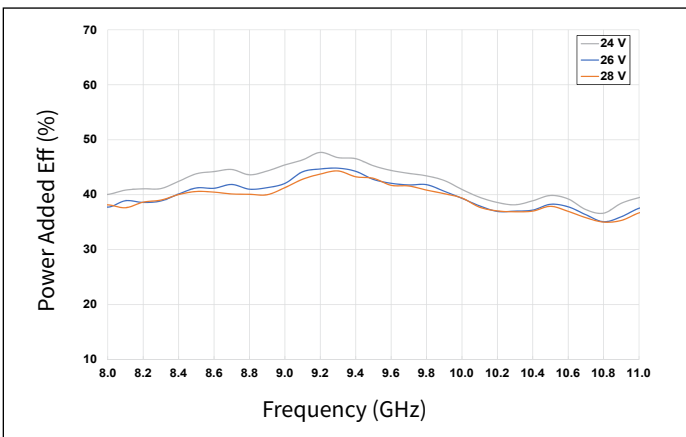

Figure 9. Power Added Eff. vs Frequency as a Function of V_D

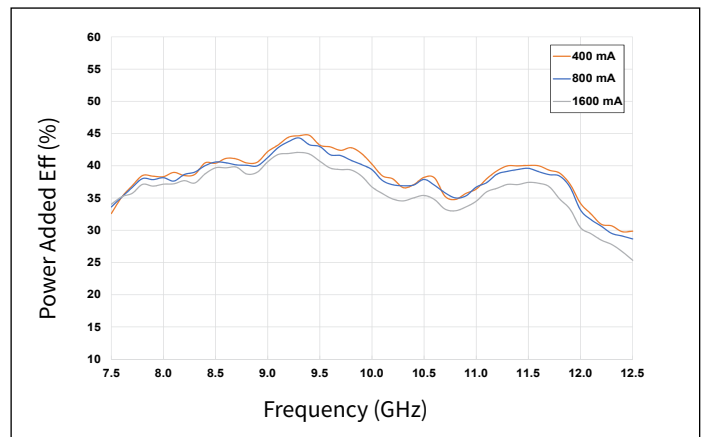

Figure 10. Power Added Eff. vs Frequency as a Function of I_{DQ}

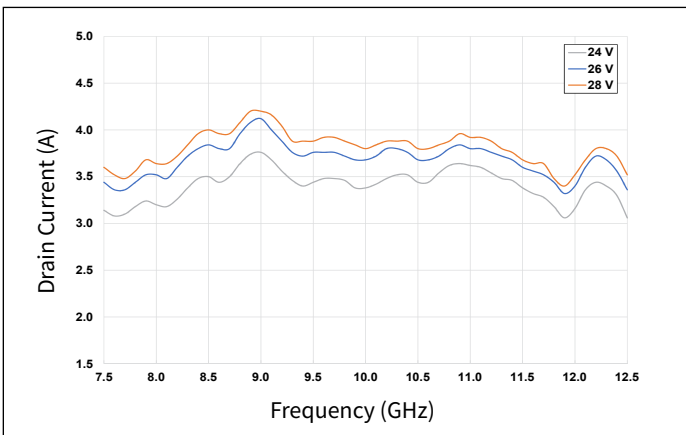

Figure 11. Drain Current vs Frequency as a Function of V_D

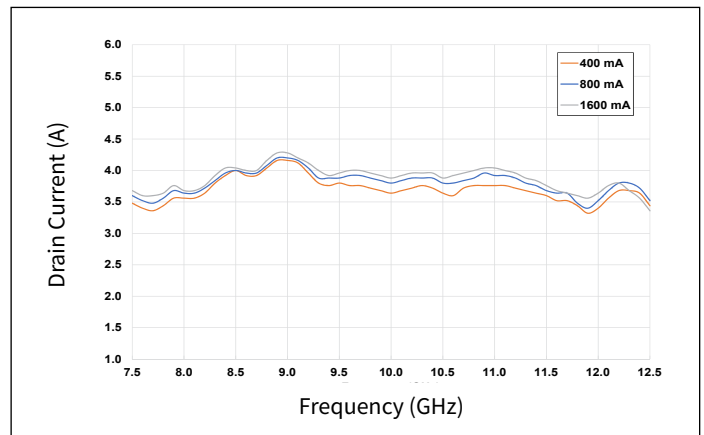

Figure 12. Drain Current vs Frequency as a Function of I_{DQ}

Typical Performance of the CMPA801B030S

Test conditions unless otherwise noted: $V_D = 28\text{ V}$, $I_{DQ} = 800\text{ mA}$, $PW = 100\mu\text{s}$, $DC = 10\%$, $P_{IN} = 26\text{ dBm}$, $T_{BASE} = +25^\circ\text{C}$

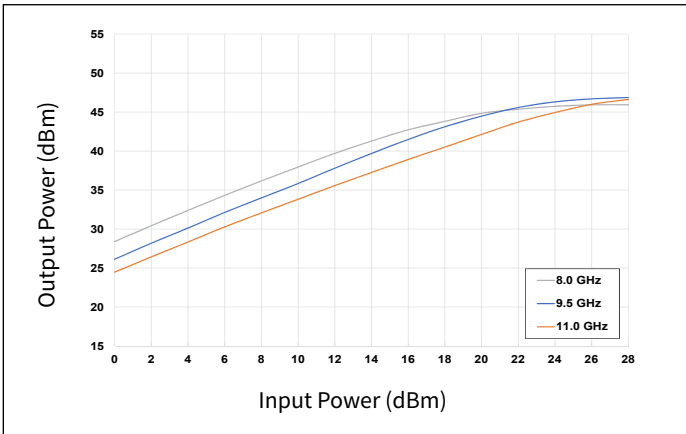

Figure 13. Output Power vs Input Power as a Function of Frequency

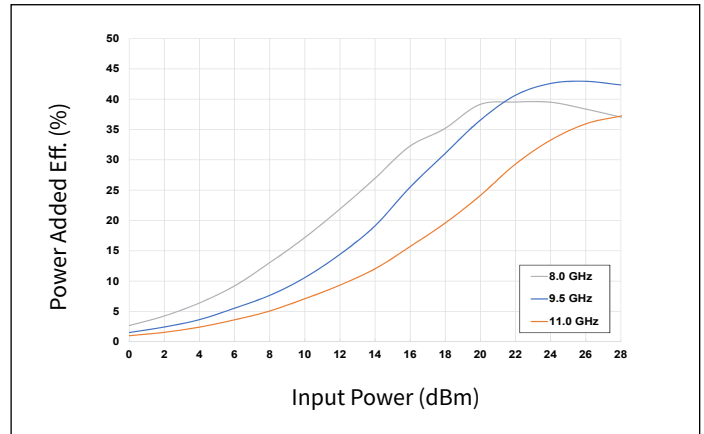

Figure 14. Power Added Eff. vs Input Power as a Function of Frequency

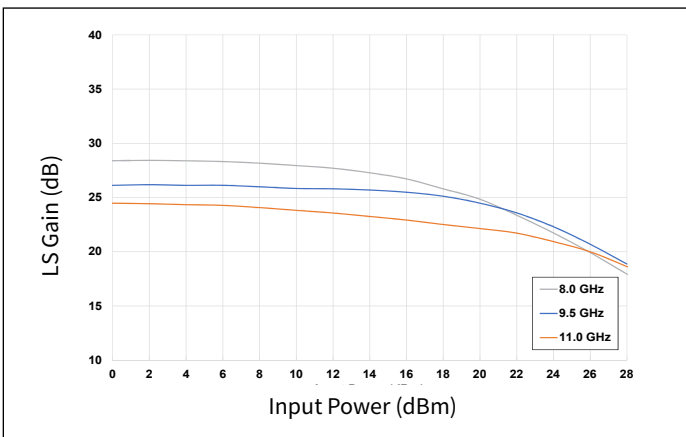

Figure 15. Large Signal Gain vs Input Power as a Function of Frequency

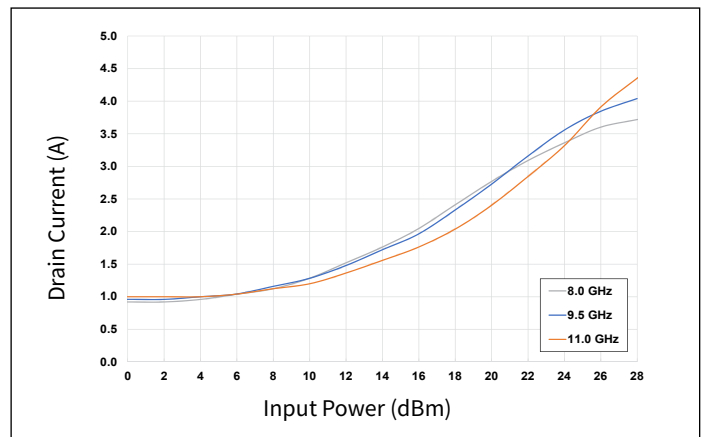

Figure 16. Drain Current vs Input Power as a Function of Frequency

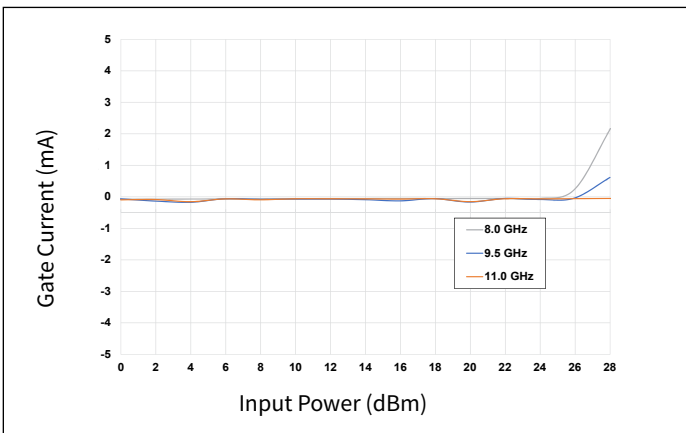

Figure 17. Gate Current vs Input Power as a Function of Frequency



Typical Performance of the CMPA801B030S

Test conditions unless otherwise noted: $V_D = 28\text{ V}$, $I_{DQ} = 800\text{ mA}$, $PW = 100\mu\text{s}$, $DC = 10\%$, $P_{IN} = 26\text{ dBm}$, $T_{BASE} = +25^\circ\text{C}$

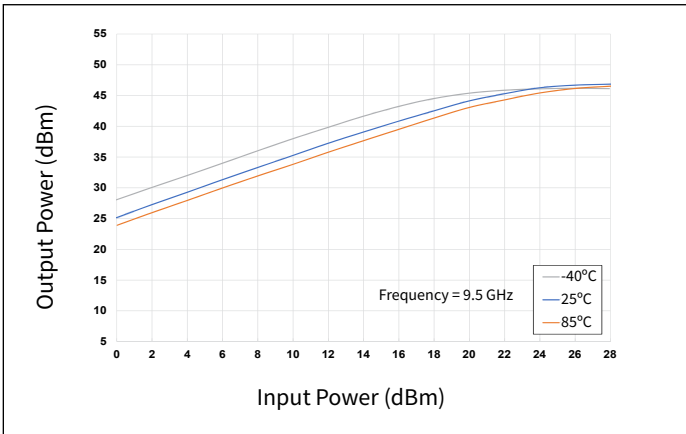

Figure 18. Output Power vs Input Power as a Function of Temperature

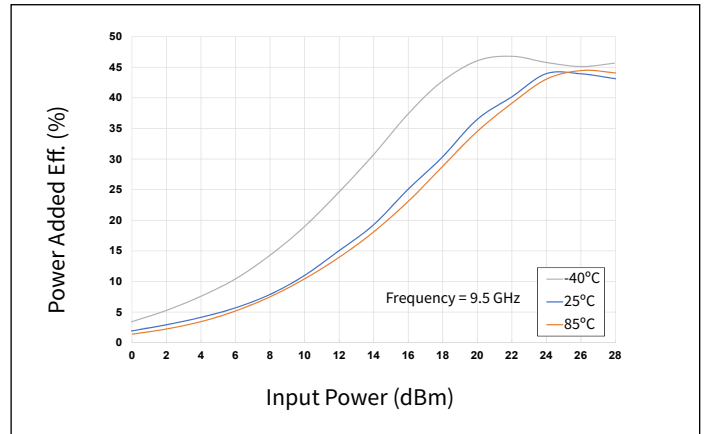

Figure 19. Power Added Eff. vs Input Power as a Function of Temperature

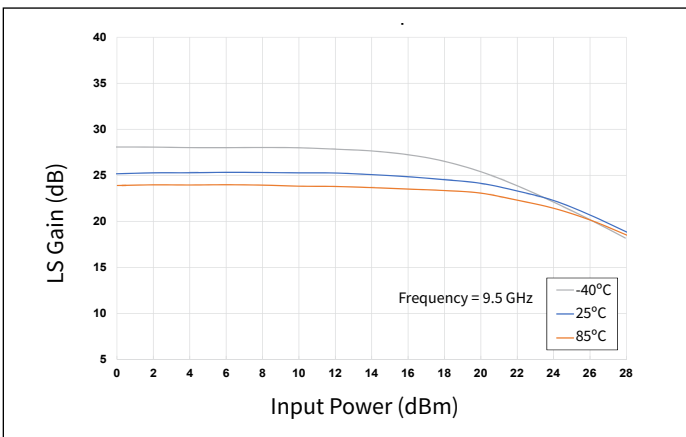

Figure 20. Large Signal Gain vs Input Power as a Function of Temperature

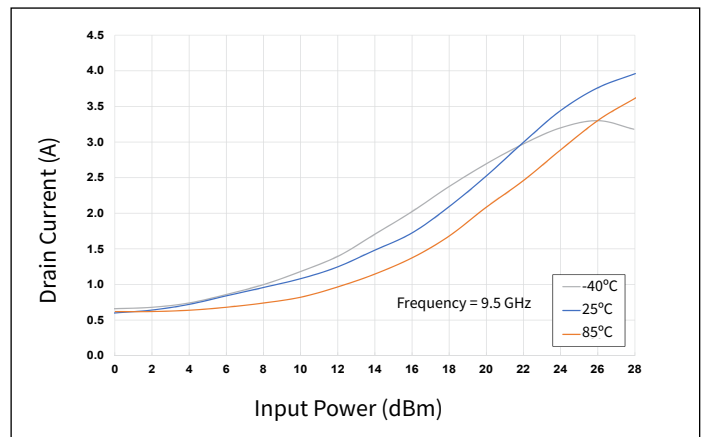

Figure 21. Drain Current vs Input Power as a Function of Temperature

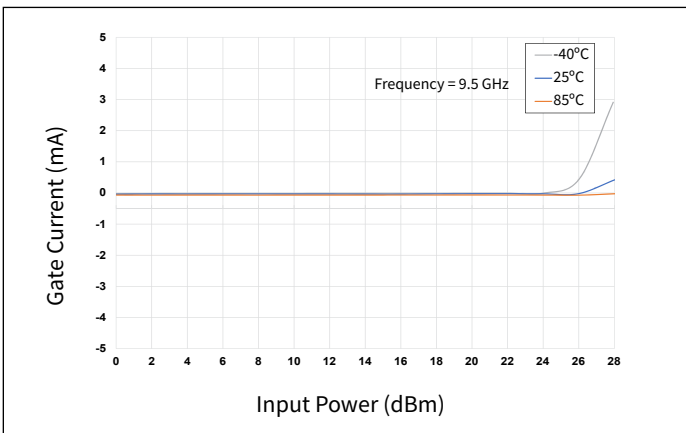

Figure 22. Gate Current vs Input Power as a Function of Temperature

Typical Performance of the CMPA801B030S

Test conditions unless otherwise noted: $V_D = 28\text{ V}$, $I_{DQ} = 800\text{ mA}$, $PW = 100\mu\text{s}$, $DC = 10\%$, $P_{IN} = 26\text{ dBm}$, $T_{BASE} = +25^\circ\text{C}$

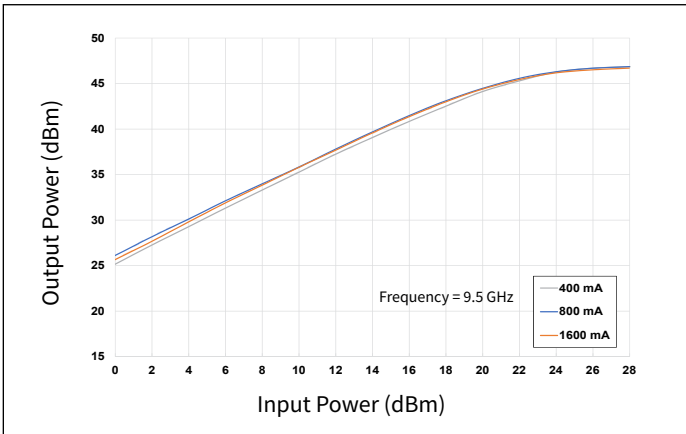

Figure 23. Output Power vs Input Power as a Function of I_{DQ}

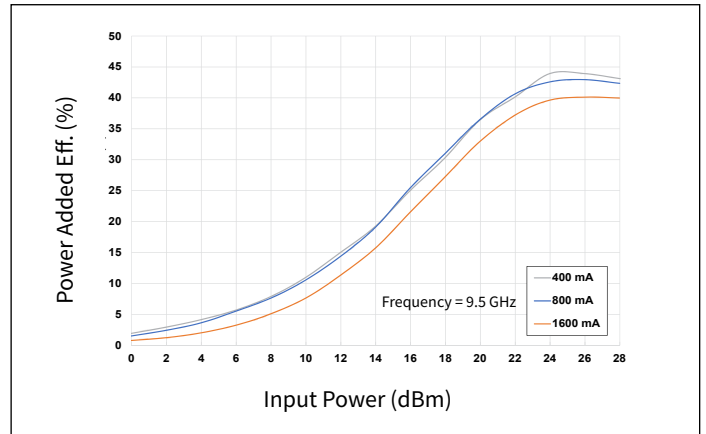

Figure 24. Power Added Eff. vs Input Power as a Function of I_{DQ}

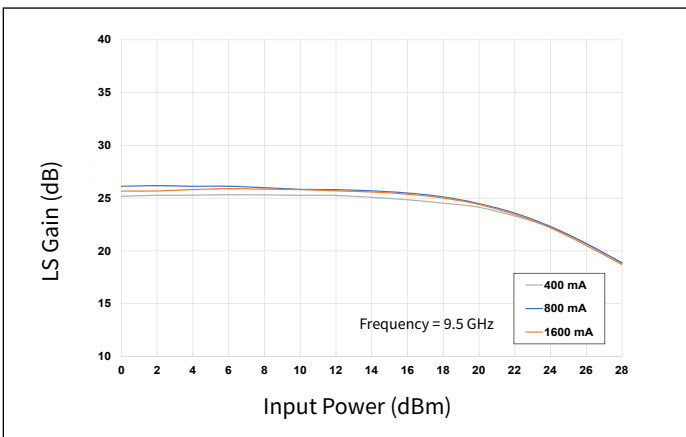

Figure 25. Large Signal Gain vs Input Power as a Function of I_{DQ}

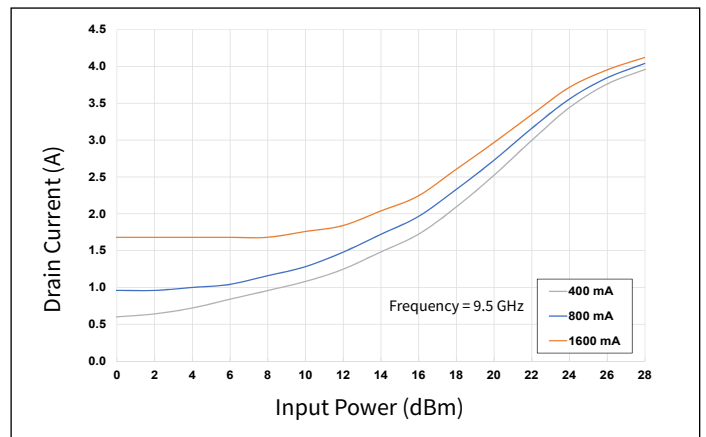

Figure 26. Drain Current vs Input Power as a Function of I_{DQ}

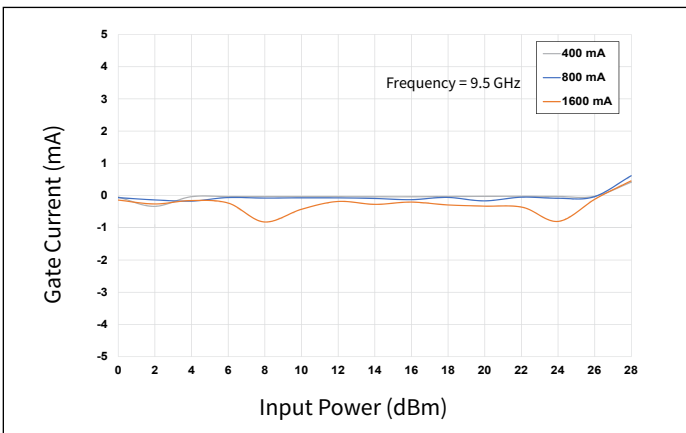

Figure 27. Gate Current vs Input Power as a Function of I_{DQ}



Typical Performance of the CMPA801B030S

Test conditions unless otherwise noted: $V_D = 28\text{ V}$, $I_{DQ} = 800\text{ mA}$, $PW = 100\mu\text{s}$, $DC = 10\%$, $P_{IN} = 26\text{ dBm}$, $T_{BASE} = +25^\circ\text{C}$

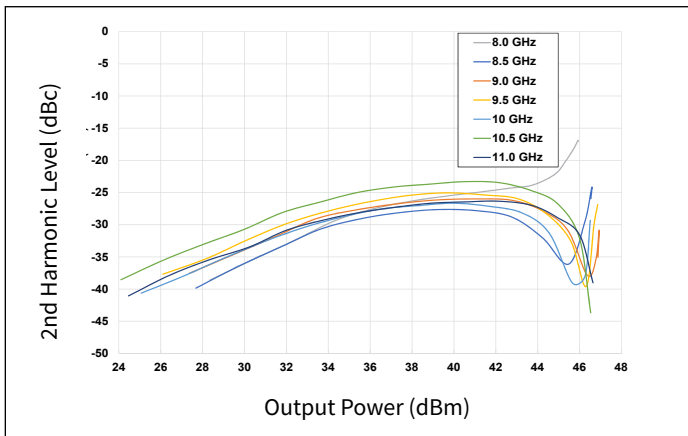

Figure 28. 2nd Harmonic vs Output Power as a Function of Frequency

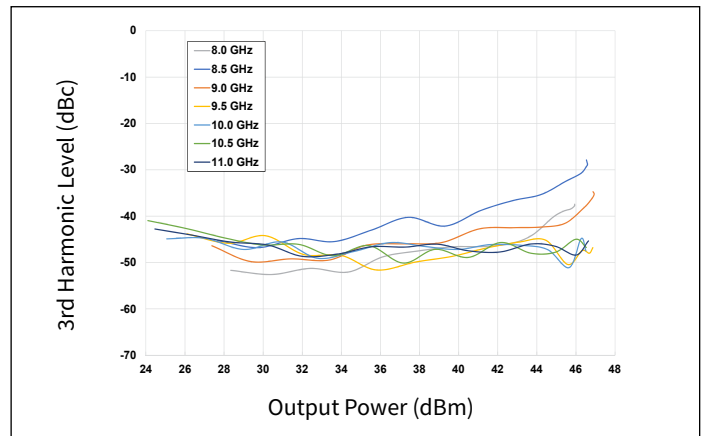

Figure 29. 3rd Harmonic vs Output Power as a Function of Frequency

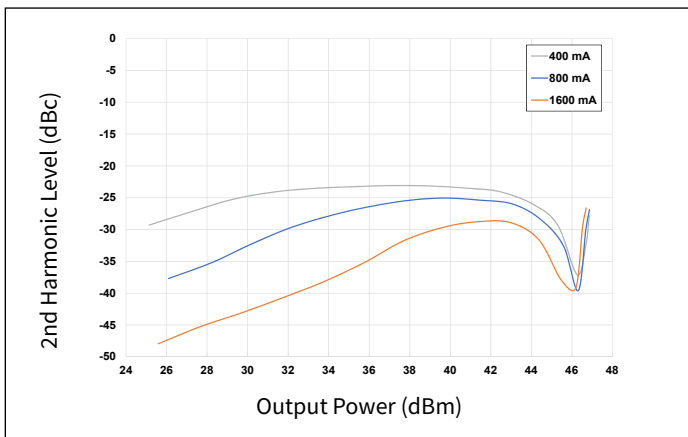

Figure 30. 2nd Harmonic vs Output Power as a Function of I_{DQ}

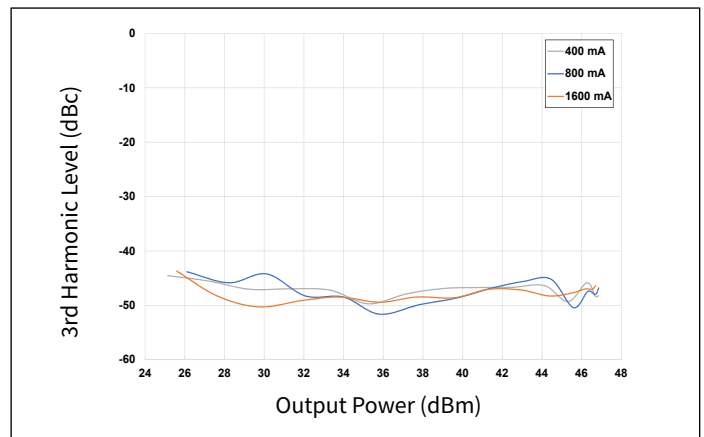

Figure 31. 3rd Harmonic vs Output Power as a Function of I_{DQ}



Typical Performance of the CMPA801B030S

Test conditions unless otherwise noted: $V_D = 28\text{ V}$, $I_{DQ} = 800\text{ mA}$, $P_{IN} = -20\text{ dBm}$, $T_{BASE} = +25^\circ\text{C}$

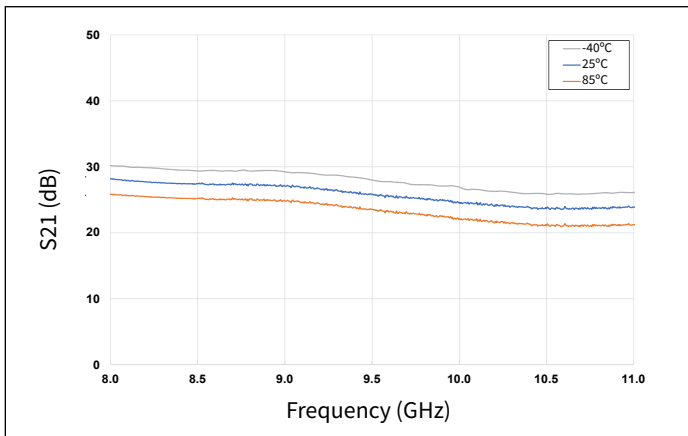

Figure 32. Gain vs Frequency as a Function of Temperature

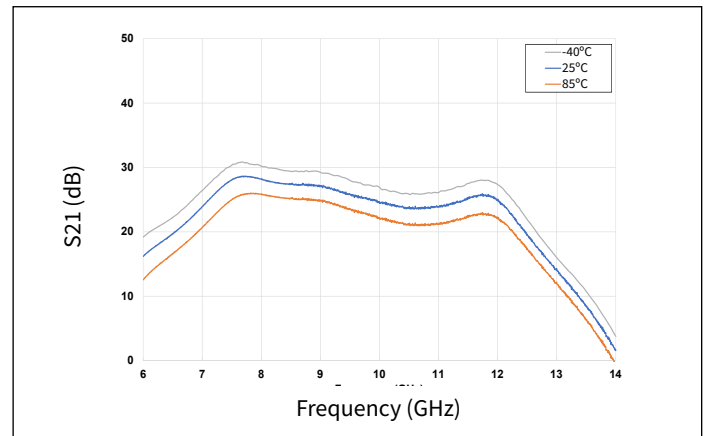

Figure 33. Gain vs Frequency as a Function of Temperature

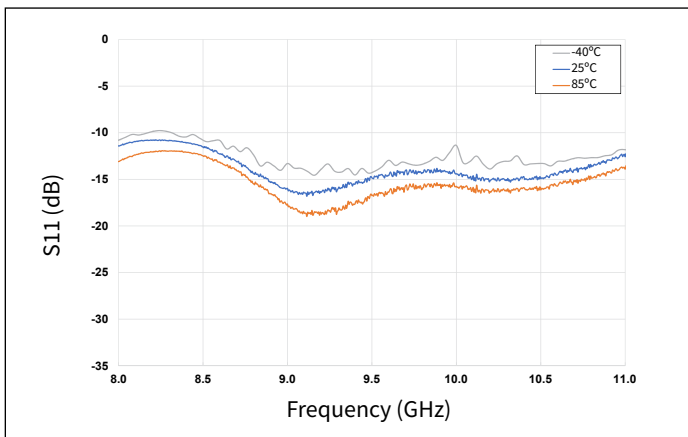

Figure 34. Input RL vs Frequency as a Function of Temperature

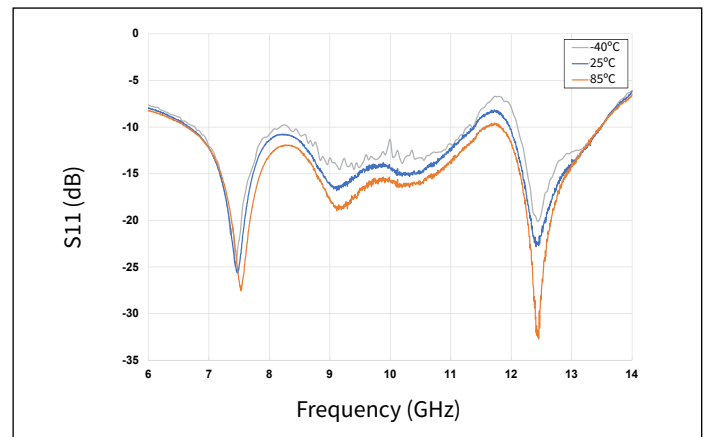

Figure 35. Input RL vs Frequency as a Function of Temperature

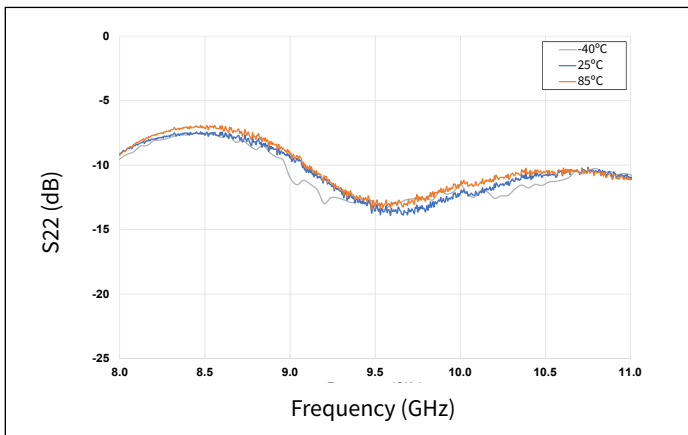

Figure 36. Output RL vs Frequency as a Function of Temperature

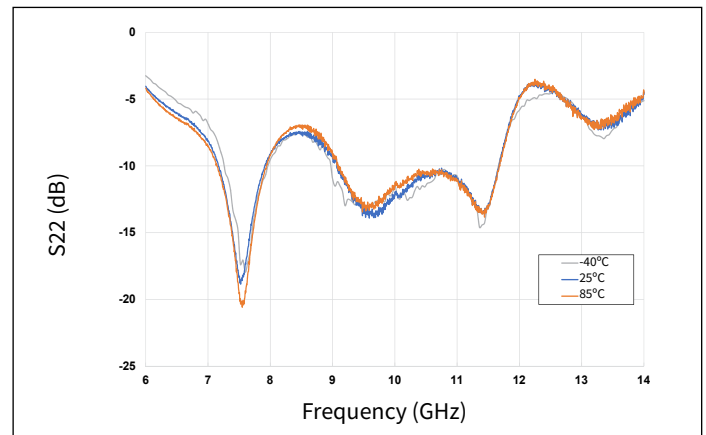

Figure 37. Output RL vs Frequency as a Function of Temperature

Typical Performance of the CMPA801B030S

Test conditions unless otherwise noted: $V_D = 28\text{ V}$, $I_{DQ} = 800\text{ mA}$, $P_{IN} = -20\text{ dBm}$, $T_{BASE} = +25^\circ\text{C}$

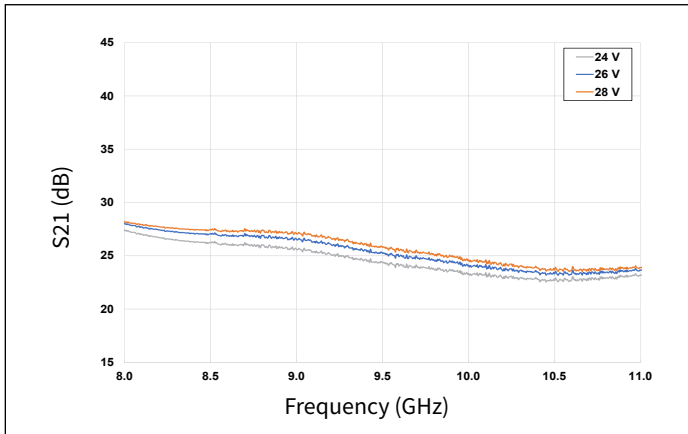

Figure 38. Gain vs Frequency as a Function of Voltage

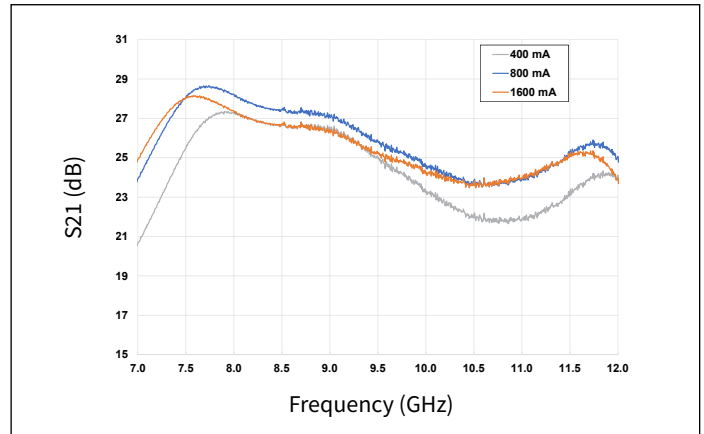

Figure 39. Gain vs Frequency as a Function of I_{DQ}

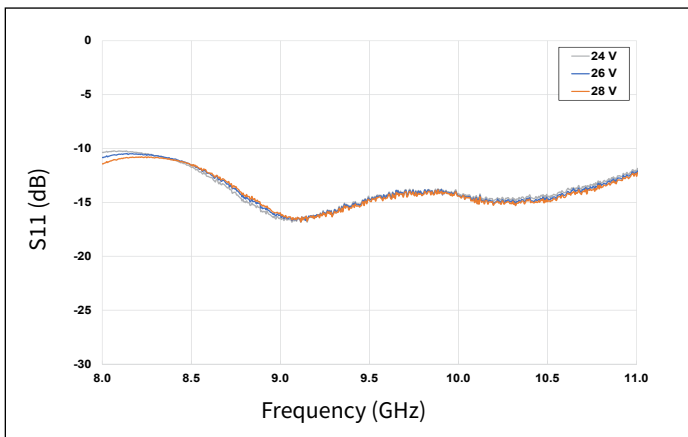

Figure 40. Input RL vs Frequency as a Function Voltage

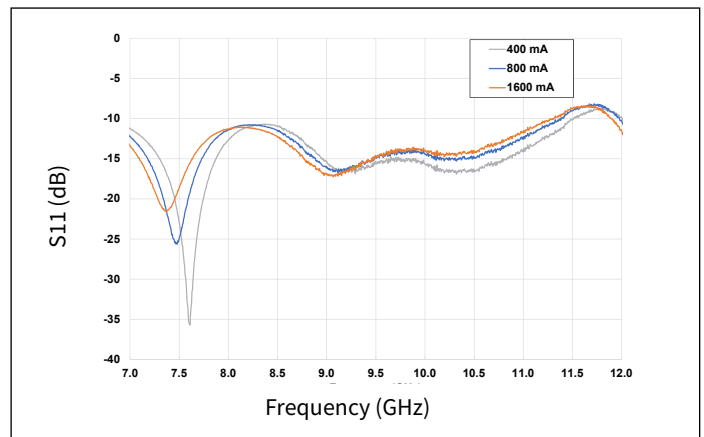

Figure 41. Input RL vs Frequency as a Function of I_{DQ}

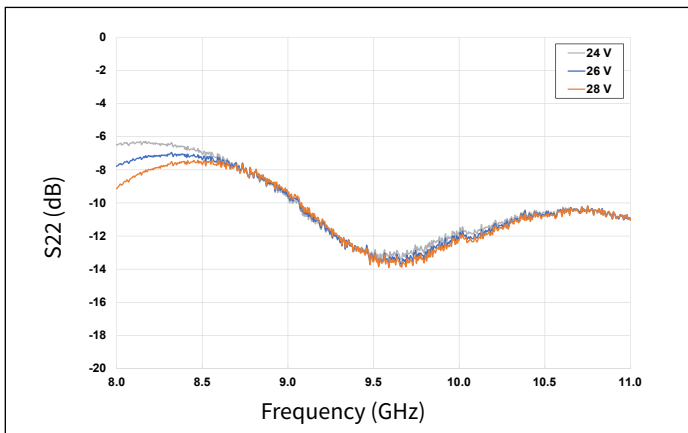

Figure 42. Output RL vs Frequency as a Function of Voltage

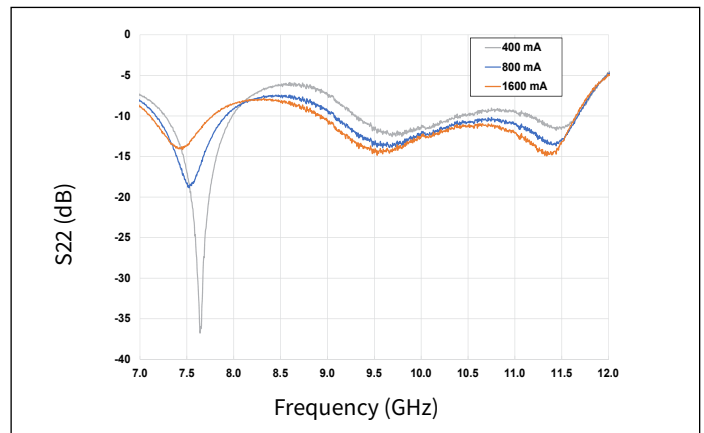
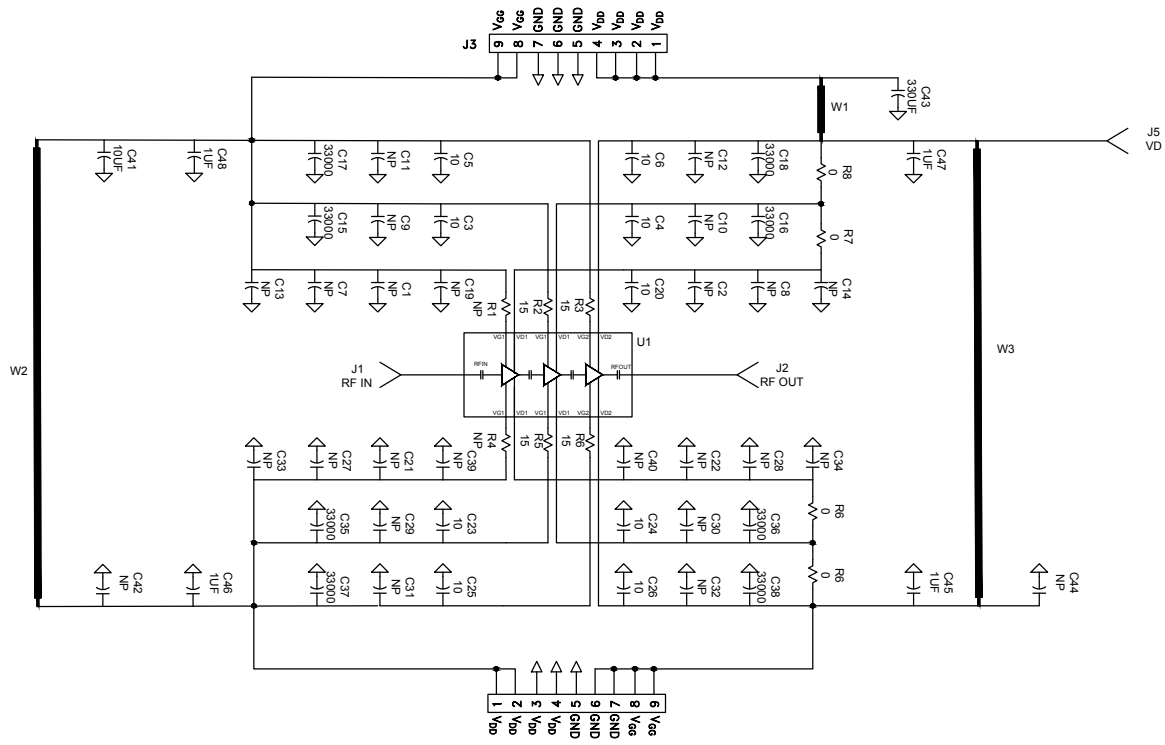

Figure 43. Output RL vs Frequency as a Function of I_{DQ}



CMPA801B030S-AMP1 Application Circuit



CMPA801B030S-AMP1 Evaluation Board Layout

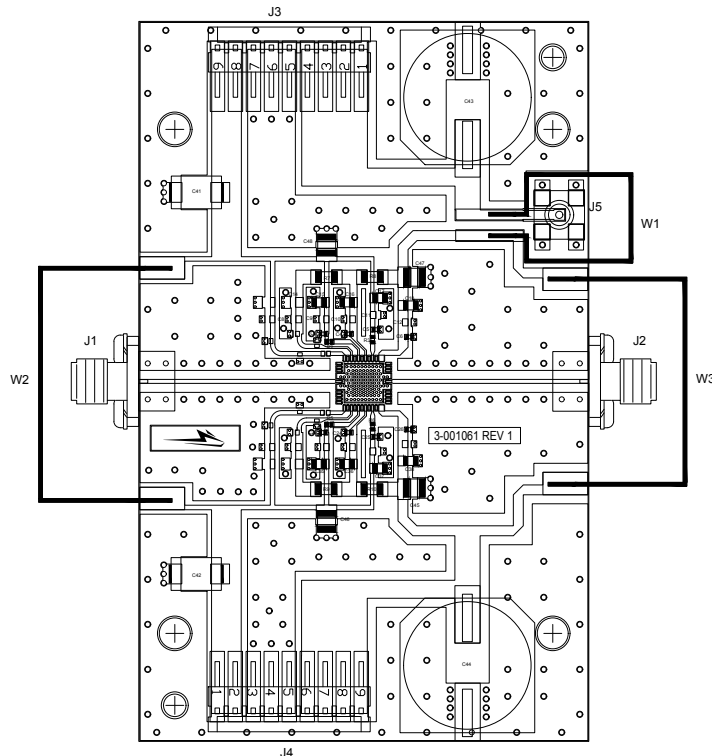



CMPA801B030S-AMP1 Evaluation Board Bill of Materials

Designator	Description	Qty
C3, C4, C5, C6, C23, C24, C25, C26	CAP, 10pF, +/-5%, pF, 200V, 0402	8
C15, C16, C17, C18, C35, C36, C37, C38	CA, 330000pF, 0805,100V, X7R	8
C45, C46, C47, C48	CAP, 1.0μF, 100V, 10%, X7R, 1210	4
C41	CAP 10μF 16V TANTALUM, 2312	1
C43	CAP, 330μF, +/-20%, 100V, ELECTROLYTIC, CASE SIZE K16	1
R2, R3, R5, R6	RES 15 OHM, +/-1%, 1/16W, 0402	6
R8, R10	RES 0.0 OHM 1/16W 1206 SMD	2
J1, J2	CONN, SMA, PANEL MOUNT JACK, FLANGE, 4-HOLE, BLUNT POST, 20MIL	4
J5	CONN, SMB, STRAIGHT JACK RECEPTACLE, SMT, 50 OHM, Au PLATED	1
J3, J4	HEADER RT>PLZ .1CEN LK 9POS	1
W2, W3	WIRE, BLACK, 20 AWG ~ 2.5"	2
W1	WIRE, BLACK, 20 AWG ~ 3.0"	1
	PCB, TEST FIXTURE, RF-35TC, 0.010 THK, 7X7 Overmold QFN SOCKET BOARD	1
	2-56 SOC HD SCREW 3/16 SS	4
	#2 SPLIT LOCKWASHER SS	4
Q1	CMPA801B030S	1

Electrostatic Discharge (ESD) Classifications

Parameter	Symbol	Class	Classification Level	Test Methodology
Human Body Model	HBM	1A	ANSI/ESDA/JEDEC JS-001 Table 3	JEDEC JESD22 A114-D
Charge Device Model	CDM	C2B	ANSI/ESDA/JEDEC JS-002 Table 3	JEDEC JESD22 C101-C

Moisture Sensitivity Level (MSL) Classification

Parameter	Symbol	Level	Test Methodology
Moisture Sensitivity Level	MSL	3 (168 hours)	IPC/JEDEC J-STD-20

Product Dimensions CMPA801B030S (Package Type — 7x7 QFN)

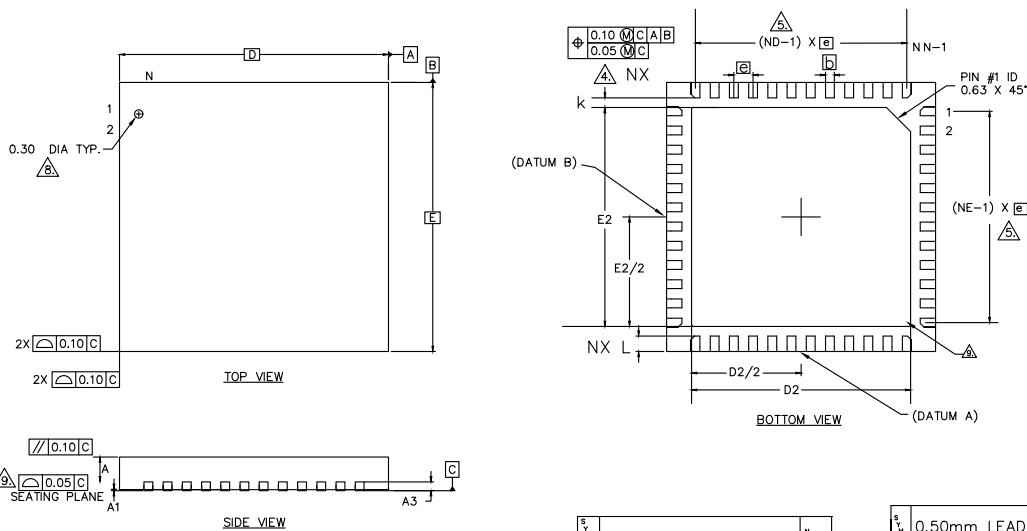

NOTES :

- DIMENSIONING AND TOLERANCING CONFORM TO ASME Y14.5M. – 1994.
- ALL DIMENSIONS ARE IN MILLIMETERS, 0 IS IN DEGREES.
- N IS THE TOTAL NUMBER OF TERMINALS.
- DIMENSION b APPLIES TO METALLIZED TERMINAL AND IS MEASURED BETWEEN 0.15 AND 0.30mm FROM TERMINAL TIP.
- ND AND NE REFER TO THE NUMBER OF TERMINALS ON EACH D AND E SIDE RESPECTIVELY.
- MAX. PACKAGE WARPAGE IS 0.05 mm.
- MAXIMUM ALLOWABLE BURRS IS 0.076 mm IN ALL DIRECTIONS.
- PIN #1 ID ON TOP WILL BE LASER MARKED.
- BILATERAL COPLANARITY ZONE APPLIES TO THE EXPOSED HEAT SINK SLUG AS WELL AS THE TERMINALS.
- THIS DRAWING CONFORMS TO JEDEC REGISTERED OUTLINE MQ-220
- ALL PLATED SURFACES ARE TIN 0.010 mm +/- 0.005mm.

Symbol	MIN.	NOM.	MAX.	n _D	n _E
A	0.80	0.9	1.0		
A1	0.00	0.03	0.06		
A3		0.20 REF			
C	0		12	2	
K		0.20 MIN.			
D		7.0 BSC			
E		7.0 BSC			

Symbol	MIN.	NOM.	MAX.	n _D	n _E
0.50mm LEAD PITCH					
b	0.50 BSC.				
N		48		3	
ND		12			
NE		12			
L	0.35	0.41	0.46		
b	0.19	0.25	0.33		
D2	5.61	5.72	5.83		
E2	5.61	5.72	5.83		

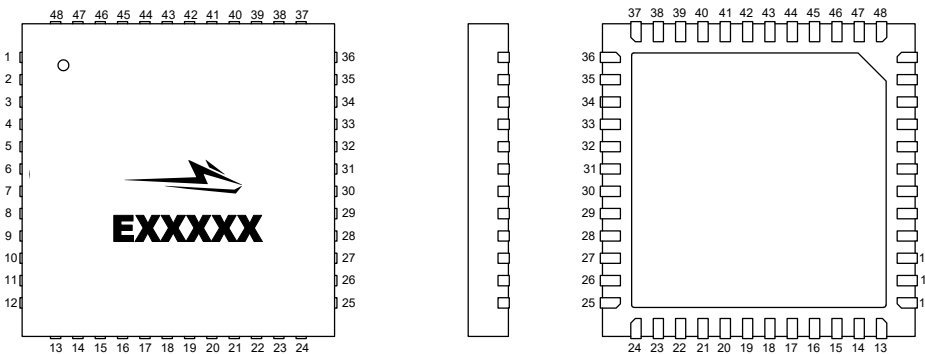

PIN	DESC.	PIN	DESC.	PIN	DESC.	PIN	DESC.
1	NC	15	NC	29	NC	43	NC
2	NC	16	NC	30	RFGND	44	VG1B
3	NC	17	VG1A	31	RFOUT	45	NC
4	NC	18	NC	32	RFGND	46	NC
5	RFGND	19	VD1A	33	NC	47	NC
6	RFIN	20	NC	34	NC	48	NC
7	RFGND	21	VG2A	35	NC		
8	NC	22	NC	36	NC		
9	NC	23	VD2A	37	NC		
10	NC	24	NC	38	VD2B		
11	NC	25	NC	39	NC		
12	NC	26	NC	40	VG2B		
13	NC	27	NC	41	NC		
14	NC	28	NC	42	VD1B		



Part Number System

CMPA801B030S

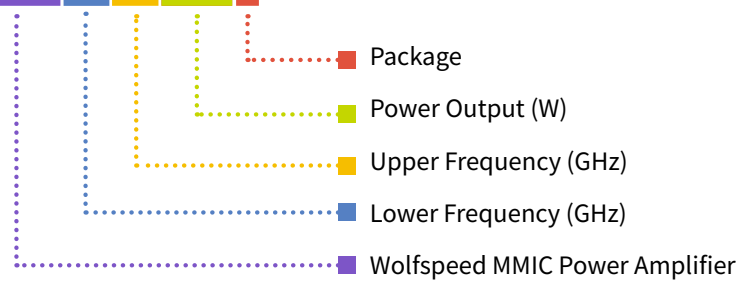

Table 1.

Parameter	Value	Units
Lower Frequency	7.9	GHz
Upper Frequency	11.0	
Power Output	40	W
Package	Surface Mount	–

Note:



¹ Alpha characters used in frequency code indicate a value greater than 9.9 GHz. See Table 2 for value.

Table 2.

Character Code	Code Value
A	0
B	1
C	2
D	3
E	4
F	5
G	6
H	7
J	8
K	9
Examples	1A = 10.0 GHz 2H = 27.0 GHz

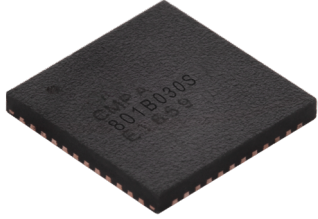

Product Ordering Information

Order Number	Description	Unit of Measure	Image
CMPA801B030S	Packaged GaN MMIC PA	Each	 A black, square, surface-mountable packaged GaN MMIC PA component. The top surface is marked with the part number 'CMPA801B030S' and the manufacturer's logo.
CMPA801B030S-AMP1	Evaluation Board with GaN MMIC Installed	Each	 A blue printed circuit board (PCB) evaluation board. It features a central GaN MMIC component, various surface components, a silver cylindrical component, and several connectors including SMA and USB.

**For more information, please contact:**

4600 Silicon Drive
Durham, NC 27703 USA
Tel: +1.919.313.5300
www.wolfspeed.com/RF

Sales Contact
RFSales@wolfspeed.com

RF Product Marketing Contact
RFMarketing@wolfspeed.com

Notes & Disclaimer

Specifications are subject to change without notice. “Typical” parameters are the average values expected by Wolfspeed in large quantities and are provided for information purposes only. Wolfspeed products are not warranted or authorized for use as critical components in medical, life-saving, or life-sustaining applications, or other applications where a failure would reasonably be expected to cause severe personal injury or death. No responsibility is assumed by Wolfspeed for any infringement of patents or other rights of third parties which may result from use of the information contained herein. No license is granted by implication or otherwise under any patent or patent rights of Wolfspeed.

©2021-2022 Wolfspeed, Inc. All rights reserved. Wolfspeed® and the Wolfstreak logo are registered trademarks and the Wolfspeed logo is a trademark of Wolfspeed, Inc.
PATENT: <https://www.wolfspeed.com/legal/patents>

The information in this document is subject to change without notice.