

NGB18N40ACLB - 18 A, 400 V, N-Channel Ignition IGBT, D²PAK

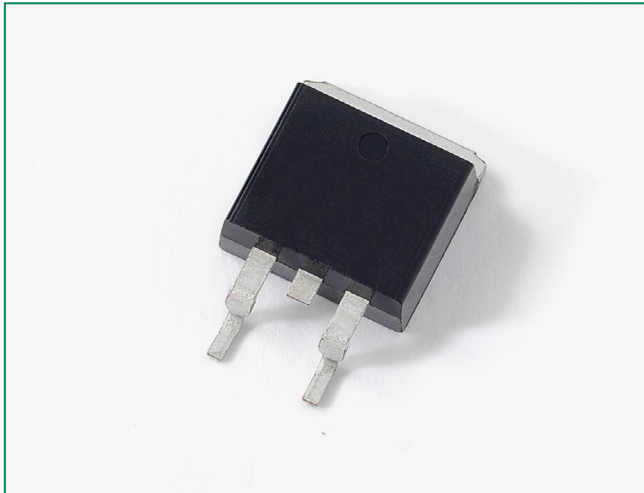

18 Amps, 400 Volts
 $V_{CE(on)} \leq 2.0 \text{ V @}$
 $I_C = 10 \text{ A, } V_{GE} \geq 4.5 \text{ V}$

Maximum Ratings (T_J = 25°C unless otherwise noted)

Rating	Symbol	Value	Unit
Collector–Emitter Voltage	V _{CES}	430	V _{DC}
Collector–Gate Voltage	V _{CER}	430	V _{DC}
Gate–Emitter Voltage	V _{GE}	18	V _{DC}
Collector Current–Continuous @ TC = 25°C – Pulsed	I _C	18 50	A _{DC} A _{AC}
ESD (Human Body Model) R = 1500 Ω, C = 100 pF	ESD	8.0	kV
ESD (Machine Model) R = 0 Ω, C = 200 pF	ESD	800	V
Total Power Dissipation @ TC = 25°C Derate above 25°C	PD	115 0.77	Watts W/°C
Operating and Storage Temperature Range	T _J , T _{stg}	-55 to +175	°C

Stresses exceeding those listed in the Maximum Ratings table may damage the device. If any of these limits are exceeded, device functionality should not be assumed, damage may occur and reliability may be affected.

Description

This Logic Level Insulated Gate Bipolar Transistor (IGBT) features monolithic circuitry integrating ESD and Over-Voltage clamped protection for use in inductive coil drivers applications. Primary uses include Ignition, Direct Fuel Injection, or wherever high voltage and high current switching is required.

Features

- Ideal for Coil-on-Plug Applications
- DPAK Package Offers Smaller Footprint for Increased Board Space
- Gate–Emitter ESD Protection
- Temperature Compensated Gate–Collector Voltage Clamp Limits Stress Applied to Load
- Integrated ESD Diode Protection
- New Design Increases Unclamped Inductive Switching (UIS) Energy Per Area
- Low Threshold Voltage Interfaces Power Loads to Logic or Microprocessor Devices
- Low Saturation Voltage
- High Pulsed Current Capability
- Optional Gate Resistor (R_G) and Gate–Emitter Resistor (R_{GE})
- Emitter Ballasting for Short–Circuit Capability
- These are Pb–Free Devices

Functional Diagram

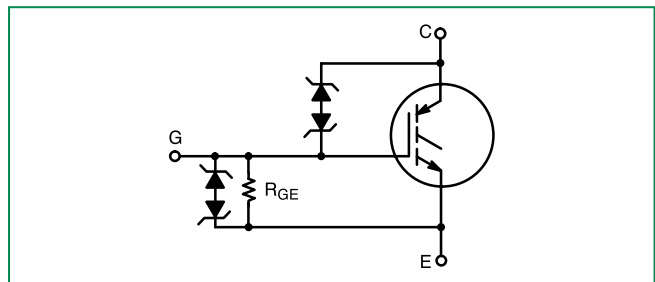

Additional Information



Datasheet



Resources



Samples

Unclamped Collector–To–Emitter Avalanche Characteristics ($-55^{\circ} \leq T_J \leq 150^{\circ} \text{C}$)

Rating	Symbol	Value	Unit
Single Pulse Collector–to–Emitter Avalanche Energy			
$V_{CC} = 50 \text{ V}, V_{GE} = 5.0 \text{ V}, P_k I_L = 21.1 \text{ A}, L = 1.8 \text{ mH}, \text{ Starting } T_J = 25^{\circ} \text{C}$	E_{AS}	400	mJ
$V_{CC} = 50 \text{ V}, V_{GE} = 5.0 \text{ V}, P_k I_L = 18.3 \text{ A}, L = 1.8 \text{ mH}, \text{ Starting } T_J = 125^{\circ} \text{C}$		300	
Reverse Avalanche Energy			
$V_{CC} = 100 \text{ V}, V_{GE} = 20 \text{ V}, P_k I_L = 25.8 \text{ A}, L = 6.0 \text{ mH}, \text{ Starting } T_J = 25^{\circ} \text{C}$	$E_{AS(R)}$	2000	mJ

Maximum Short-Circuit Times ($-55^{\circ} \leq T_J \leq 150^{\circ} \text{C}$)

Rating	Symbol	Value	Unit
Short Circuit Withstand Time 1 (See Figure 17, 3 Pulses with 10 ms Period)	t_{sc1}	750	μs
Short Circuit Withstand Time 2 (See Figure 18, 3 Pulses with 10 ms Period)	t_{sc2}	5.0	ms

Thermal Characteristics

Rating	Symbol	Value	Unit
Thermal Resistance, Junction to Case	$R_{\theta JC}$	1.3	$^{\circ}\text{C/W}$
Thermal Resistance, Junction to Ambient D ² PAK (Note 1)	$R_{\theta JA}$	50	$^{\circ}\text{C/W}$
Maximum Lead Temperature for Soldering Purposes, 1/8" from case for 5 seconds	T_L	275	$^{\circ}\text{C}$

Electrical Characteristics - OFF

Characteristic	Symbol	Test Conditions	Temperature	Min	Typ	Max	Unit
Collector–Emitter Clamp Voltage	BV_{CES}	$I_C = 2.0 \text{ mA}$	$T_J = -40^\circ\text{C}$ to 150°C	380	395	420	V_{DC}
		$I_C = 10 \text{ mA}$	$T_J = -40^\circ\text{C}$ to 150°C	390	405	430	
Zero Gate Voltage Collector Current	I_{CES}	$V_{CE} = 350$ $V_i, V_{GE} = 0 \text{ V}$	$T_J = 25^\circ\text{C}$	–	2.0	20	μA
			$T_J = 150^\circ\text{C}$	–	10	40*	
			$T_J = -40^\circ\text{C}$	–	1.0	10	
Reverse Collector–Emitter Leakage Current	I_{ECS}	$V_{CE} = -24 \text{ V}$	$T_J = 25^\circ\text{C}$	–	0.7	2.0	mA
			$T_J = 150^\circ\text{C}$	–	12	25*	
			$T_J = -40^\circ\text{C}$	–	0.1	1.0	
Reverse Collector–Emitter Clamp Voltage	$B_{V_{CES(R)}}$	$I_C = -75 \text{ mA}$	$T_J = 25^\circ\text{C}$	27	33	37	V_{DC}
			$T_J = 150^\circ\text{C}$	30	36	40	
			$T_J = -40^\circ\text{C}$	25	32	35	
Gate–Emitter Clamp Voltage	BV_{GES}	$I_G = 5.0 \text{ mA}$	$T_J = -40^\circ\text{C}$ to 150°C	11	13	15	V_{DC}
Gate–Emitter Leakage Current	I_{GES}	$V_{GE} = 10 \text{ V}$	$T_J = -40^\circ\text{C}$ to 150°C	384	640	1000	μA_{DC}
Gate Emitter Resistor	R_{GE}	–	$T_J = -40^\circ\text{C}$ to 150°C	10	16	26	$\text{k}\Omega$

Electrical Characteristics - ON (Note 2)

Characteristic	Symbol	Test Conditions	Temperature	Min	Typ	Max	Unit
Collector-to-Emitter On-Voltage	$V_{CE(on)}$	$I_C = 6.0 A,$ $V_{GE} = 4.0 V$	$T_J = 25^\circ C$	1.0	1.4	1.6	V_{DC}
			$T_J = 150^\circ C$	0.9	1.3	1.6	
			$T_J = -40^\circ C$	1.1	1.45	1.7*	
		$I_C = 8.0 A,$ $V_{GE} = 4.0 V$	$T_J = 25^\circ C$	1.3	1.6	1.9*	
			$T_J = 150^\circ C$	1.2	1.55	1.8	
			$T_J = -40^\circ C$	1.4	1.6	1.9*	
		$I_C = 10 A,$ $V_{GE} = 4.0 V$	$T_J = 25^\circ C$	1.4	1.8	2.05	
			$T_J = 150^\circ C$	1.5	1.8	2.0	
			$T_J = -40^\circ C$	1.4	1.8	2.1*	
		$I_C = 15 A,$ $V_{GE} = 4.0 V$	$T_J = 25^\circ C$	1.6	1.9	2.2	
			$T_J = 150^\circ C$	1.7	2.1	2.3	
			$T_J = -40^\circ C$	1.6	1.8	2.2	
		$I_C = 10 A,$ $V_{GE} = 4.5 V$	$T_J = 25^\circ C$	1.3	1.8	2.0*	
$T_J = 150^\circ C$	1.3		1.75	2.0*			
$T_J = -40^\circ C$	1.4		1.8	2.0*			
$I_C = 6.5 A,$ $V_{GE} = 3.7 V$	$T_J = 25^\circ C$	-	-	1.65			
Forward Transconductance	gfs	$V_{CE} = 5.0 V,$ $I_C = 6.0 A$	$T_J = -40^\circ C$ to $150^\circ C$	8.0	14	25	Mhos

Dynamic Characteristics

Characteristic	Symbol	Test Conditions	Temperature	Min	Typ	Max	Unit
Input Capacitance	C_{ISS}	$V_{CC} = 25 V,$ $V_{GE} = 0 V$ $f = 1.0 MHz$	$T_J = -40^\circ C$ to $150^\circ C$	400	800	1000	pF
Output Capacitance	C_{OSS}			50	75	100	
Transfer Capacitance	C_{RSS}			4.0	7.0	10	

Switching Characteristics

Characteristic	Symbol	Test Conditions	Temperature	Min	Typ	Max	Unit
Turn-Off Delay Time (Resistive)	$t_{d(off)}$	$V_{CC} = 300\text{ V}$, $I_C = 6.5\text{ A}$ $R_G = 1.0\text{ k}\Omega$, $R_L = 46\ \Omega$,	$T_J = 25^\circ\text{C}$	-	4.0	10	μS
Fall Time (Resistive)	t_f	$V_{CC} = 300\text{ V}$, $I_C = 6.5\text{ A}$ $R_G = 1.0\text{ k}\Omega$, $R_L = 46\ \Omega$,	$T_J = 25^\circ\text{C}$	-	9.0	15	
Turn-On Delay Time	$t_{d(on)}$	$V_{CC} = 10\text{ V}$, $I_C = 6.5\text{ A}$ $R_G = 1.0\text{ k}\Omega$, $R_L = 1.5\ \Omega$,	$T_J = 25^\circ\text{C}$	-	0.7	4.0	μS
Rise Time	t_r	$V_{CC} = 10\text{ V}$, $I_C = 6.5\text{ A}$ $R_G = 1.0\text{ k}\Omega$, $R_L = 1.5\ \Omega$,	$T_J = 25^\circ\text{C}$	-	4.5	7.0	

*Maximum Value of Characteristic across Temperature Range.

1. When surface mounted to an FR4 board using the minimum recommended pad size.
2. Pulse Test: Pulse Width $\leq 300\ \mu\text{S}$, Duty Cycle $\leq 2\%$.

Ratings and Characteristic Curves

Figure 1. Output Characteristics

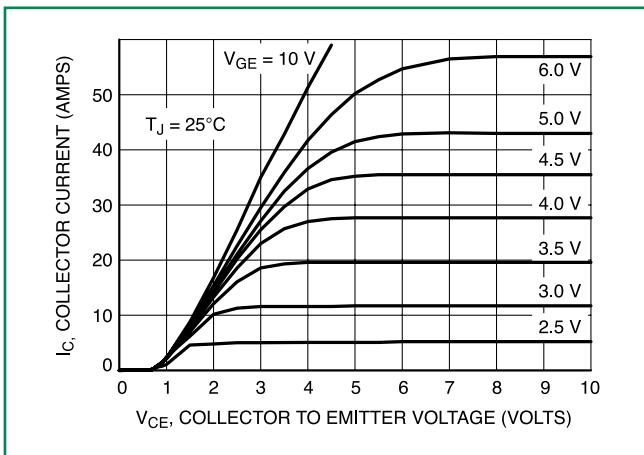

Figure 2. Output Characteristics

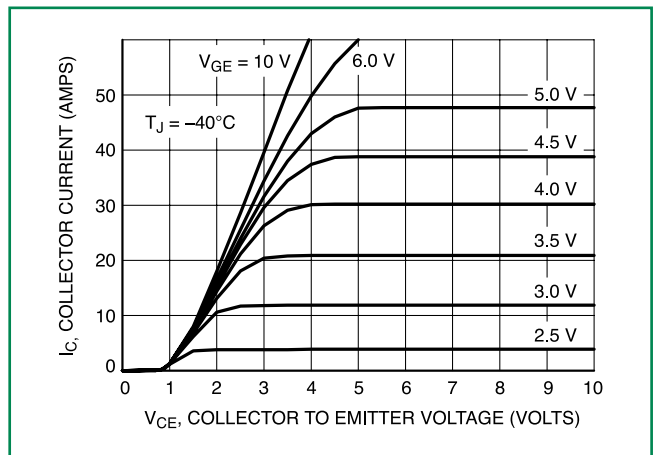

Figure 3. Output Characteristics

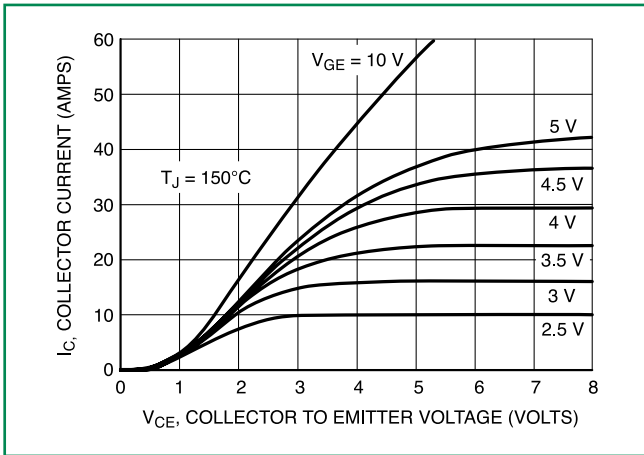

Figure 4. Transfer Characteristics

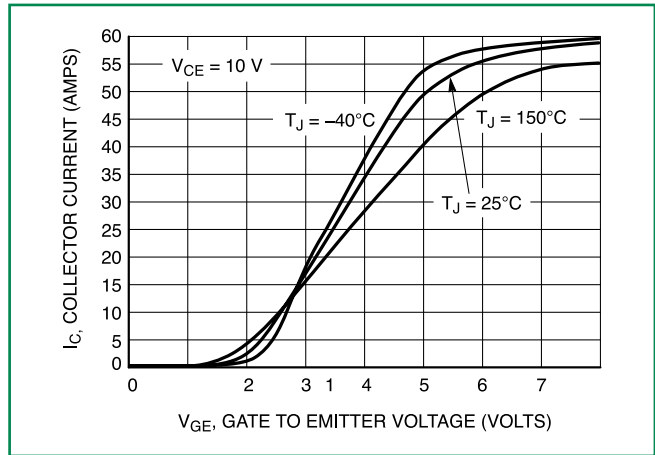

Figure 5. Collector-to-Emitter Saturation Voltage versus Junction Temperature

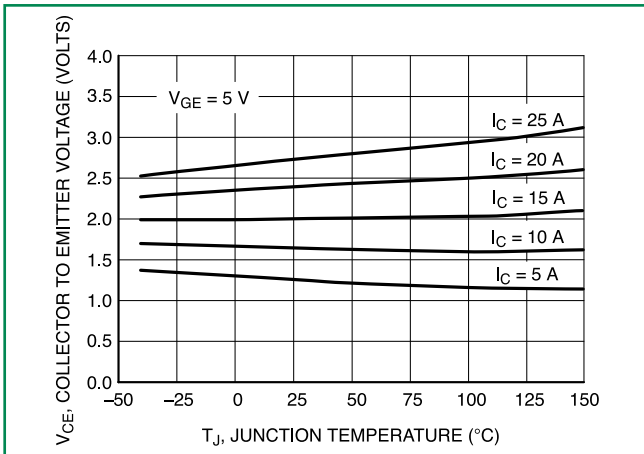

Figure 6. Collector-to-Emitter Voltage versus Gate-to-Emitter Voltage

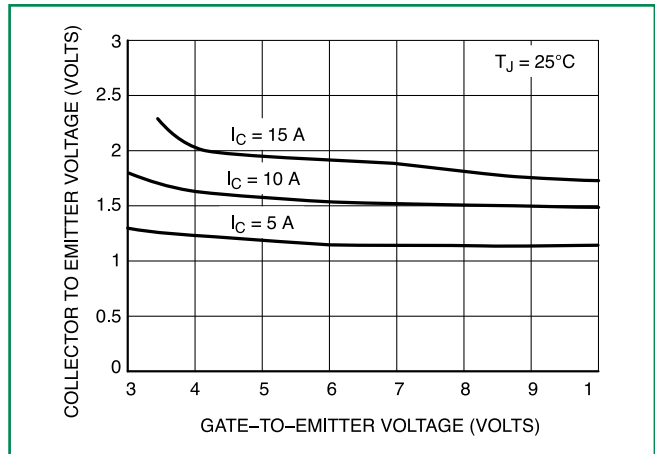

Figure 7. Collector-to-Emitter Voltage versus Gate-to-Emitter Voltage

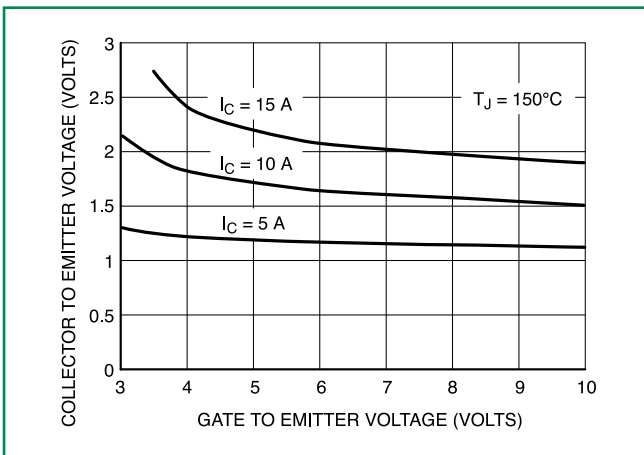

Figure 8. Capacitance Variation

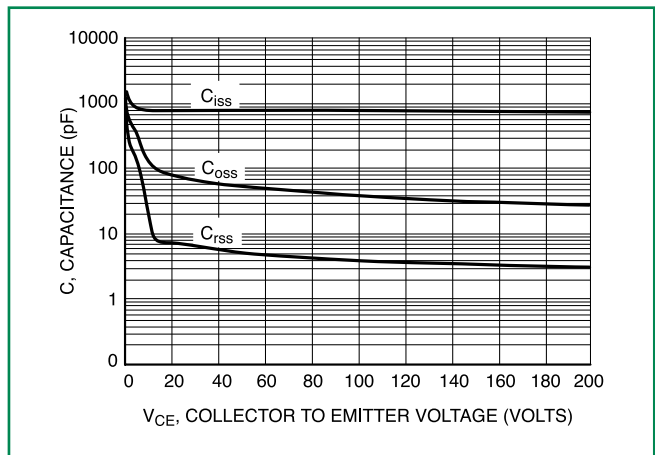

Figure 9. Gate Threshold Voltage versus Temperature

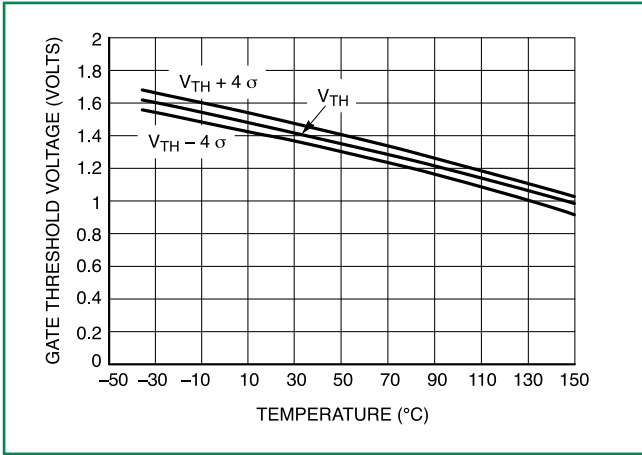

Figure 10. Minimum Open Secondary Latch Current versus Temperature

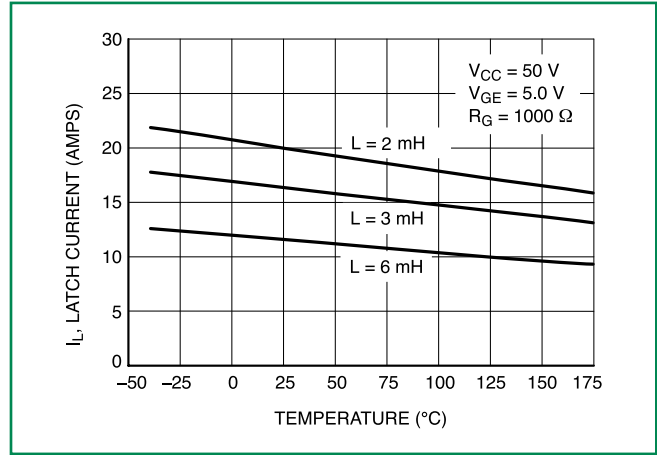

Figure 11. Typical Open Secondary Latch Current versus Temperature

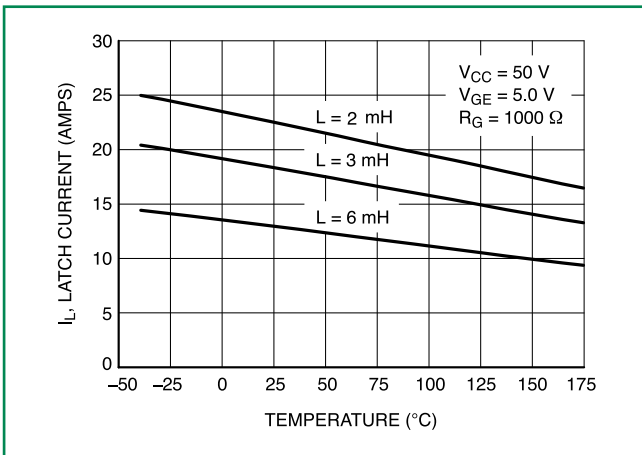

Figure 12. Inductive Switching Fall Time versus Temperature

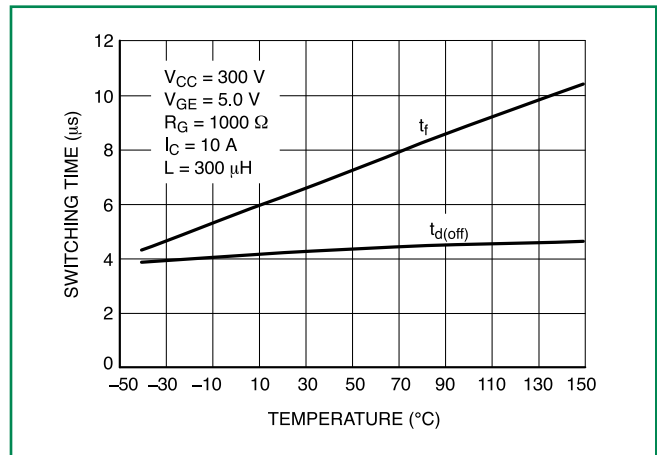

Figure 13. Single Pulse Safe Operating Area
(Mounted on an Infinite Heatsink at $T_A = 25^\circ\text{C}$)

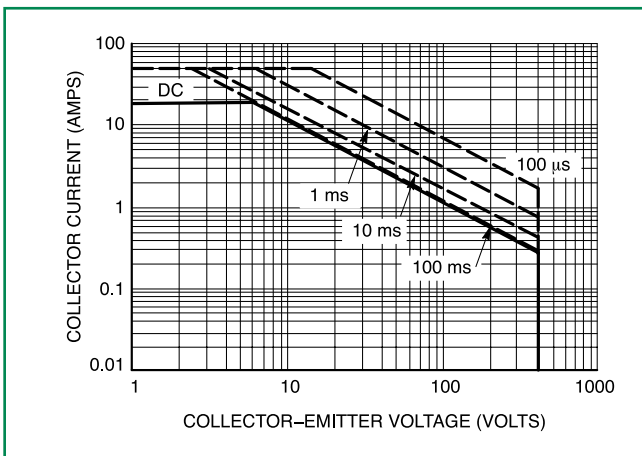

Figure 14. Single Pulse Safe Operating Area
(Mounted on an Infinite Heatsink at $T_A = 125^\circ\text{C}$)

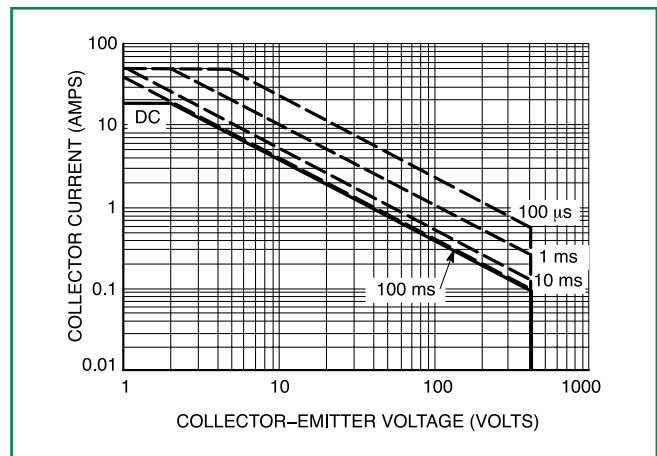

Figure 15. Pulse Train Safe Operating Area
 (Mounted on an Infinite Heatsink at $T_c = 25^\circ\text{C}$)

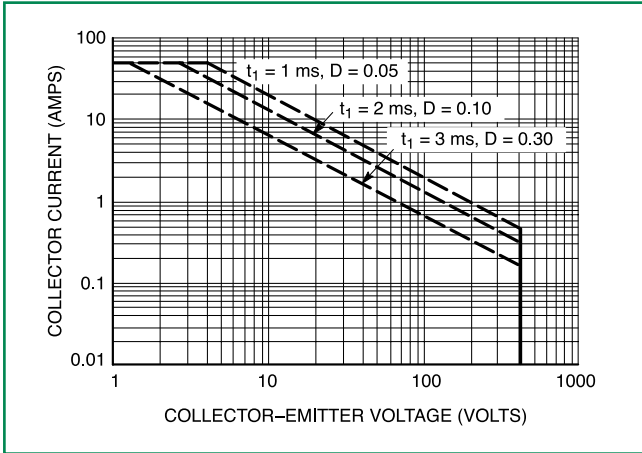

Figure 15. Pulse Train Safe Operating Area
 (Mounted on an Infinite Heatsink at $T_c = 125^\circ\text{C}$)

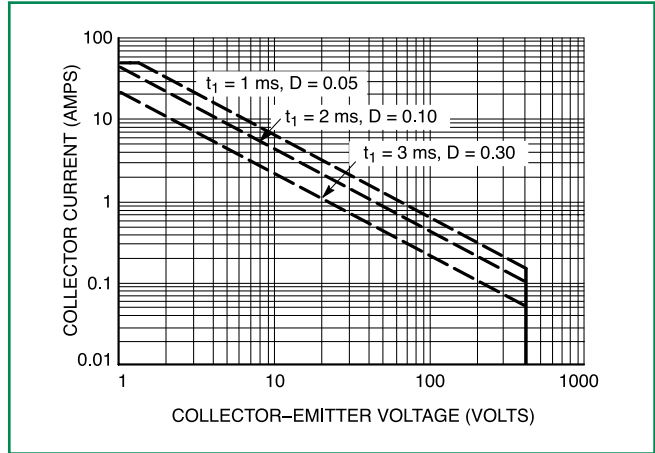

Figure 17. Circuit Configuration for Short Circuit Test #1

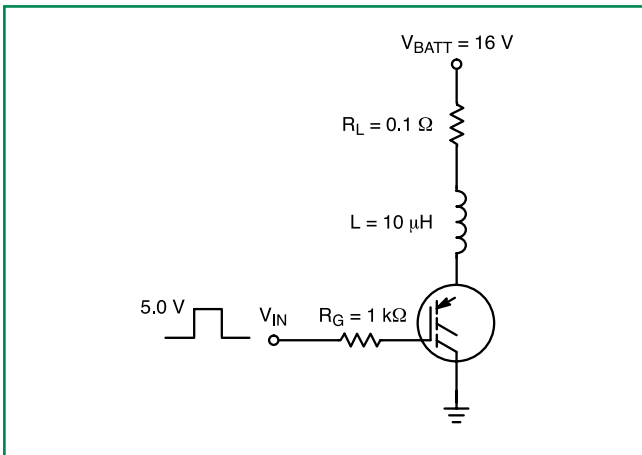

Figure 18. Circuit Configuration for Short Circuit Test #2

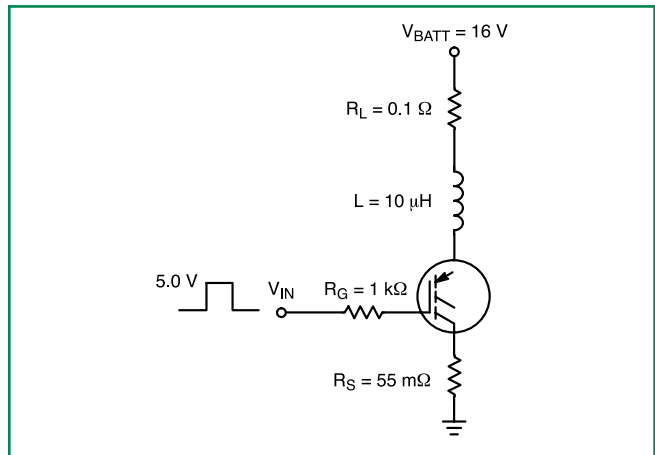
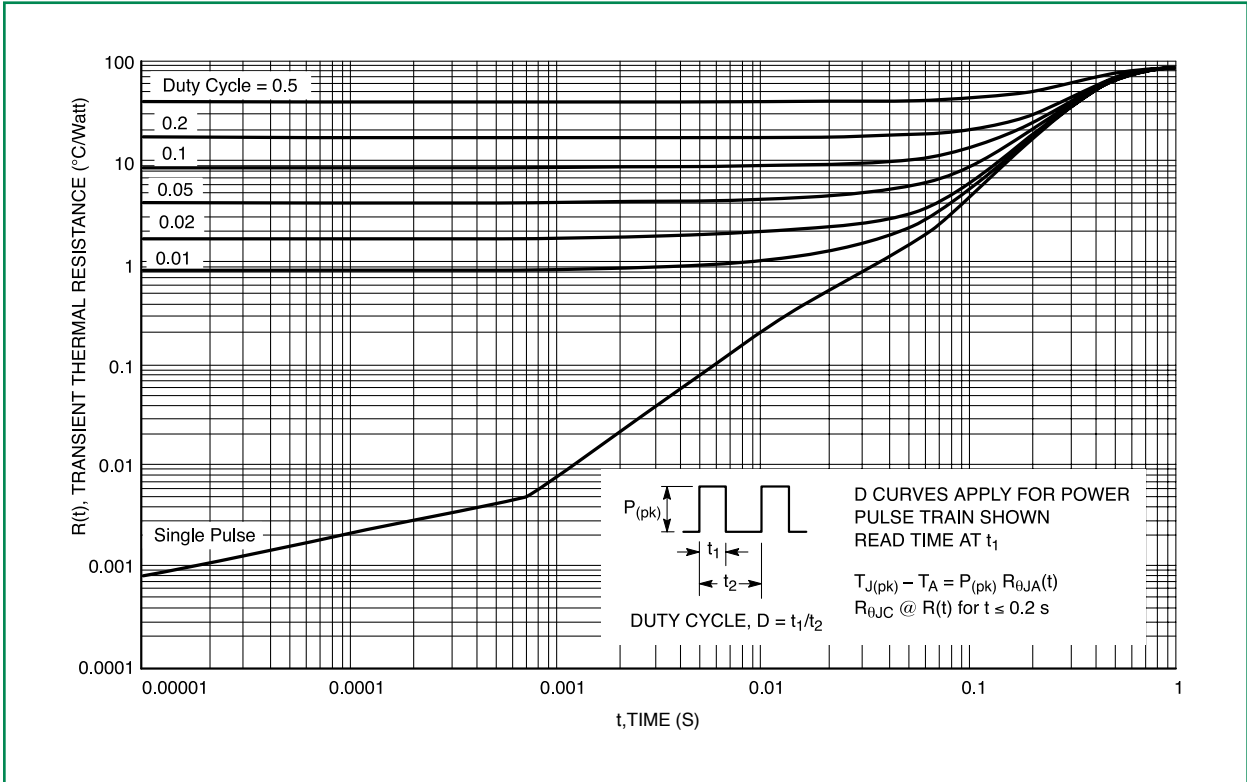
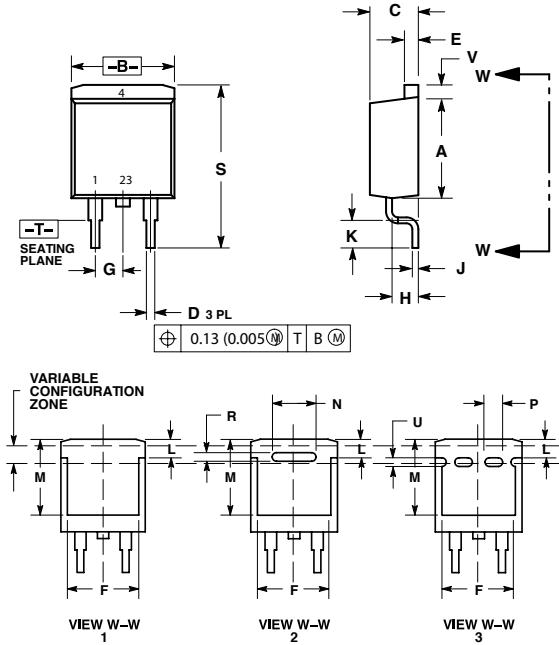

Figure 19. Transient Thermal Resistance (Non-normalized Junction-to-Ambient mounted on minimum pad area)



Dimensions



Dim	Inches		Millimeters	
	Min	Max	Min	Max
A	0.086	0.094	2.18	2.38
A1	0.000	0.005	0.00	0.13
b	0.025	0.035	0.63	0.89
b2	0.028	0.045	0.72	1.14
b3	0.180	0.215	4.57	5.46
c	0.018	0.024	0.46	0.61
c2	0.018	0.024	0.46	0.61
D	0.235	0.245	5.97	6.22
E	0.250	0.265	6.35	6.73
e	0.090 BSC		2.29 BSC	
H	0.370	0.410	9.40	10.41
L	0.055	0.070	1.40	1.78
L1	0.114 REF		2.90 REF	
L2	0.020 BSC		0.51 BSC	
L3	0.035	0.050	0.89	1.27
L4	---	0.040	---	1.01
Z	0.155	---	3.93	---

NOTES:

1. DIMENSIONING AND TOLERANCING PER ASMEY14.5M, 1994.
2. CONTROLLING DIMENSION: INCHES.
3. THERMAL PAD CONTOUR OPTIONAL WITHIN DIMENSIONS b3, L3 and Z.
4. DIMENSIONS D AND E DO NOT INCLUDE MOLD FLASH, PROTRUSIONS, OR BURRS. MOLD FLASH, PROTRUSIONS, OR GATE BURRS SHALL NOT EXCEED 0.006 INCHES PER SIDE.
5. DIMENSIONS D AND E ARE DETERMINED AT THE OUTERMOST EXTREMES OF THE PLASTIC BODY.
6. DATUMS A AND B ARE DETERMINED AT DATUM PLANE H.
7. OPTIONAL MOLD FEATURE.

Soldering Footprint

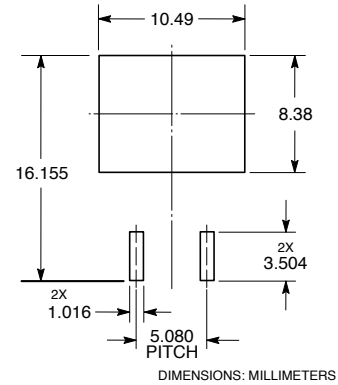

Part Marking System

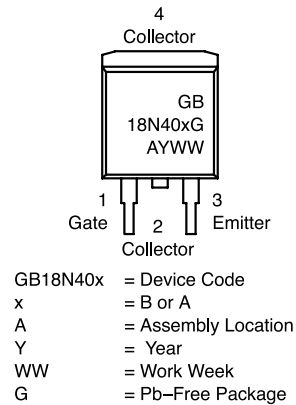

ORDERING INFORMATION

Device	Package	Shipping†
NGB18N40ACLB4G	DPAK (Pb-Free)	2500 / Tape & Reel

Disclaimer Notice - Information furnished is believed to be accurate and reliable. However, users should independently evaluate the suitability of and test each product selected for their own applications. Littelfuse products are not designed for, and may not be used in, all applications. Read complete Disclaimer Notice at: www.littelfuse.com/disclaimer-electronics.