

Peak Emission Wavelength: 660nm

The 660nm reflective sensor consists of a 660nm visible emitter and high sensitivity photo diode in the same package. The black molded housing reduces the effect of external ambient light. Custom emitter/detectors are available.

FEATURES

- > High Reliability
- > 5.1 x 3.3mm Surface Mount Package
- > Short Detection Distance Optimum 0.5-1.5mm

APPLICATIONS

- > Card Reader
- > Bar-code Reader
- > Edge Sensing / Money-bill Reader

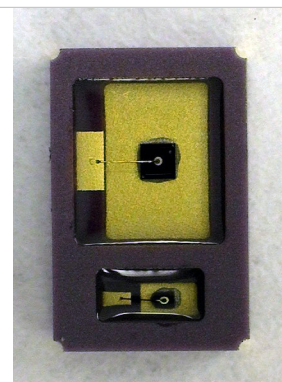

Absolute Maximum Ratings (Ta=25°C)



ITEMS	SYMBOL	RATINGS	UNIT
Forward Current (LED)	IF	40	mA
Pulse Forward Current (LED)*1	IFP	0.5	A
Reverse Voltage (LED)	VR	5	V
Power Dissipation (LED)	PD	100	mW
Operating Temperature Range	Topr	-20 to +80	°C
Storage Temperature Range	Tstg	-30 to +100	°C

*1: Tw=10µsec, T=10msec.

Electrical & Optical Characteristics (Ta = 25°C)

ITEMS	SYMBOL	CONDITIONS	MIN	TYP	MAX	UNIT
Forward Voltage (LED)	VF	IF=20mA	--	1.8	--	V
Forward Voltage (PD)	VF	IF=20mA	--	--	1.3	V
Peak Emissions Wavelength	λ_p	IF=20mA	640	660	670	nm
Spectral Line Half Width	$\Delta\lambda$	IF=20mA	--	25	--	nm
Power Output	PO	IF=20mA	--	0.8	--	mW
Reverse Dark Current (Iceo)	ID	VR=10V H=0mw/cm2	--	--	10	nA
Reverse Light Current	IL	VR=5V CT=2870°K H=5mw/cm2	1.8	2.0	2.2	uA
Reverse Breakdown Voltage	V(BR)R	IR=100uA H=0mw/cm2	33	--	--	V
Open Circuit Voltage	VOC	CT=2870°K H=5mw/cm2	--	420	--	mV
Short Circuit Current	SC	CT=2870°K H=5mw/cm2	--	1.5	--	µA
Total Capacitance	CT	VR=5V H=0mw/cm2 f=1MHz	--	5	--	pF

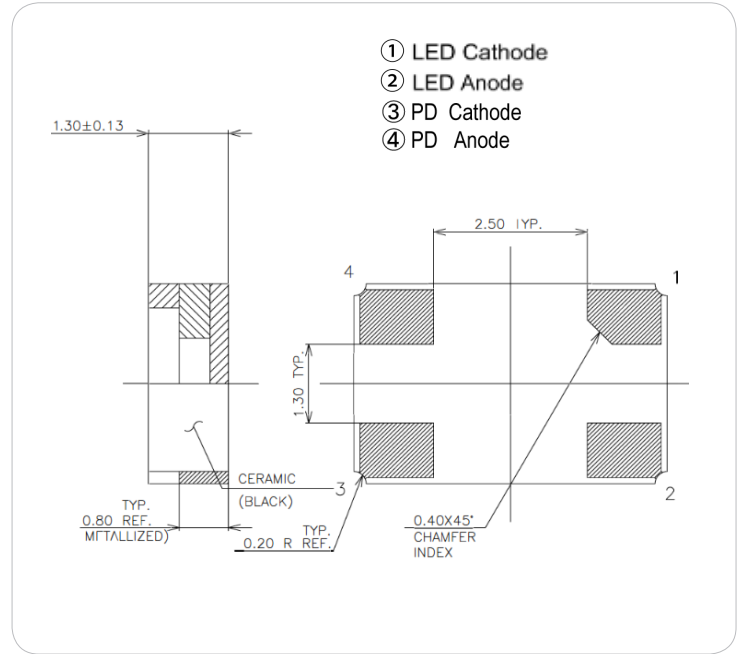
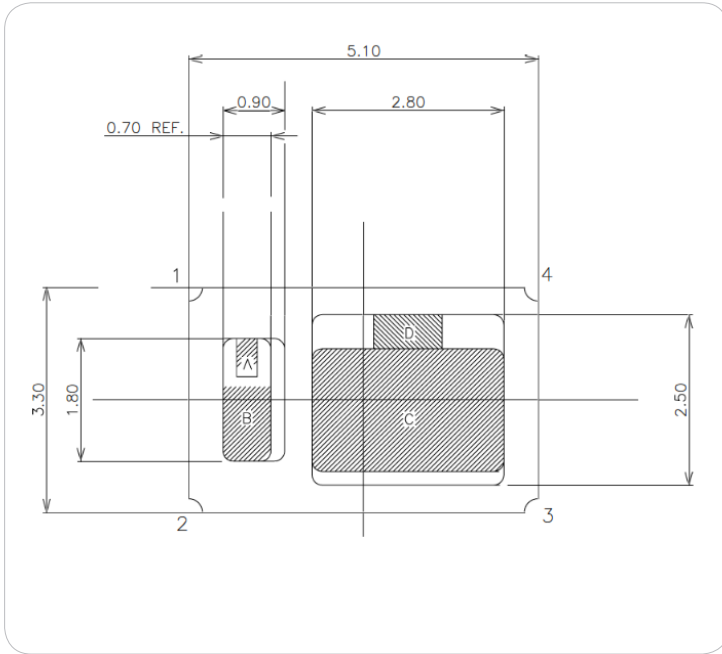

EMITTER SPECTRAL RESPONSE

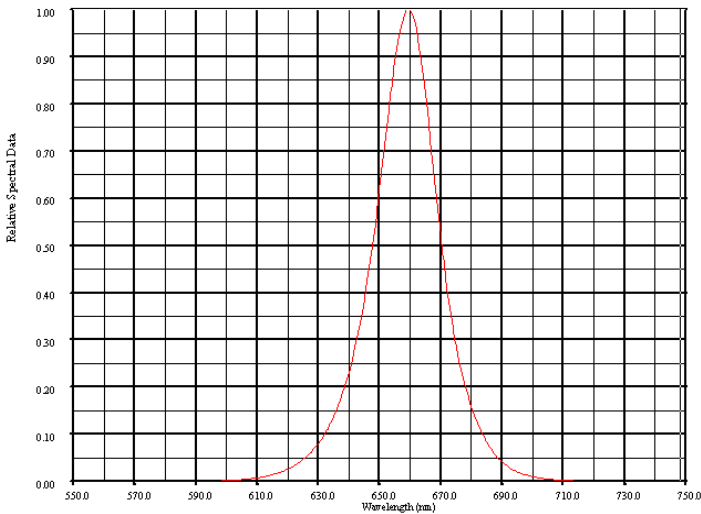

FORWARD I-V CHARACTERISTICS

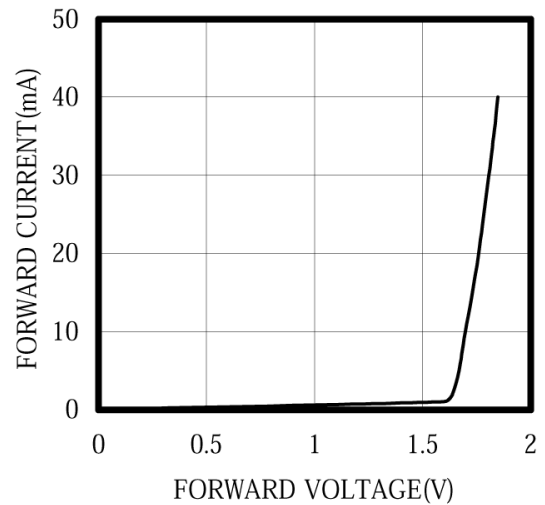

Unit: mm, Tolerance: ±0.2

2019-04-22

THERMAL DERATING CURVE

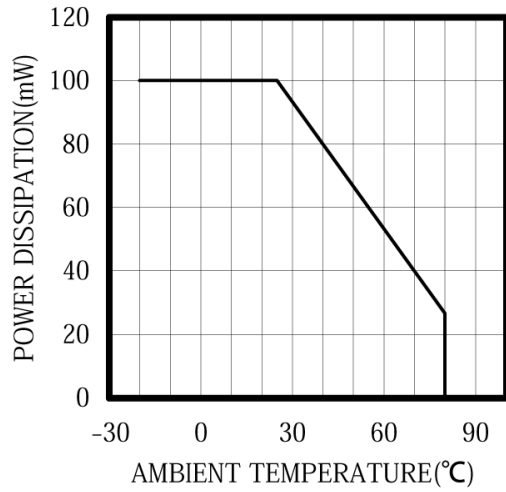

CAPACITANCE vs REVERSE VOLTAGE

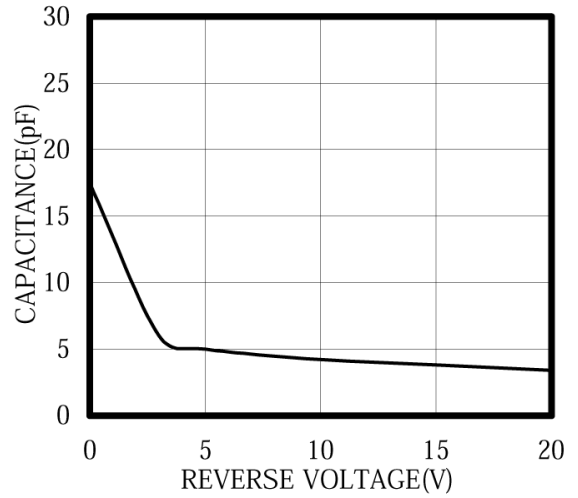

IF VS I_o @VR=10V

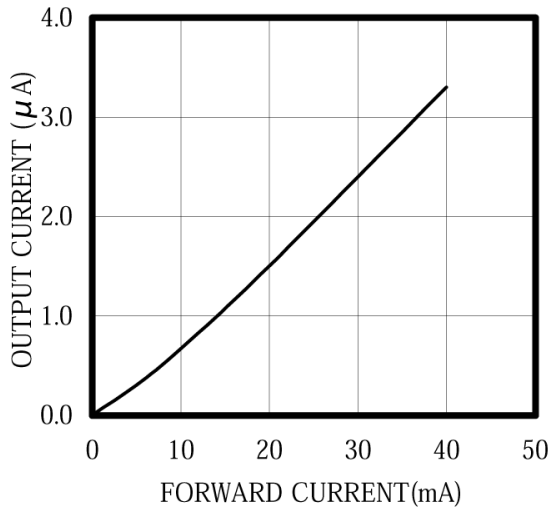

RELATIVE OUTPUT vs DISTANCE

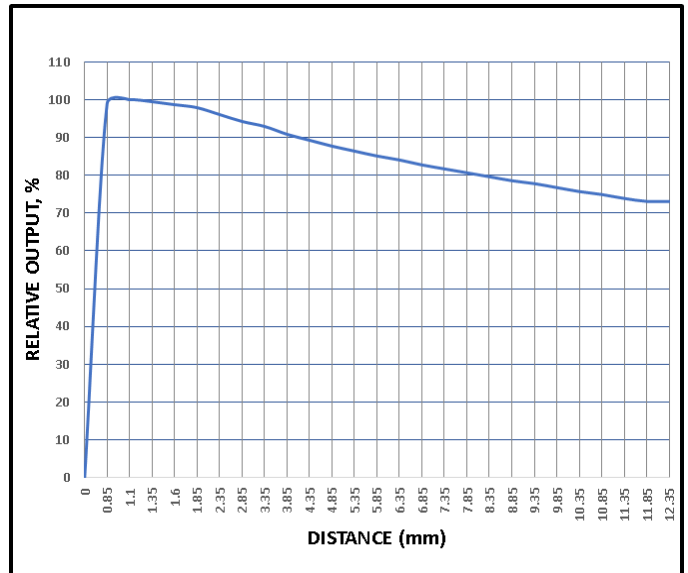

RESPONSIVITY

