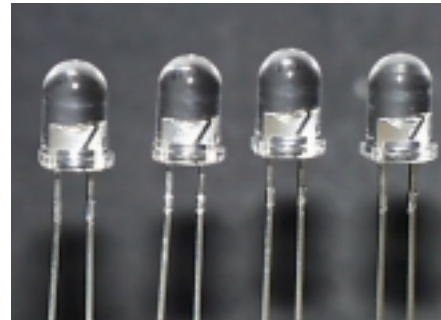

Technical Data**Ultra Bright LED Lamp for Traffic Sign**

LTL2P3SEK	Red (22°)
LTL2R3SEK	Red (30°)
LTL2P3SYK	Amber (22°)
LTL2R3SYK	Amber (30°)

**Benefits**

- * Lower system cost.
- * Higher luminous efficiency than incandescent lamp.
- * Fewer LED are required due to the TS AlInGaP technology.

Features

- * High luminous intensity output.
- * Low power consumption.
- * High efficiency.
- * Versatile mounting on PCB or panel.
- * I.C. Compatible / low current requirements.
- * Popular T-1 $\frac{3}{4}$ diameter (5 mm).

Applications

- * Traffic signals.
- * Versatile warning signals.
- * Outdoor traffic display panels.

Description

The source color light emitting diode dice of these devices is made of AlInGaP on a transparent substrate (TS). The water clear epoxy lens on these devices create viewing angles of 22 and 30 degrees that match international specifications for traffic sign utilization. These LED lamps provide superior endurance against moisture and high temperatures thus are reliable for outdoor environment use. With a lower power consumption than traditional incandescent lamps, these devices yield lower system cost.

Selection Guide

Part No	Color	Iv(mcd)	V _a	λ _d (nm)
LTL2P3SEK	Red	4800	22°	630
LTL2R3SEK	Red	3700	30°	630
LTL2P3SYK	Amber	3700	22°	592
LTL2R3SYK	Amber	2800	30°	592

Features

- * High luminous intensity output.
- * Low power consumption.
- * High efficiency.
- * Versatile mounting on PCB or panel.
- * I.C. Compatible / low current requirements.
- * Popular T-1 ³/₄ diameter.

Package Dimensions

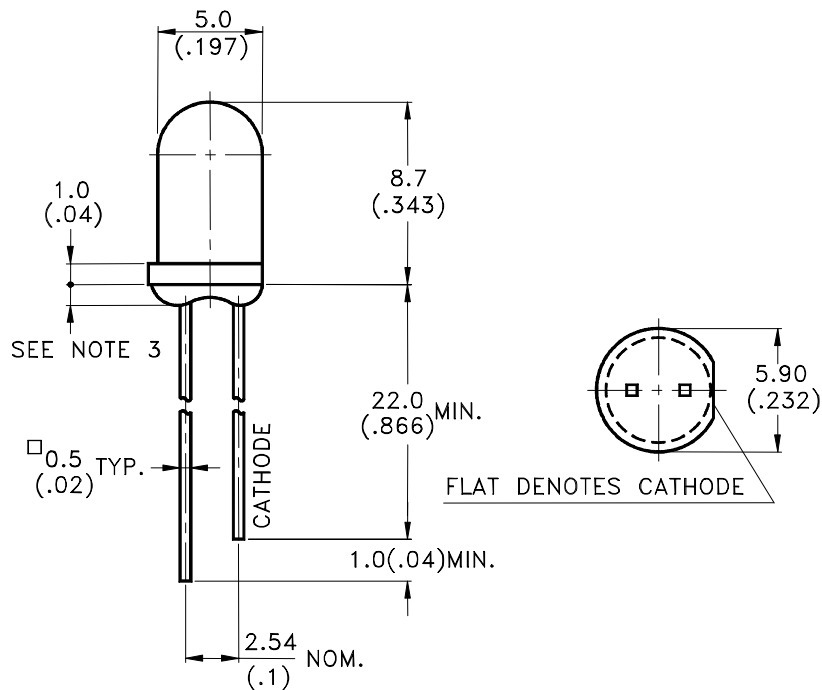

Part No.	Lens	Source Color
LTL2X3SXX	Water Clear	AllnGaP Red/Amber

Notes:

1. All dimensions are in millimeters (inches).
2. Tolerance is ± 0.25 mm (.010") unless otherwise noted.
3. Protruded resin under flange is 1.0mm (.04") max.
4. Lead spacing is measured where the leads emerge from the package.
5. Specifications are subject to change without notice.



Absolute Maximum Ratings at TA=25 °C

Parameter	Red	Amber	Unit
Power Dissipation	130	130	mW
Peak Forward Current (1/10 Duty Cycle, 0.1ms Pulse Width)	100	100	mA
Continuous Forward Current	50	50	mA
Derating Linear From 50 °C	0.6	0.6	mA/°C
Reverse Voltage	5	5	V
Operating Temperature Range	-40 °C to + 100 °C		
Storage Temperature Range	-55 °C to + 100 °C		
Lead Soldering Temperature [1.6mm(.063") From Body]	260 °C for 5 Seconds		

Electrical / Optical Characteristics at TA=25 °C

Parameter	Symbol	Part NO. (LTL)	Min.	Typ.	Max.	Unit	Test Condition
Luminous Intensity	I _v	2P3SEK	2500	4800		mcd	I _F = 20mA Note 1
		2R3SEK	1900	3700			
		2P3SYK	1900	3700			
		2R3SYK	1900	2800			
Viewing Angle	2θ _{1/2}	2P3SXX		22		deg	Note 2 (Fig.5)
		2R3SXX		30			
Peak Emission Wavelength	λ _P	Red		639		nm	Measurement @Peak (Fig.1)
		Amber		594			
Dominant Wavelength	λ _d	Red		630		nm	Note 4
		Amber		592			
Spectral Line Half-Width	Δλ	Red		17		nm	
		Amber		17			
Forward Voltage	V _F	Red		2.0	2.6	V	I _F = 20mA
		Amber		2.15	2.6		
Reverse Current	I _R				100	μA	V _R = 5V
Capacitance	C			40		pF	V _F = 0 , f = 1MHz

NOTE:

- Luminous intensity is measured with a light sensor and filter combination that approximates the CIE eye-response curve.
- θ_{1/2} is the off-axis angle at which the luminous intensity is half the axial luminous intensity.
- I_v classification code is marked on each packing bag.
- The dominant wavelength, λ_d is derived from the CIE chromaticity diagram and represents the single wavelength which defines the color of the device.

Typical Electrical / Optical Characteristics Curves

(25 °C Ambient Temperature Unless Otherwise Noted)

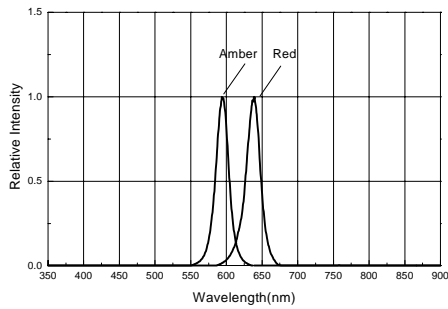

Fig.1 Light emitting wavelength distribution

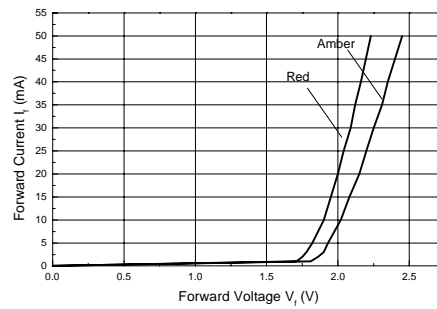

Fig.2 Forward voltage vs. forward current

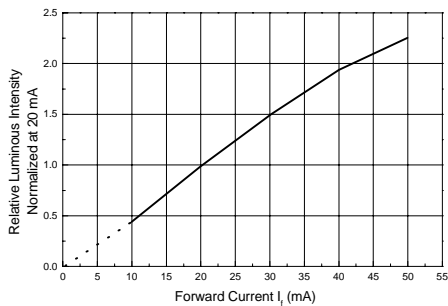

Fig.3 Forward current vs. luminous intensity

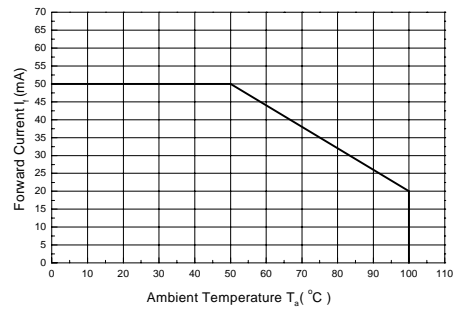

Fig.4 Maximum forward current vs. ambient temperature

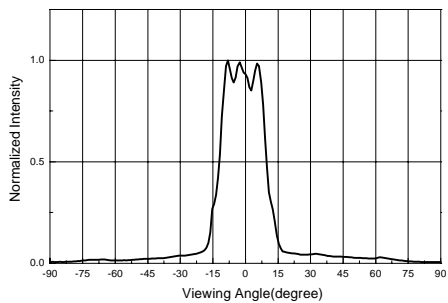

Fig.5 Light pattern of 22° LED lamp

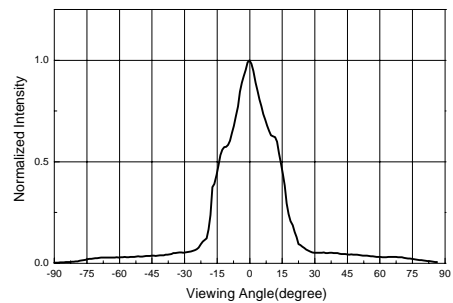

Fig.6 Light pattern of 30° LED lamp

Bin Table of LTL2X3SXX**Intensity Bin Table (Test at 20mA)**

Bin	Luminous Intensity Iv(mcd)	
	Min.	Max.
S	1900	2500
T	2500	3200
U	3200	4200
V	4200	5500
W	5500	7200

Tolerance of each minimum and maximum = $\pm 15\%$ **Forward Voltage Bin Table (Test at 20mA)**

Bin	Forward Voltage Vf (Volts)	
	Min.	Max.
1	1.8	1.9
2	1.9	2.0
3	2.0	2.1
4	2.1	2.2
5	2.2	2.3
6	2.3	2.4
7	2.4	2.5
8	2.5	2.6