

Built-in Sensors

General Catalog 2023

- Infrared Array Sensor / Grid-EYE
- Pressure Sensors

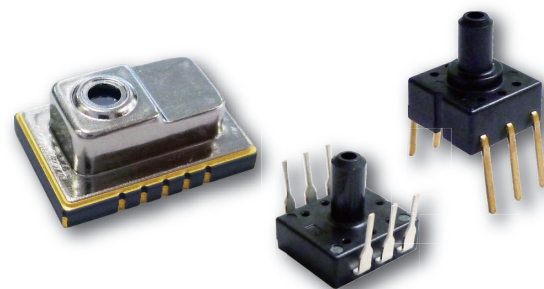

**IN Your
Innovation**

Guidelines and precautions regarding the technical information and use of our products described in this online catalog.

- If you want to use our products described in this online catalog for applications requiring special qualities or reliability, or for applications where the failure or malfunction of the products may directly jeopardize human life or potentially cause personal injury (e.g. aircraft and aerospace equipment, traffic and transportation equipment, combustion equipment, medical equipment, accident prevention, anti-crime equipment, and/or safety equipment), it is necessary to verify whether the specifications of our products fit to such applications. Please ensure that you will ask and check with our inquiry desk as to whether the specifications of our products fit to such applications use before you use our products.
- The quality and performance of our products as described in this online catalog only apply to our products when used in isolation. Therefore, please ensure you evaluate and verify our products under the specific circumstances in which our products are assembled in your own products and in which our products will actually be used.
- Please ensure the safety by means of protection circuit, redundant circuit etc. in your system design in order to prevent the occurrence of life crisis and other serious damages due to the failure of our products.
- The products and product specifications described in this online catalog are subject to change for improvement without prior notice. Therefore, please be sure to request and confirm the latest product specifications which explain the specifications of our products in detail, before you finalize the design of your applications, purchase, or use our products.
- The technical information in this online catalog provides examples of our products' typical operations and application circuits. We do not guarantee the non-infringement of third party's intellectual property rights and we do not grant any license, right, or interest in our intellectual property.
- If any of our products, product specifications and/or technical information in this catalog is to be exported, the laws and regulations of the exporting country, especially with regard to security and export control, shall be observed.

<Regarding the Certificate of Compliance with the EU RoHS Directive/REACH Regulations>

- The switchover date for compliance with the RoHS Directive/REACH Regulations varies depending on the part number or series of our products.
- When you use the inventory of our products for which it is unclear whether those products are compliant with the RoHS Directive/REACH Regulation, please select "Sales Inquiry" in the website inquiry form and contact us.

Please note that we do not owe any liability and responsibility if our products are used beyond the description of this catalog or without complying with precautions in this catalog.

Built-in sensor contributes to energy savings, safety, and comfort.

Providing sensors for various aspects of our lives.

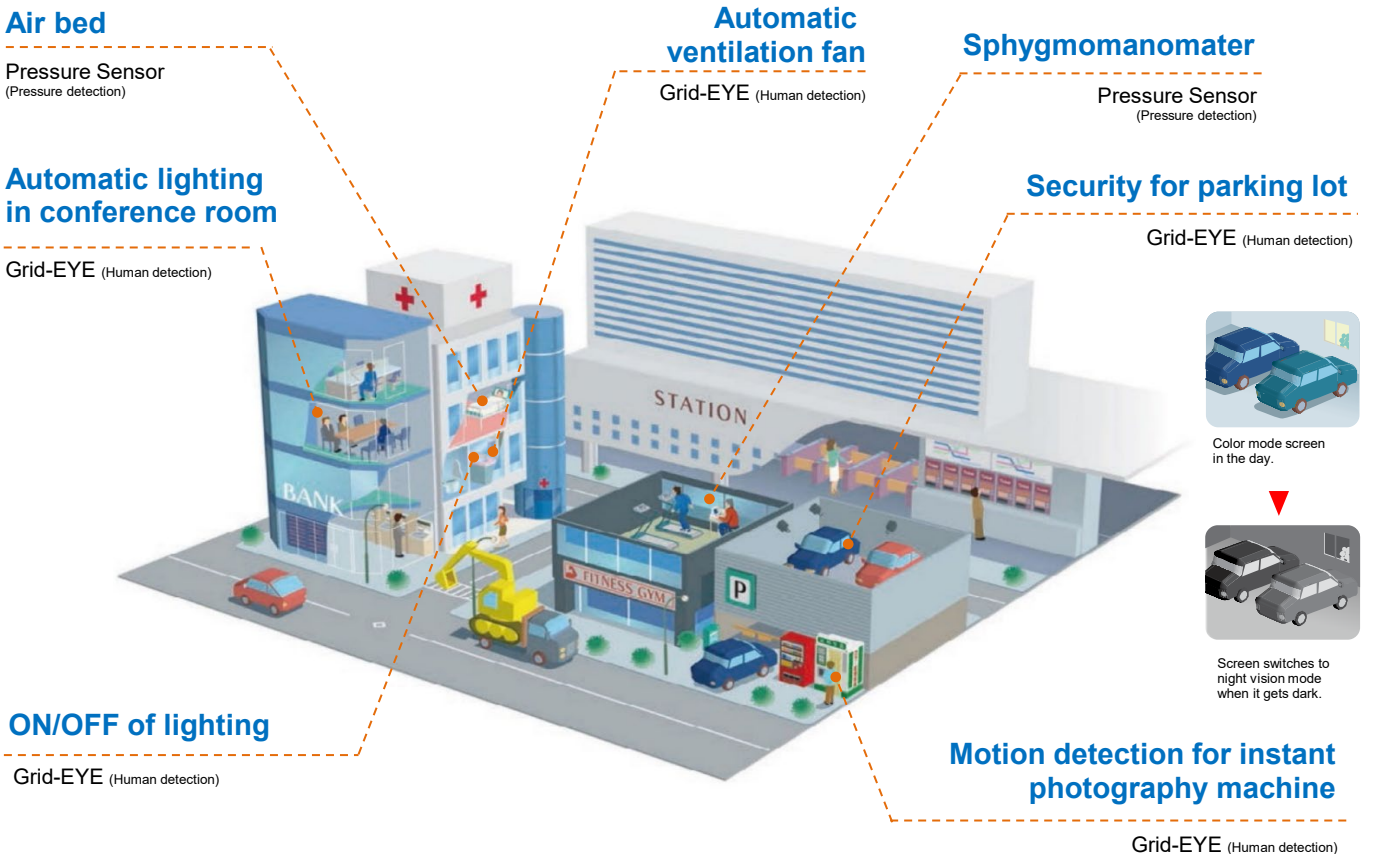
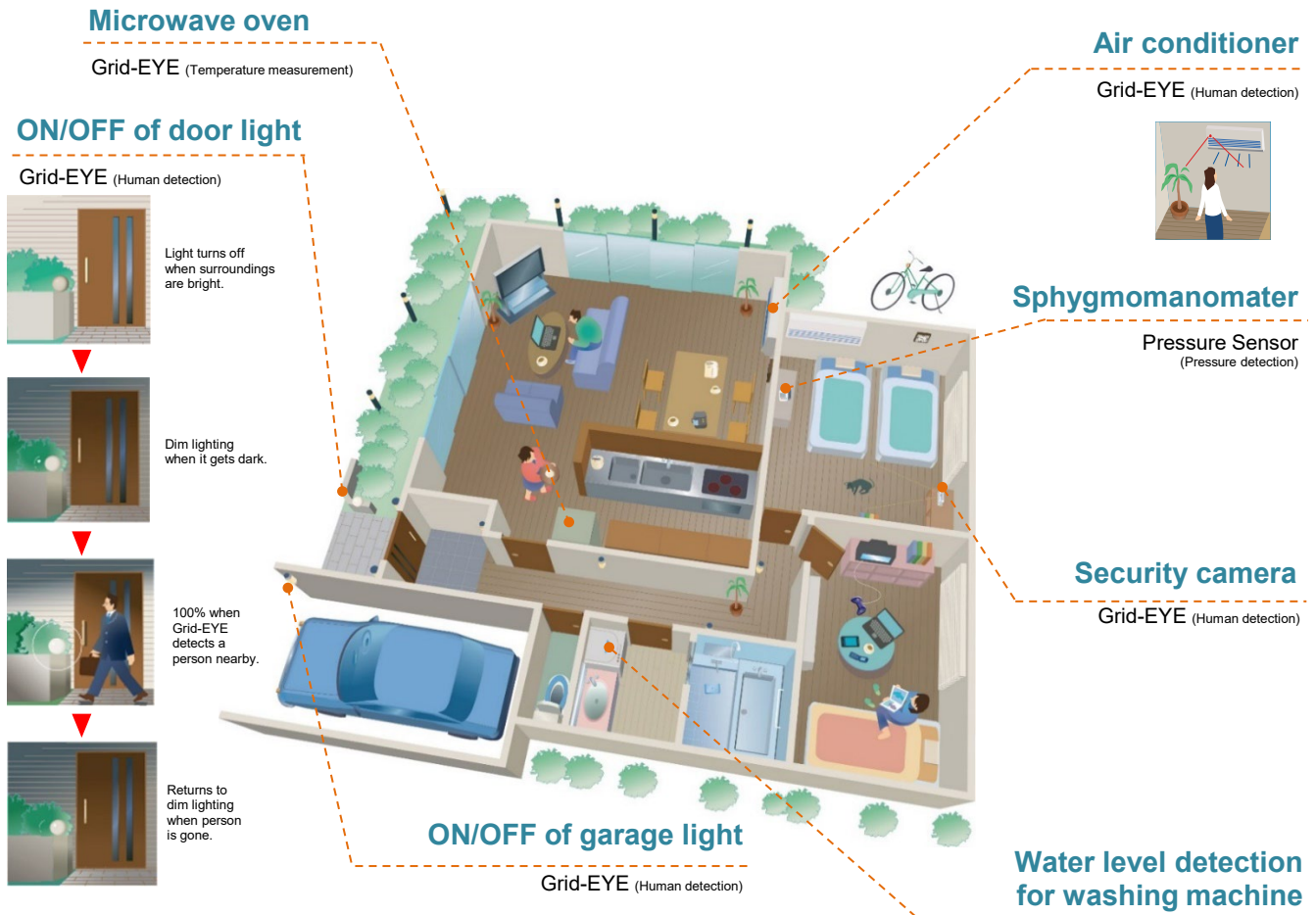

Human Heat

Infrared Array Sensors



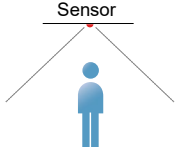





High Precision Infrared Array Sensor based on Advanced MEMS Technology

Product name	Detection method	Type		Characteristics
Thermopile type	Detecting the heat (infrared rays) of the human body and other objects. 	Operating voltage 3.3 V 5.0 V	Amplification factor High gain Low gain	<ul style="list-style-type: none"> ● Temperature detection achieved on a two dimensional area with 8 × 8 (64) pixels. ● Digital output ● Miniature SMD package
Grid-EYE				

Pressure

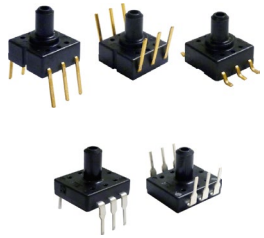
Pressure Sensors

A wide range of rated pressure, including minute pressures

Product name	Pressure medium	Type(*Without glass base type)		Terminal direction	Pressure inlet hole length	Characteristics
PS-A Pressure Sensor 	Air	Rated pressure		Opposite the pressure inlet direction 	3 mm  5 mm 	<ul style="list-style-type: none"> ● Compact pressure sensor with built-in amplification and temperature compensation circuit
		<Low pressure type> 6 kPa			(SMD terminal) 	
PS/PF Pressure Sensor 	Air	Rated pressure	Bridge resistance	Opposite the pressure inlet direction  (SMD terminal) 	—	<ul style="list-style-type: none"> ● Ultra-miniature base area 7.2 (W) x 7.2 (D) mm 0.283 (W) x 0.283 (D) inch
		4.9, 34.3, 49.0, 98.1, 196.1, 343.2, 490.3, 833.6, 980.7 k Pa	5 k Ω			
		* 40 kPa 98.1, 980.7 kPa (PS only)	3.3 k Ω	Pressure inlet direction 	<ul style="list-style-type: none"> ● A wide range of rated pressure, including a minute pressure. 	

Infrared Array Sensor Grid-EYE

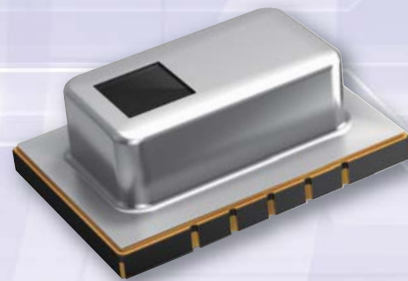



Application Guidelines (AMG88)

1. Safety precautions

Head the following precautions to prevent injury or accidents.

- (1) We take no responsibility for troubles caused by the product usage that is not specified in this specification.
Using the sensors in any way which causes their specifications to be exceeded may generate abnormally high levels of heat, emit smoke, etc., resulting in damage to the circuitry and possibly causing an accident.
- (2) Before connecting a connector, check the pin layout by referring to the connector wiring diagram, specifications diagram, etc., and make sure that the connector is connected properly. Take note that mistakes made in connection may cause unforeseen problems in operation, generate abnormally high levels of heat, emit smoke, etc., resulting in damage to the circuitry.
- (3) If the sensor is abnormally heated or emits an unusual odor, immediately turn off the main power supply to stop operation.
- (4) The fact remains that electrical components and devices generally cause failures at probability. Furthermore, their durability varies with use environments or use conditions. In this respect, we ask you to check for actual electrical components and devices under actual conditions before use without fail.
- (5) The failure modes of this sensor include a short circuit (short-circuit), an open circuit (open-circuit) between each terminal, the occurrence of temperature rise of the equipment (short-circuit), abnormality of a temperature output, etc. If the quality of this sensor is expected to have a significant impact on human life or property, it is recommended to allow a sufficient margin to guarantee characteristics and performance values described in this specification, and to ensure safety by fully considering the fail-safe design shown in the following consideration.
 - Provide protection circuits and protection devices to ensure system safety.
 - Provide of a redundant circuit so that a malfunction does not make the system unsafety.
- (6) If there is any doubt about the safety of this sensor, notify us immediately and make sure to carry out a technical examination at your end.
- (7) Do not disassemble or modify the sensor.

2. Precaution for fundamental structure of sensor

Infrared Array Sensor is a thermopile type infrared sensor which detects the amount of infrared rays.

In general, the sensor output may change in the following cases.

Be sure to check the performance and reliability under actual operating conditions, and correct, if necessary, the output under the actual operating conditions.

If the sensor partially changes temperature.

- If there is a heating element (MCU, power supply, etc.) near the sensor.
- If the sensor unit is exposed to warm or cold air.
- If the sensor body is in contact with the housing of the equipment.

If there is an obstacle between the sensor and the target object.

- If there is an object between the sensor and the target object that does not easily transmit far infrared rays, such as glass, acrylic, or steam.
- If a foreign matter (dust, dirt, water drops, etc.) that inhibits transmissions of far-infrared rays is attached to the lens of the sensor body.

3. Use environment

- (1) Temperature: See the specifications
- (2) Humidity: 15 % to 85 % R.H. (Avoid freezing and dew condensation)
- (3) Atmospheric pressure: 86 to 106 kPa
- (4) Vibrations and shocks may damage the sensor, and cause malfunction and performance deterioration. If loads and shocks are applied on the lense, the damaged sensor may cause malfunction and performance deterioration.
- (5) The product is not water/splash-proof. Therefore, take measures against water, dust, condensation, and freezing depending on the operating environment. If water drops adhere to a soldered part, a short circuit will occur due to solder migration. Therefore, take measures to prevent water from leaking.
- (6) Avoid use and storage in the corrosive gas (organic solvent, sulfurous acid and hydrogen sulfide gases) to avoid malfunction and performance deterioration.
- (7) Use surge absorbers as applying the external surge voltage may damage the internal circuit.
- (8) Malfunction may occur near electric noises from static electricity, lightning, broadcast or amateur radio stations and mobile phones.

(9) The sensor can continuously operate within the range of using ambient temperature (using ambient humidity). However, ensure that humidity is within the range described in the following page as humidity varies according to temperature. Avoid the continuous operation near the operational limit. The temperature range does not guarantee the durability.

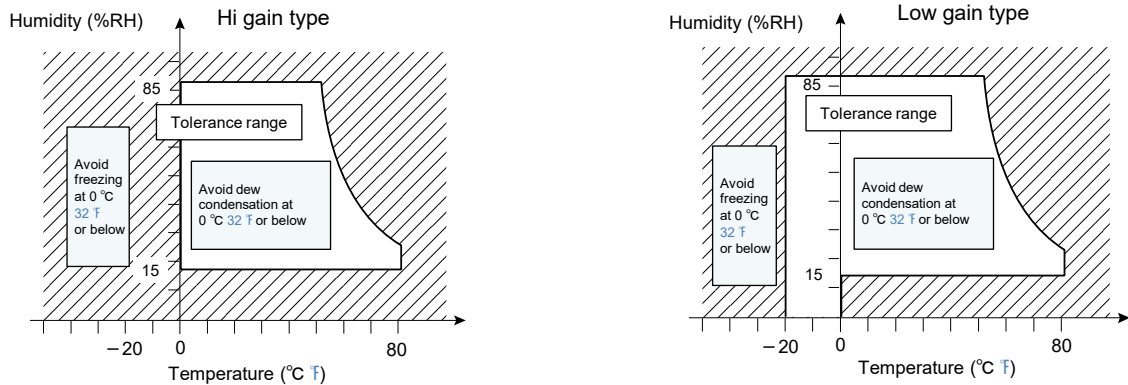

4. Mounting

Use the land of the printed-circuit board on which the sensor is securely fixed. The recommended printed-circuit board is FR4 (thickness 1.6 mm 0.063 inch). When mounting the product on a printed circuit board other than the recommended one, be sure to check the performance and quality before using the product.

- (1) A large noise on the power supply may cause malfunction. Place the recommended capacitor near the sensor (within 20 mm 0.787 inch of the wiring pattern length) between sensor input terminals (VDD-GND) to secure power superimposed noise resistance. Be sure to check on the actual equipment and re-select the optimal capacitor capacity.
- (2) Prevent the metal part of other electronic components from contacting with the sensor body as the upper face (where part numbers are imprinted) of the sensor is GND.

5. Soldering

Due to the thermal capacity of the infrared array sensor is low, therefore, take steps to minimize the effects of external heat. Damage and changes to characteristics may occur due to heat deformation.

5.1 Manual soldering

Set the soldering tip from 350 to 400 °C (30 - 60 W), and solder within 3 seconds or less. Note that output may be changed if the load is applied to the terminals when the soldering carefully clean the tip of soldering iron.

5.2 Reflow soldering

5.2-1 Solder coating

We recommend the screen solder printing method as the method of cream. Halogen type (Chlorine type, Bromine type , etc.) or other high-activity flux is not recommended as the residue may affect performance or reliability of resistors.

5.2-2 Mounting of sensor

Self alignment may not always work as expected, therefore, be carefully the position of the terminals and pattern.

5.2-3 The recommended reflow temperature profile

The recommended reflow temperature profile conditions are given below. The temperature of the profile is assumed to be a value measured with the printed wiring board of the product terminal neighborhood. The temperature of PCB near this product terminal at the time of mounting changes depending on PCB design. The temperature of the printed circuit board near the terminal of this sensor when mounted may change depending on the design of the printed circuit board. Therefore, confirm that the temperature of the printed circuit board near the terminal of this sensor is the specified profile temperature when mounted.

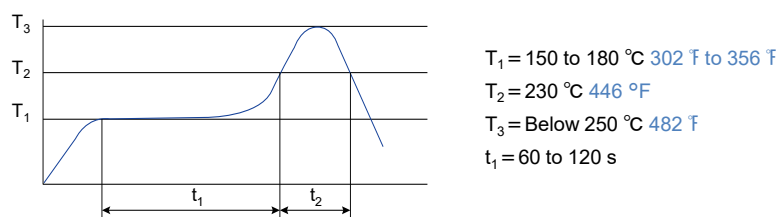

5.3 Solder reworking

Finish reworking in one operation for reworking of the solder bridge, use a soldering iron with a flat tip do not add more flux when reworking Refer the conditions of manual soldering to rework.

5.4 Coating of PCB

To prevent the insulation of the PC board after soldering, not to place the chemicals on lens of the sensor when coating.

5.5 Dividing of PCB

When you cut, fold, or fix with screw the PCB after mounting the sensor, not to stress to the sensor and the soldered parts.

5.6 Structure of sensor terminals

The sensor terminals are designed to be exposed, so contact of the terminals with metal shards and the like will cause output errors. Be careful not to touch the metal pieces with your hands.

5.7 Both-side soldering

When you do the reflow solder to the back of the PC board after the reflow of the sensor, execute fixed processing, or instance, with the adhesive etc.

5.8 Do not touch the sensor with bare hands. Please wear gloves.

6. About wiring

- (1) Correctly wire as in the connection diagram. In particular, be careful not to connect the power supply in the reverse direction as it will result in malfunction and abnormal heat generation.
- (2) Do not use empty terminals. Such use may damage the sensor.
- (3) To avoid the effects of noise, it is recommended to use a shielded cable and keep the length of the cable as short as possible.

7. Cleaning

- (1) If the dirt or water droplets is attached to the lens, wipe it with soft cloth. Wiping too strongly may cause the lens to peel off or scratch the surface of the lens, which may result in malfunction.
- (2) Do not use ultrasonic cleaning as it may cause damage such as wire disconnection.

8. Transportation and storage

- (1) Extreme vibration and shock during transport will damage the sensor. Handle the outer box and reel with care.
- (2) Storage under extreme conditions will cause soldering degradation, external appearance defects, and characteristic deterioration.

The following storage conditions are recommended.

Temperature : 0 °C to 45 °C 32 °F to 113 °F

Humidity : 70 %RH

Others : Not storage in places full of corrosive gases such as sea breeze, Cl₂, H₂S, NH₃, SO₂, and NO_x, minimal dust.

Not storage in places exposed to direct sunlight.

- (3) The sensors are sensitive to moisture and come in moisture-proof packages.
Observe the following cautions when storing.
 - After the moisture-proof package is unsealed, take the sensors out of storage as soon as possible.
(within 1 week, less than 30 °C, less than 60 %R.H.)
 - If the sensors are to be left in storage for a considerable period after the moisture-proof package has been unsealed, keep them in another moisture-proof bag containing silica gel (within 3 months at the most).
- (4) When using the product stored for a long time, dry the package before reflow work.
 - When mounting with solder, if thermal stress is applied to sensors that have absorbed moisture, the moisture will vaporize, swelling will occur, and the inside of the package will become stressed. This may cause the package surface to blister or crack. Cracks, etc., may occur, so be careful in conjunction with the soldering conditions.

9. Other handling cautions

- (1) This product may malfunction if dropped on its own before it is installed. Do not use if this happens.
- (2) If high-frequency vibration is applied to the sensor, it may cause damage. Therefore, do not use products that have been subjected to the following types of impact.
 - Touch to a object made of metal
 - Touch of mutual sensors
- (3) Static electricity may cause this product to malfunction. Take the following precautions when using the product.
 - Store and transport the sensor in an environment where static electricity is unlikely to be generated (for example, 45 to 60% humidity).
 - Store and transport the product in a static-proof container after taking the product out of the taping package.
 - When handling the sensor, wear antistatic clothing and ground your body.
 - Place a conductive plate on the work table and ground the measuring instruments, jigs, and other equipment used.
 - Be sure to ground the customer's equipment used for assembling the equipment.

- (4) Do not use this product which has been disassembled or remodeled.
- (5) Do not reuse this sensor after it has been removed from the printed circuit board.

10. Special remarks

We will do our utmost to control the quality of this product, but please be aware of the following:

- (1) This product is designed to use in general applications at general electric equipment (Household electric appliances, AV products, office equipment, information and equipment, etc.). This product is not an important safety product. This product is not equipped with fail proof/fault diagnosis functions. Therefore, we are not responsible for any loss or damage to life, body, or property caused by the malfunction of this product, in such unsafe events as described in (a) through (d) below.
 - (a) Fire accident (Fire, smoke)
 - (b) Electrocutation (Electric shock)
 - (c) Damages (Fall down/Explosion/Poisoning)
 - (d) Fire/electrocutation/damages at life end
- (2) This catalog shows the quality and performance of individual components. Be sure to evaluate and confirm them in the condition in which they are mounted on your products and in the actual operating environment when using the products.
- (3) The warranty period for this product is one year after purchase or delivery to the designated location unless otherwise specified between both parties.
- (4) In the event that we are found to blame for any failures or defects in our products during the warranty period, we will provide replacements or supply the necessary spare parts or replace and/or repair the defective sections free of charge and with all due speed at the location where the products concerned were purchased or delivered. However, the following failures and defects are not covered by the warranty:
 - When the failure or defect was caused by a specification, standard, handling method, etc. which was specified by you.
 - When the failure or defect was caused after purchase by you or delivery to your premises by an alteration in construction, performance, specification, etc. which did not involve us.
 - The case that the product condition changed by handling, storage and / or transportation after delivery.
 - When the failure or defect was caused by a phenomenon that could not be predicted by the technology that was being applied in practice either after purchase by you or at the time when the contract was signed.
 - If the product is used outside the range of conditions and environments described in this catalog.
 - When, after our products were incorporated into your products or equipment for use, damage resulted which could have been avoided if your products or equipment had been equipped with the functions, construction, etc. the provision of which is accepted practice in the industry.
 - When the failure or defect was caused by a natural disaster or other force majeure. The terms and conditions of the warranty here set forth apply solely to the warranty of the discrete products which were purchased by you or delivered to your premises, and they do not cover any damage induced by their failure or defects.
- (5) Products and specifications described in this catalog are subject to change (including specification changes and discontinuation) due to product improvements or other reasons. When considering the use of this product for a new product, contact us and confirm that the information described in these specifications is the latest available.
- (6) Have the product you purchased undergo an acceptance inspection as soon as possible, and take sufficient care in the management and maintenance of the product before and during the acceptance inspection.
- (7) As to the disposal of the product, check the method of disposal in each country or region where the product are incorporated in your products to be used.
- (8) The technical information contained in this catalog is intended to provide examples of typical product operation and applicable circuits and does not constitute a guarantee of non-infringement of intellectual property rights or a license to use such information by us or any third party.

Infrared Array Sensor Grid-EYE

Surface Mount Type

AMG88xx (High performance type)

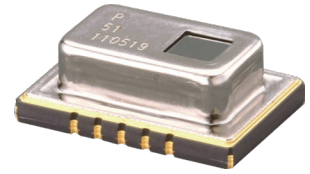

High precision infrared array sensor based on advanced MEMS technology

Feature

- Temperature detection of two-dimensional area: 8 × 8 (64 pixels)
- Digital output (capability of temperature value output)
- Compact SMD package (adaptively to reflow mounting)
- RoHS compliant

Recommended applications

- Home appliances (Microwaves and air-conditioners)
- Building automation (People counting, Air conditioning control)
- Home automation (People detection)
- Factory automation (Fault prevention)

Ordering information

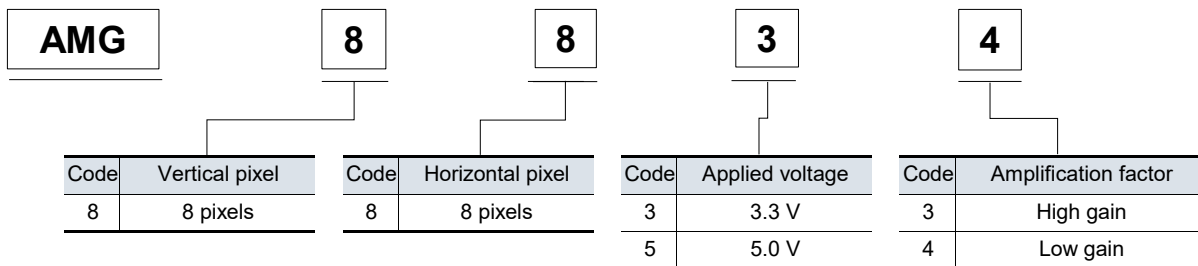

Types

Product name	Number of pixel	Operating voltage	Amplification factor	Part number	Tape and reel package (pcs)
Infrared array sensor Grid-EYE	64 (Vertical 8 × Horizontal 8 Matrix)	3.3 V	High gain	AMG8833	1000
			Low gain	AMG8834	
		5.0 V	High gain	AMG8853	
			Low gain	AMG8854	

Rating

Item	Performance	
	High gain	Low gain
Applied voltage	3.3 V ± 0.3 V or 5.0 V ± 0.5 V	
Temperature range of measuring object	0 °C to 80 °C +32 °F to +176 °F	-20 °C ~ 100 °C -4 °F to +212 °F
Operating temperature range	0 °C to 80 °C +32 °F to +176 °F	-20 °C ~ 80 °C -4 °F to +176 °F
Storage temperature range	-20 °C to 80 °C -4 °F to +176 °F	-20 °C ~ 80 °C -4 °F to +176 °F

Absolute maximum ratings

Item	Absolute maximum ratings	Terminal
Applied voltage	-0.3 V to 6.5 V	VDD
Input voltage	-0.3 V to VDD +0.3 V	SCL, SDA, AD_SELECT
Output sink current	-10 mA to 10 mA	INT, SDA
Static electricity (Human Body Model)	1 kV	All terminals
Static electricity (Machine Model)	200 V	All terminals

Characteristics

Item	Performance	
	High gain	Low gain
Temperature accuracy	Typ. $\pm 2.5\text{ }^{\circ}\text{C}$ $\pm 4.5\text{ }^{\circ}\text{F}$	Typ. $\pm 3.0\text{ }^{\circ}\text{C}$ $\pm 5.4\text{ }^{\circ}\text{F}$
NETD ^{*1}	Typ. 0.05 K (in 1 fps setting ^{*2}) Typ. 0.16 K (in 10 fps setting)	
Viewing angle	Typ. 60 °	
Current consumption	Typ. 4.5 mA (normal mode) Typ. 0.2 mA (sleep mode)	
Setup time	Typ. 50 ms (Time to enable communication after setup) Typ. 15 s (Time to stabilize output after setup)	

*1: It is calculated from 4 pixels of centers.

*2: fps: frame per second

Performance

Item	Performance
Number of pixel	64 (Vertical 8 × Horizontal 8 Matrix)
External interface	I ² C
Frame rate	Typ. 1 fps or Typ. 10 fps
Operating mode ^{*3}	Normal Sleep
Output mode	Temperature output
Calculate mode	No moving average or Twice moving average
Temperature output resolution	0.25 °C 0.45 °F
Number of sensor address	2 (I ² C slave address)
Thermistor output temperature range	-20 °C to 80 °C -4 °F to +176 °F
Thermistor output resolution	0.0625 °C 0.1125 °F

*3: Normal Mode : normal operation mode; Sleep Mode: detection is off (output and data reading not possible)

Internal circuit

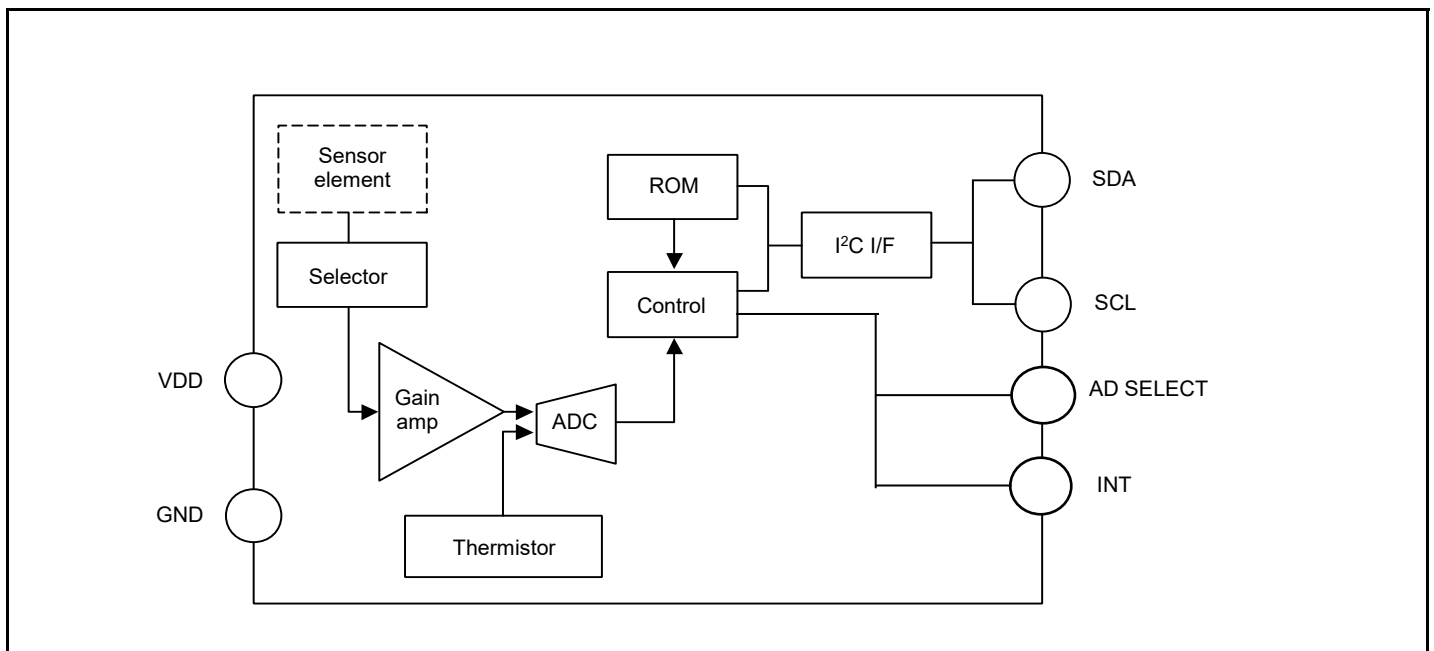

Pixel array and viewing angle

(1) Pixel array

Pixel array from 1 to 64 is shown below.

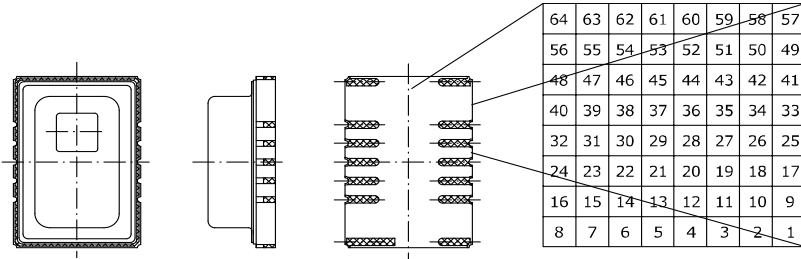

(2) Viewing angle (Typ.)

Sensor viewing angle is shown below.

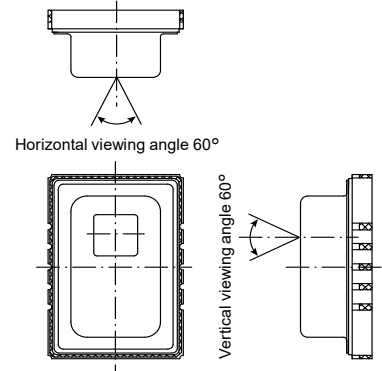

Optical properties

(1) Each pixel's viewing central angle (Typ.)

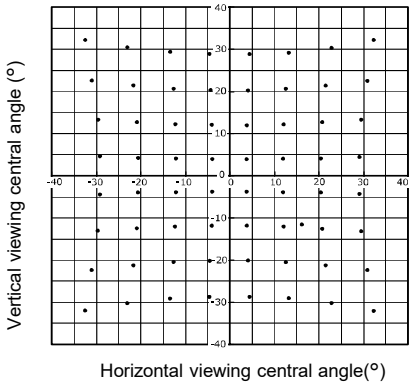

(2) Each pixel's viewing angle (Typ.)

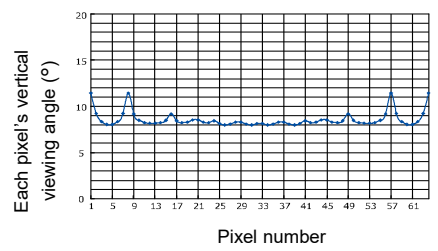
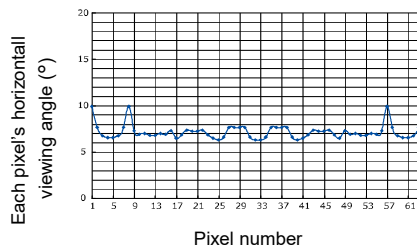

Dimensions

External dimensions (Typ.)

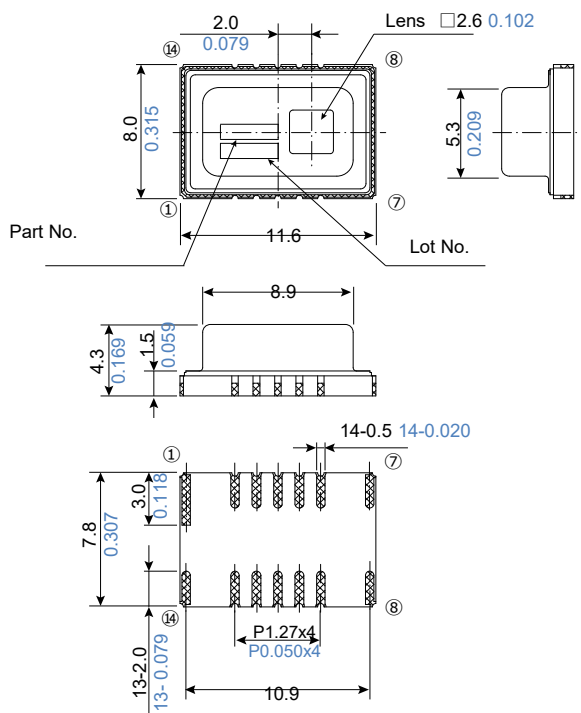

Recommended PC board pad (Typ.)

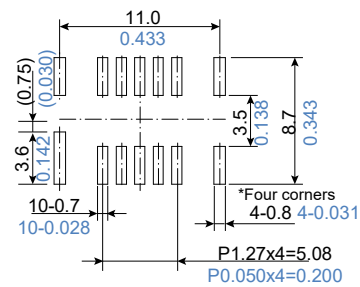

Number	Terminal name
①	NC
②	SDA
③	SCL
④	INT
⑤	AD_SELECT
⑥	GND
⑦	NC

Number	Terminal name
⑧	NC
⑨	VDD
⑩	AVDD-PC
⑪	NC
⑫	DVDD-PC
⑬	VPP
⑭	NC

Note) NC : Leave terminal unconnected.

Unit : mm inch

External circuit

(1) In case of setting I2C slave address of the sensor 1101000

※ Connect terminal 5 (AD_SELECT) to GND.

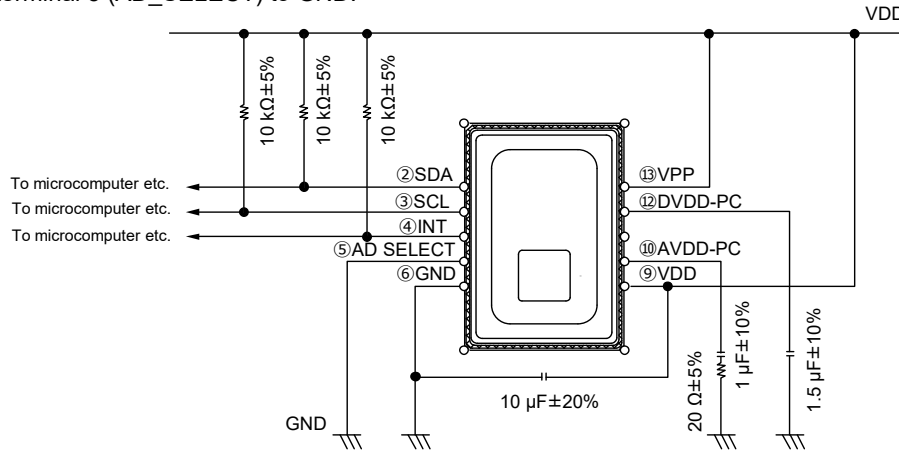

(2) In case of setting I2C slave address of the sensor 1101001

※ Connect terminal 5 (AD_SELECT) to VDD.

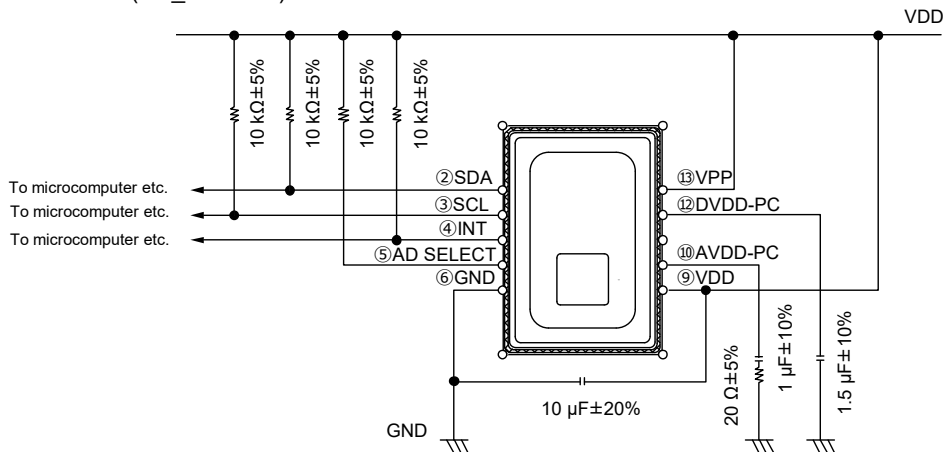

- This circuit is an example to drive Infrared Array Sensor “Grid-EYE”, so that our company will not take any responsibility of loss which is due to this circuit.
- The wiring connected to VDD are same electrical potential (same supply voltage).
- If there is a difference of electric potential between the terminals, it can be cause of breakdown.
- Connect wiring to solid GND with wide and short pattern on PCB.
- If wiring pattern is designed thin and long, temperature accuracy will be degraded.

Packing format (Tape and reel)

Tape dimensions (Typ.)

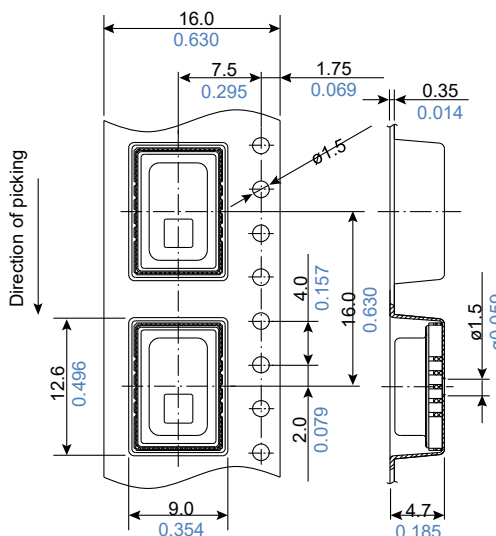

Dimensions of tape reel (Typ.)

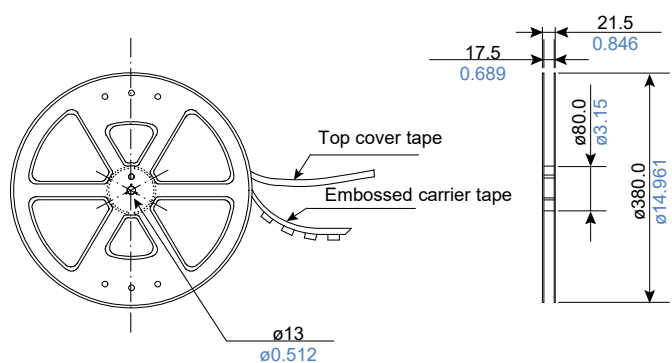

Unit : mm inch

Carton packing

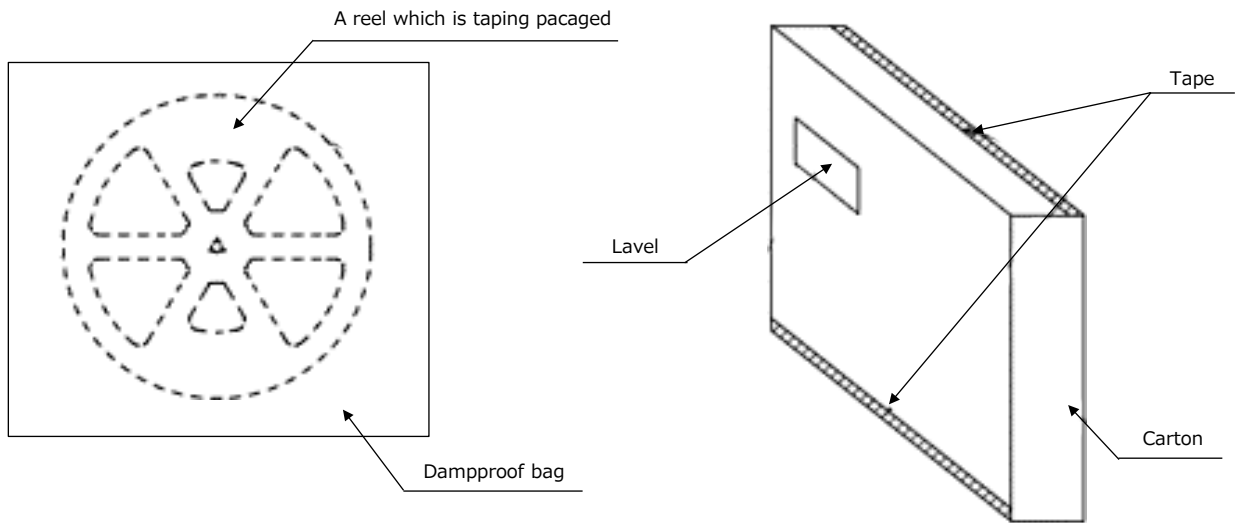

1. The number packed by 1 reel is up to 1000 pcs.
2. The end of the carrier tape are fixed by tape.
3. Inside the dampproof bag is not deaerated

Infrared Array Sensor Grid-EYE

Surface Mount Type

AMG88x543 (Wide angle type)

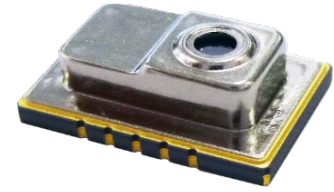

Feature

- Temperature detection of two-dimensional area: 8 × 8 (64 pixels)
- Digital output (capability of temperature value output)
- Compact SMD package (adaptively to reflow mounting)
- RoHS compliant

Recommended applications

- Energy saving at office (air-conditioning/lighting control)
- Automatic doors/elevators

Ordering information

AMG		8		8		3		543
Code	Vertical pixel	Code	Horizontal pixel	Code	Power supply voltage	Code	Fixed value	Code
8	8 pixels	8	8 pixels	3	3.3 V	543	Fixed value	
				5	5.0 V			

Types

Product name	Number of pixel	Operating voltage	Part number	Tape and reel package (pcs)
Infrared array sensor Grid-EYE	64 (Vertical 8 × Horizontal 8 Matrix)	3.3 V	AMG883543	1000
		5.0 V	AMG885543	

Rating

Item	Performance
Applied voltage	3.3 V ± 0.3 V or 5.0 V ± 0.5 V
Temperature range of measuring object	0 °C to 80 °C +32 °F to +176 °F
Operating temperature range	0 °C to 80 °C +32 °F to +176 °F
Storage temperature range	-20 °C to 80 °C -4 °F to +176 °F

Absolute maximum ratings

Item	Absolute maximum ratings	Terminal
Applied voltage	-0.3 V to 6.5 V	VDD
Input/Output voltage	-0.3 V to VDD +0.3 V	SCL, SDA, AD_SELECT
Output sink current	-10 mA to 10 mA	INT, SDA
Static electricity (Human Body Model)	± 1 kV	All terminals
Static electricity (Machine Model)	± 200 V	All terminals

Characteristics

Item	Performance
Temperature accuracy ^{*1 *2}	Average value of total pixels is within Typ. $\pm 2.5^{\circ}\text{C}$ $\pm 4.5^{\circ}\text{F}$
NETD ^{*3}	1fps: Typ. 0.09°C 10fps: Typ. 0.27°C
Viewing angle	Typ. 90°
Optical axis gap	Within Typ. $\pm 10^{\circ}$
Current consumption	Typ. 4.5 mA (Normal mode) Typ. 0.2 mA (Sleep mode)
Setup time	Typ. 50 ms (Time to enable communication after setup) Typ. 15 s (Time to stabilize output after setup)

*1: Temperature output after starting in normal mode and waiting longer than setup time.

*2: The measurement conditions for guaranteed characteristic are as follows.

- Measurement equipment : inspection equipment in our manufacturing process
- Ambient humidity : standard humidity (Around 65%RH)
- Frame rate : 10fps
- Operation temperature : standard temperature (Around 20°C)

- Measurement object and temperature : black body, 25°C , 50°C , 75°C
- Moving average : setting off
- Measurement value of each pixel: Average value of multiple frame outputs
- Average value of all pixels: Average value of total pixels measurement values

*3: This value are central 4 pixels which are No.28, No.29, No.36, No.37.

Performance

Item	Performance
Number of pixel	64 (Vertical 8 × Horizontal 8 Matrix)
External interface	I ² C
Frame rate	Typ. 1 fps or Typ. 10 fps
Operating mode	Normal (Detection on) Sleep (Detection off)
Output mode	Temperature output
Calculate mode	No moving average or Twice moving average
Temperature output resolution	0.25°C 0.45°F
Number of sensor address	2 (I ² C slave address))
Thermistor output temperature range	-20°C to 80°C -4°F to $+176^{\circ}\text{F}$
Thermistor output resolution	0.0625°C 0.1125°F

Internal circuit

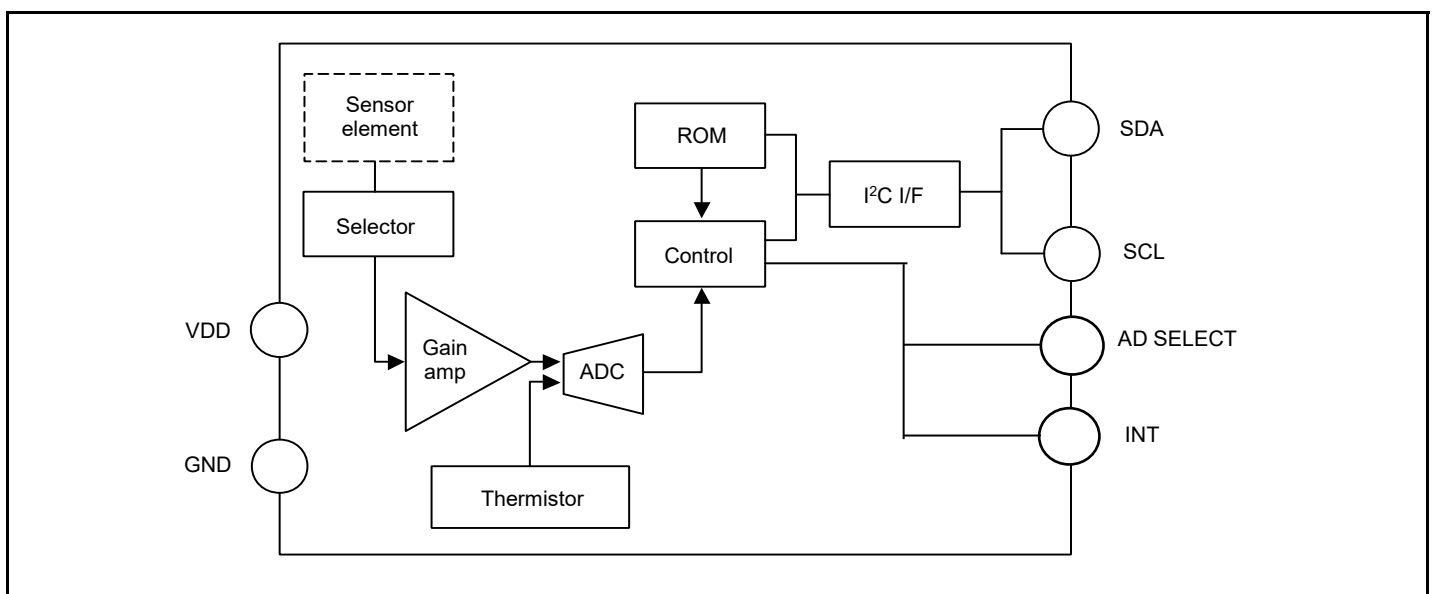

Pixel array and viewing angle

(1) Pixel array

Pixel array from 1 to 64 is shown below.

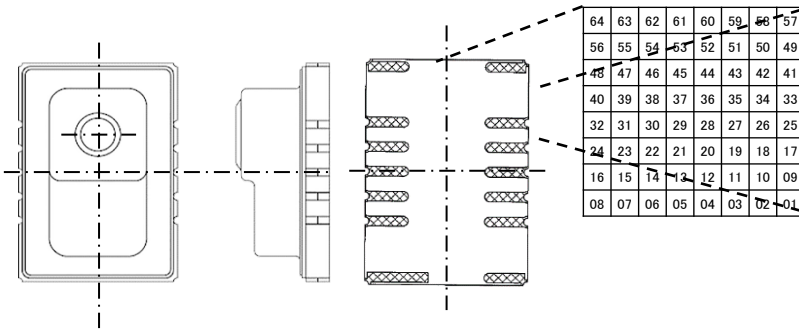

(2) Viewing angle (Typ.)

Sensor viewing angle is shown below.

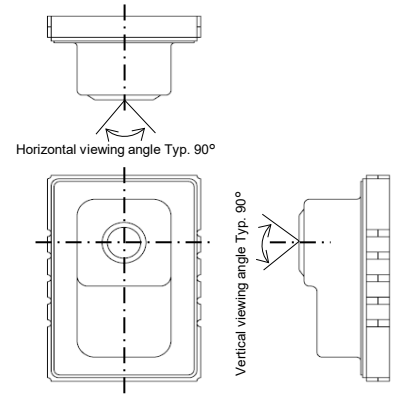

Optical properties

(1) Each pixel's viewing central angle (Typ.)

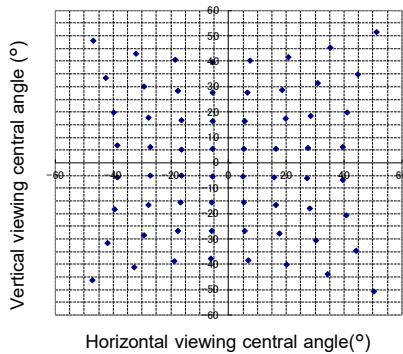

(2) Each pixel's viewing angle (Typ.)

Sensor viewing angle is shown below.

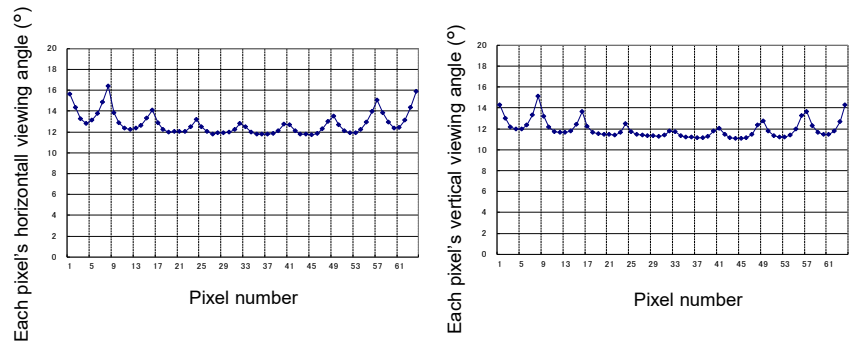

Dimensions

External dimensions (Typ.)

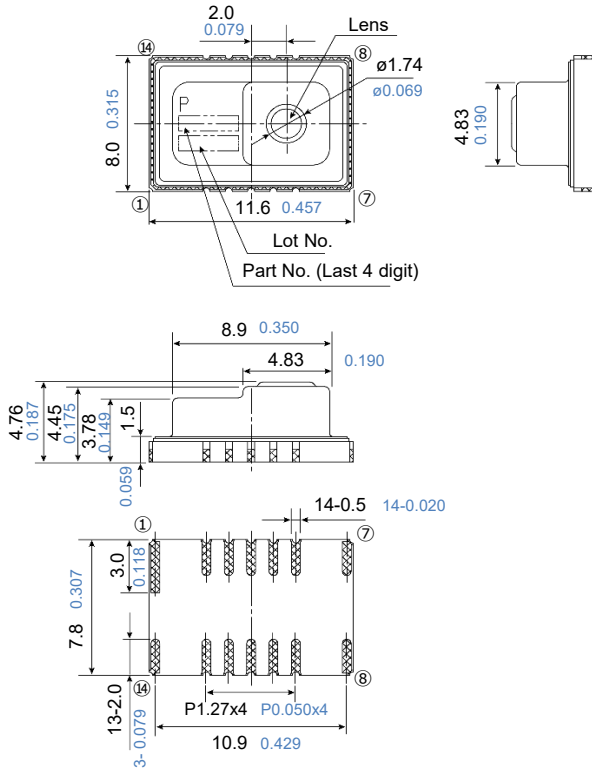

Recommended PC board pad (Typ.)

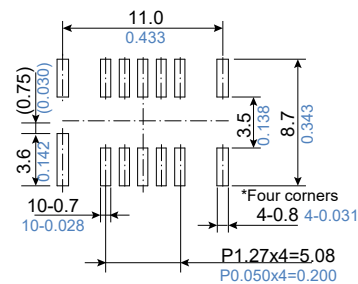

Number	Terminal name
①	NC
②	SDA
③	SCL
④	INT
⑤	AD_SELECT
⑥	GND
⑦	NC

Number	Terminal name
⑧	NC
⑨	VDD
⑩	AVDD-PC
⑪	NC
⑫	DVDD-PC
⑬	VPP
⑭	NC

Note) NC : Leave terminal unconnected.

Unit : mm inch

External circuit

(1) In case of setting I2C slave address of the sensor 1101000

※ Connect terminal 5 (AD_SELECT) to GND.

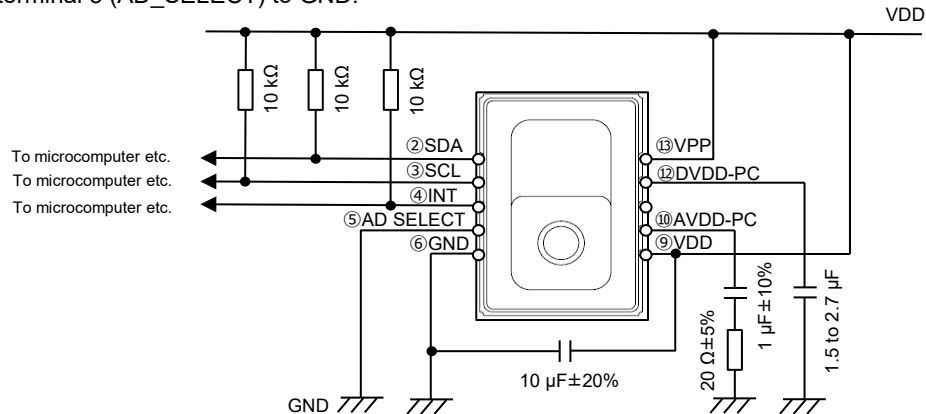

(2) In case of setting I2C slave address of the sensor 1101001

※ Connect terminal 5 (AD_SELECT) to VDD.

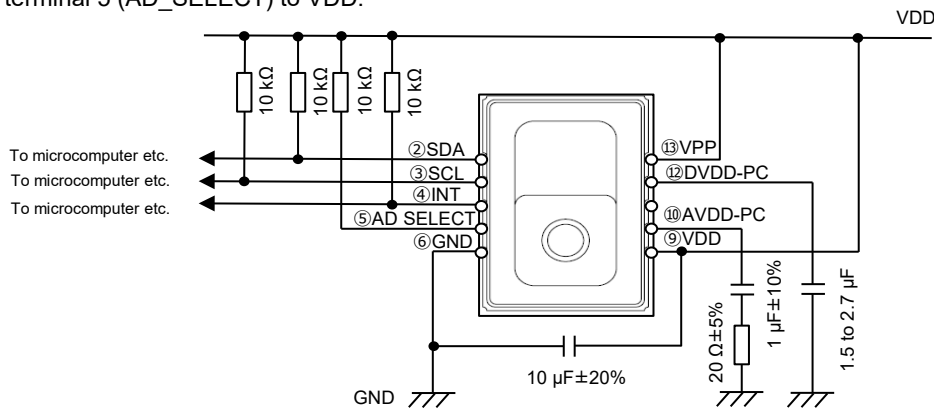

- This circuit is an example to drive Infrared Array Sensor “Grid-EYE”, so that our company will not take any responsibility of loss which is due to this circuit.
- The wiring connected to VDD are same electrical potential (same supply voltage).
- If there is a difference of electric potential between the terminals, it can be cause of breakdown.
- Connect wiring to solid GND with wide and short pattern on PCB.
- If wiring pattern is designed thin and long, temperature accuracy will be degraded.

Packing format (Tape and reel)

Tape dimensions (Typ.)

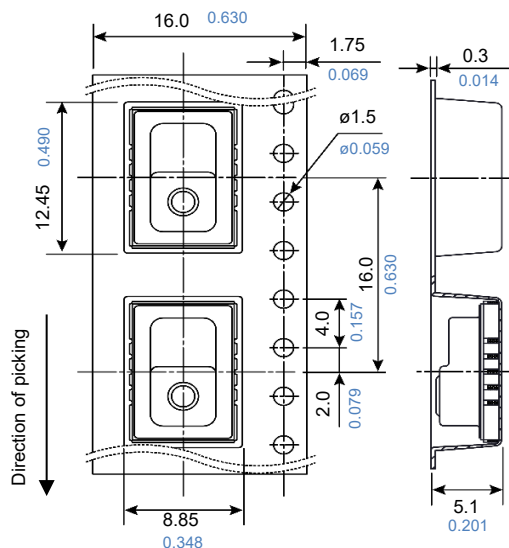

Dimensions of tape reel (Typ.)

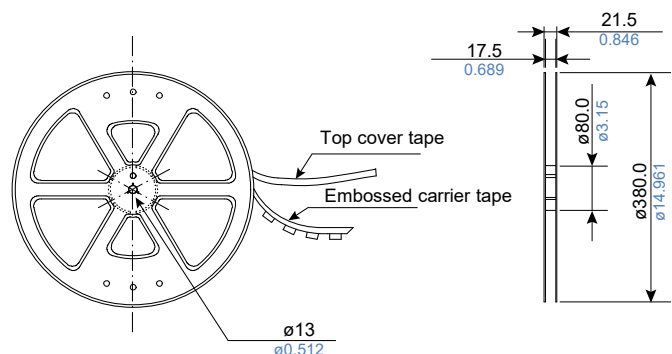

Unit : mm inch

Infrared Array Sensor Grid-EYE

Surface Mount Type

AMG883642 (Narrow type)

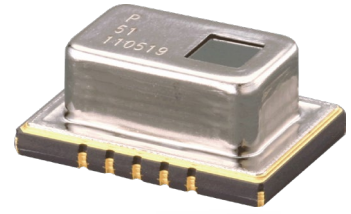

High precision infrared array sensor based on advanced MEMS technology

Feature

- Temperature detection of two-dimensional area: 8 × 8 (64 pixels)
- Digital output (capability of temperature value output)
- Compact SMD package (adaptively to reflow mounting)
- RoHS compliant

Recommended applications

- Home appliances (Microwaves and air-conditioners)
- Building automation (People counting, Air conditioning control)
- Home automation (People detection, heat source detection)
- Factory automation (Fault prevention)

Ordering information

AMG	8	8	3	642			
Code	Vertical pixel	Code	Horizontal pixel	Code	Power supply voltage	Code	Field of view
8	8 pixels	8	8 pixels	3	3.3 V	642	Horizontal Typ.35.6° Vertical Typ.35.6°

Types

Product name	Number of pixel	Operating voltage	Part number	Tape and reel package (pcs)
Infrared array sensor Grid-EYE	64 (Vertical 8 × Horizontal 8 Matrix)	3.3 V	AMG883642	800

Rating

Item	Performance
Applied voltage	3.3 V ± 0.3 V
Temperature range of measuring object	-20 °C ~ 100 °C -4 °F to +212 °F
Operating temperature range	-20 °C ~ 80 °C -4 °F to +176 °F
Storage temperature range	-20 °C ~ 80 °C -4 °F to +176 °F

Absolute maximum ratings

Item	Absolute maximum ratings	Terminal
Applied voltage	-0.3 V to 6.5 V	VDD
Input voltage	-0.3 V to VDD +0.3 V	SCL, SDA, AD_SELECT
Output sink current	-10 mA to 10 mA	INT, SDA
Static electricity (Human Body Model)	1 kV	All terminals
Static electricity (Machine Model)	200 V	All terminals

Characteristics

Item	Performance
Temperature accuracy	Typ. $\pm 3.0\text{ }^{\circ}\text{C}$ $\pm 5.4\text{ }^{\circ}\text{F}$
NETD ^{*1}	Typ. 0.11 K (in 1 fps setting ^{*2}) Typ. 0.35 K (in 10 fps setting)
Viewing angle	Typ. 35.6 °
Current consumption	Typ. 4.5 mA (normal mode) Typ. 0.2 mA (sleep mode)
Setup time	Typ. 50 ms (Time to enable communication after setup) Typ. 15 s (Time to stabilize output after setup)

*1: It is calculated from 4 pixels of centers.

*2: fps: frame per second

Performance

Item	Performance
Number of pixel	64 (Vertical 8 × Horizontal 8 Matrix)
External interface	I ² C
Frame rate	Typ. 1 fps or Typ. 10 fps
Operating mode ^{*3}	Normal Sleep
Output mode	Temperature output
Calculate mode	No moving average or Twice moving average
Temperature output resolution	0.25 °C 0.45 °F
Number of sensor address	2 (I ² C slave address))
Thermistor output temperature range	-20 °C to 80 °C -4 °F to +176 °F
Thermistor output resolution	0.0625 °C 0.1125 °F

*3: Normal Mode : normal operation mode; Sleep Mode: detection is off (output and data reading not possible)

Internal circuit

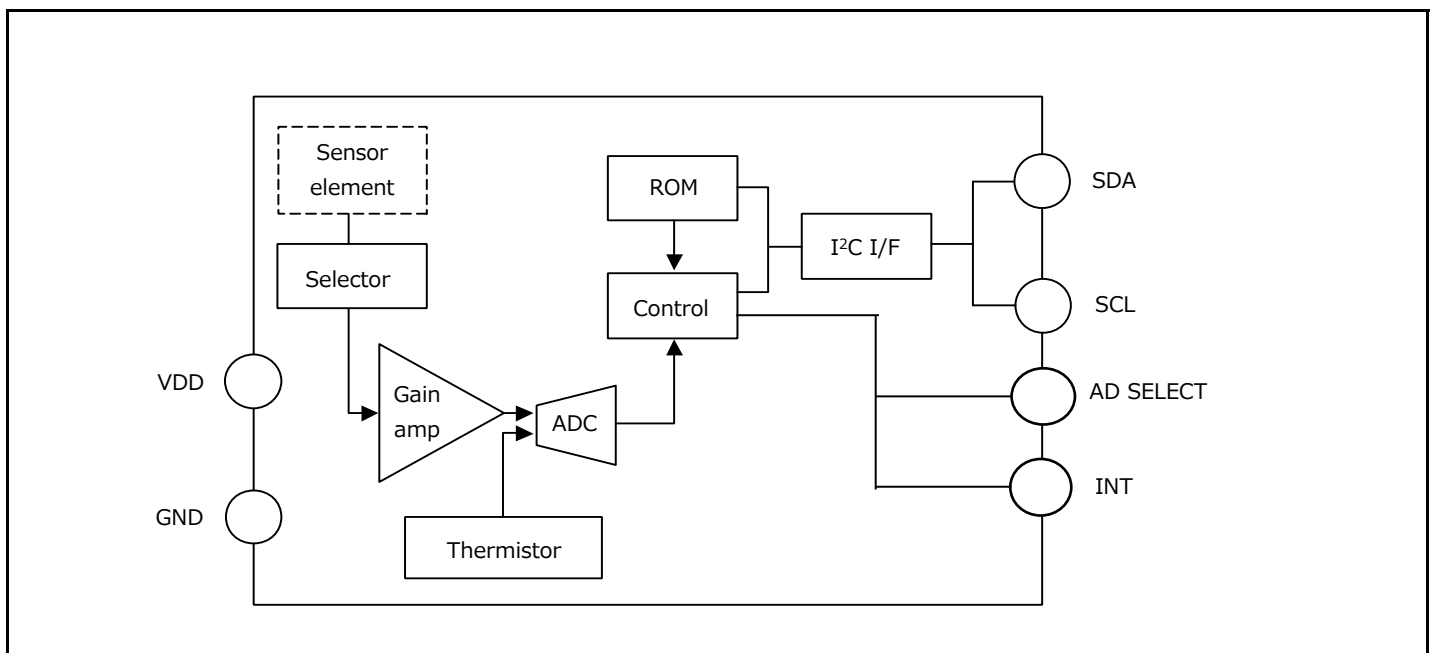

Pixel array and viewing angle

(1) Pixel array

Pixel array from 1 to 64 is shown below.

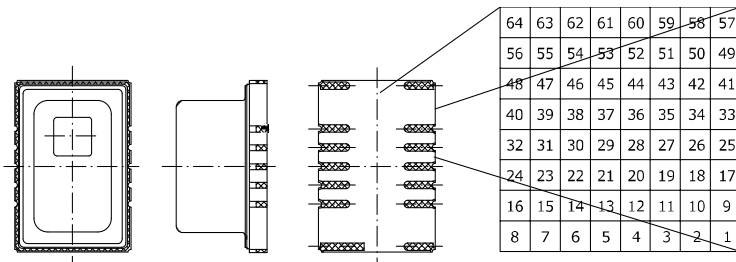

(2) Viewing angle (Typ.)

Sensor viewing angle is shown below.

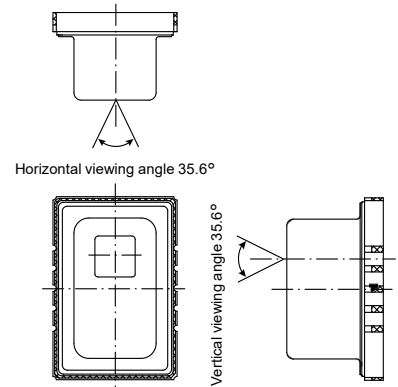

Optical properties

(1) Each pixel's viewing central angle (Typ.)

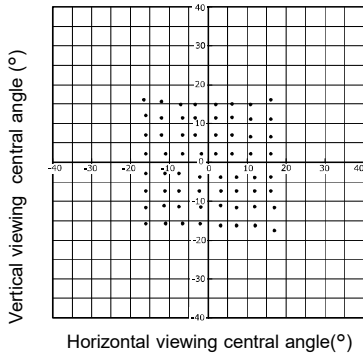

(2) Each pixel's viewing angle (Typ.)

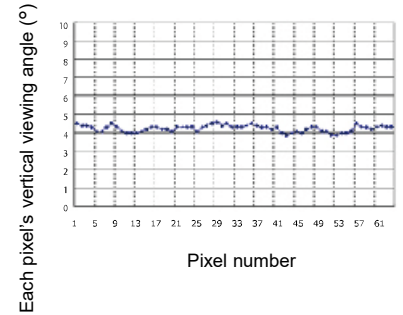
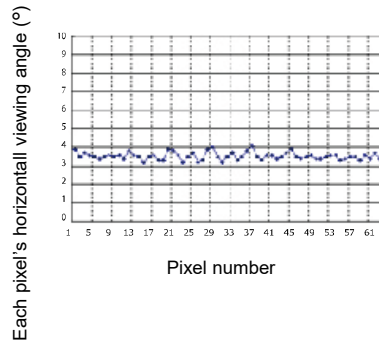

Dimensions

External dimensions (Typ.)

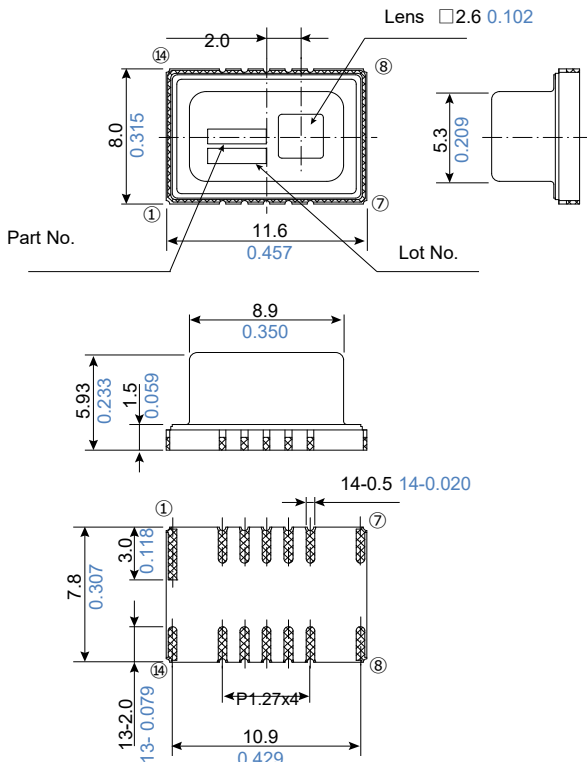

Recommended PC board pad (Typ.)

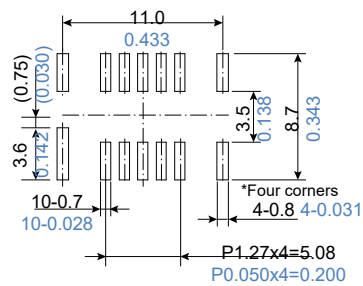

Number	Terminal name
①	NC
②	SDA
③	SCL
④	INT
⑤	AD_SELECT
⑥	GND
⑦	NC

Number	Terminal name
⑧	NC
⑨	VDD
⑩	AVDD-PC
⑪	NC
⑫	DVDD-PC
⑬	VPP
⑭	NC

Note) NC : Leave terminal unconnected.

Unit : mm inch

External circuit

(1) In case of setting I2C slave address of the sensor 1101000

※ Connect terminal 5 (AD_SELECT) to GND.

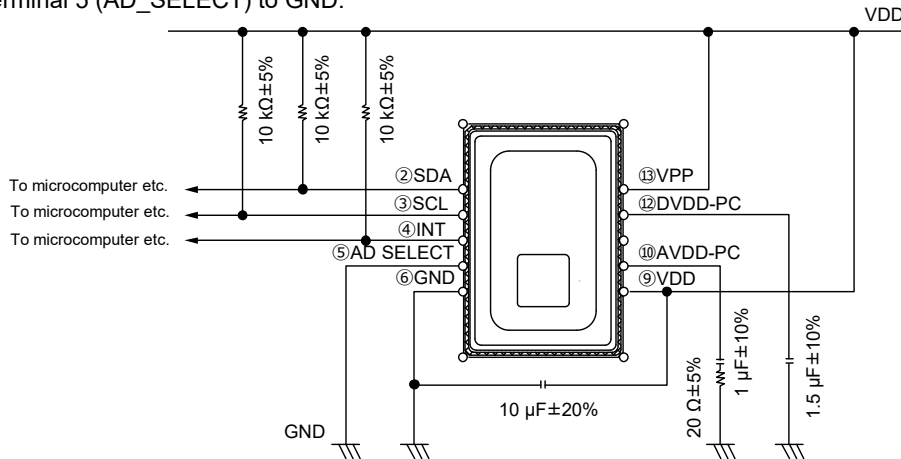

(2) In case of setting I2C slave address of the sensor 1101001

※ Connect terminal 5 (AD_SELECT) to VDD.

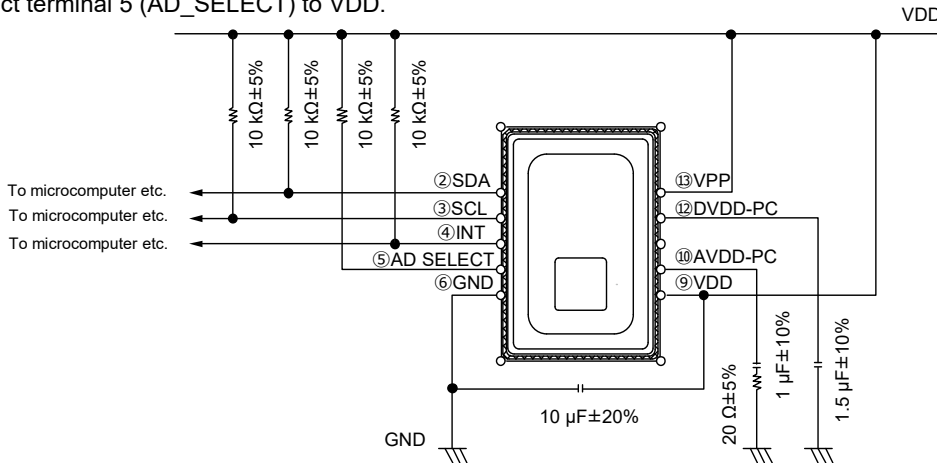

- This circuit is an example to drive Infrared Array Sensor “Grid-EYE”, so that our company will not take any responsibility of loss which is due to this circuit.
- The wiring connected to VDD are same electrical potential (same supply voltage).
- If there is a difference of electric potential between the terminals, it can be cause of breakdown.
- Connect wiring to solid GND with wide and short pattern on PCB.
- If wiring pattern is designed thin and long, temperature accuracy will be degraded.

Packing format (Tape and reel)

Tape dimensions (Typ.)

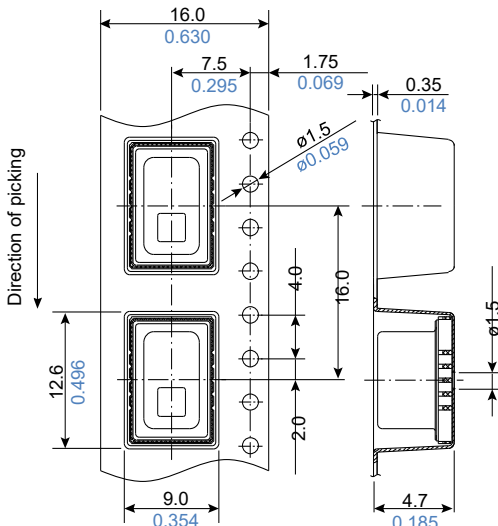

Dimensions of tape reel (Typ.)

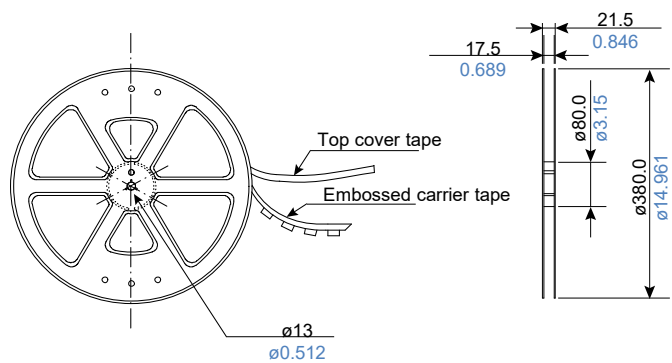

Unit : mm inch

⚠ Application Guidelines (AMG8854M01)

1. Safety precautions

Head the following precautions to prevent injury or accidents.

- (1) We take no responsibility for troubles caused by the product usage that is not specified in this specification. Using the sensors in any way which causes their specifications to be exceeded may generate abnormally high levels of heat, emit smoke, etc., resulting in damage to the circuitry and possibly causing an accident.
- (2) Before connecting a connector, check the pin layout by referring to the connector wiring diagram, specifications diagram, etc., and make sure that the connector is connected properly. Take note that mistakes made in connection may cause unforeseen problems in operation, generate abnormally high levels of heat, emit smoke, etc., resulting in damage to the circuitry.
- (3) If the module heats up abnormally or smells abnormal, stop using it immediately by turning off the main power supply of the device etc.
- (4) The fact remains that electrical components and devices generally cause failures at probability. Furthermore, their durability varies with use environments or use conditions. In this respect, we ask you to check for actual electrical components and devices under actual conditions before use without fail.
- (5) Failure modes of sensors include short-circuiting, open-circuiting and temperature rises. If the failure of the product is considered to cause a personal injury or death or property damage, the safety rate should be added to the specified values shown in this specifications and please consider the fail-safe design in the following considerations and ensure safety.
 - Provide protection circuits and protection devices to ensure system safety.
 - Provide of a redundant circuit so that a malfunction does not make the system unsafety.
- (6) When a dogma shall be occurred about safety for this product, be sure to inform us rapidly, operate your technical examination.

2. Precaution for fundamental structure of sensor

Infrared Array Sensor is a thermopile type infrared sensor which detects the amount of infrared rays.

In general, the sensor output may change in the following cases.

Be sure to check the performance and reliability under actual operating conditions, and correct, if necessary, the output under the actual operating conditions.

If the sensor partially changes temperature.

- If there is a heating element (MCU, power supply, etc.) near the sensor.
- If the sensor unit is exposed to warm or cold air.
- If the sensor body is in contact with the housing of the equipment.

If there is an obstacle between the sensor and the target object.

- If there is an object between the sensor and the target object that does not easily transmit far infrared rays, such as glass, acrylic, or steam.
- If a foreign matter (dust, dirt, water drops, etc.) that inhibits transmissions of far-infrared rays is attached to the lens of the sensor body.

3. Use environment

- (1) Temperature: See the specifications
- (2) Humidity: 15 % to 85 % R.H. (Avoid freezing and dew condensation)
- (3) Atmospheric pressure: 86 to 106 kPa
- (4) Vibrations and shocks may damage the sensor, and cause malfunction and performance deterioration. If loads and shocks are applied on the lense, the damaged sensor may cause malfunction and performance deterioration.
- (5) The product is not water/splash-proof. Therefore, take measures against water, dust, condensation, and freezing depending on the operating environment. If water drops adhere to a soldered part, a short circuit will occur due to solder migration. Therefore, take measures to prevent water from leaking.
- (6) Avoid use and storage in the corrosive gas (organic solvent, sulfurous acid and hydrogen sulfide gases) to avoid malfunction and performance deterioration.
- (7) Use surge absorbers as applying the external surge voltage may damage the internal circuit.
- (8) Malfunction may occur near electric noises from static electricity, lightning, broadcast or amateur radio stations and mobile phones.
- (9) The sensor can continuously operate within the range of using ambient temperature (using ambient humidity). However, ensure that humidity is within the range described in the following page as humidity varies according to temperature. Avoid the continuous operation near the operational limit. The temperature range does not guarantee the durability.

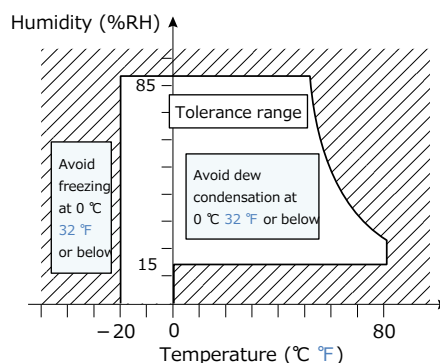

6. About wiring

- (1) Wiring should be done exactly as shown in the terminal connection diagram. In particular, be careful not to connect the power supply in the reverse direction, as this may cause damage or deterioration of the product.
- (2) VPP must be connected to VDD. Failure to do so may cause sensor failure.
- (3) To avoid the effects of noise, it is recommended to use a shielded cable and keep the length of the cable as short as possible.

7. Cleaning

- (1) If the dirt or water droplets is attached to the lens, wipe it with soft cloth. Wiping too strongly may cause the lens to peel off or scratch the surface of the lens, which may result in malfunction.
- (2) Do not use ultrasonic cleaning as it may cause damage such as wire disconnection.

8. Transportation and storage

- (1) Extreme vibration and shock during transport will damage the sensor. Handle the outer box and reel with care.
- (2) Storage under extreme conditions will cause soldering degradation, external appearance defects, and characteristic Recommended conditions of the storage place are below.
 - Temperature : 0 to 45 °C 32 to 113 °F
 - Humidity : Below 70 % R.H.
 - Atmosphere : Low-dust and free from noxious chemicals such as sulfurous acid gas

9. Other handling cautions

- (1) This product may malfunction if dropped on its own before it is installed. Do not use if this happens.
- (2) If the sensor get high frequency vibration, it can be cause of breakdown. When the product get impulse like below, do not use it.
 - Touch to a object made of metal
 - Touch of mutual sensors
- (3) Since static charge can damage the sensor, bear in mind the following handling precautions.
 - Plastic containers should not be used to store or transport the sensors since they readily become charged.
 - Store or transport the product in an environment that hinders the occurrence of static electricity (for example, places with 45% to 60% humidity) and protect the product using electrically conductive packaging.
 - Any personnel handling the sensor should wear electrostatic clothing and be body grounded.
 - Place an electrically conducting board on the work surface and ground any devices used such as measuring instruments and jigs.

10. Special remarks

We will do our utmost to control the quality of this product, but please be aware of the following:

- (1) This product is designed to use in general applications at general electric equipment (Household electric appliances, AV products, office equipment, information and equipment, etc.). This product is not an important safety product. This product is not equipped with fail proof/fault diagnosis functions. Therefore, we are not responsible for any loss or damage to life, body, or property caused by the malfunction of this product, in such unsafe events as described in (a) through (d) below.
 - (a) Fire accident (Fire, smoke)
 - (b) Electrocution (Electric shock)
 - (c) Damages (Fall down/Explosion/Poisoning)
 - (d) Fire/electrocution/damages at life end
- (2) This catalog shows the quality and performance of individual components. Be sure to evaluate and confirm them in the condition in which they are mounted on your products and in the actual operating environment when using the products.
- (3) The warranty period for this product is one year after purchase or delivery to the designated location unless otherwise specified between both parties.

- (4) In the event that we are found to blame for any failures or defects in our products during the warranty period, we will provide replacements or supply the necessary spare parts or replace and/or repair the defective sections free of charge and with all due speed at the location where the products concerned were purchased or delivered. However, the following failures and defects are not covered by the warranty:
- When the failure or defect was caused by a specification, standard, handling method, etc. which was specified by you.
 - When the failure or defect was caused after purchase by you or delivery to your premises by an alteration in construction, performance, specification, etc. which did not involve us.
 - The case that the product condition changed by handling, storage and / or transportation after delivery.
 - When the failure or defect was caused by a phenomenon that could not be predicted by the technology that was being applied in practice either after purchase by you or at the time when the contract was signed.
 - If the product is used outside the range of conditions and environments described in this catalog.
 - When, after our products were incorporated into your products or equipment for use, damage resulted which could have been avoided if your products or equipment had been equipped with the functions, construction, etc. the provision of which is accepted practice in the industry.
 - When the failure or defect was caused by a natural disaster or other force majeure. The terms and conditions of the warranty here set forth apply solely to the warranty of the discrete products which were purchased by you or delivered to your premises, and they do not cover any damage induced by their failure or defects.
- (5) Products and specifications described in this catalog are subject to change (including specification changes and discontinuation) due to product improvements or other reasons. When considering the use of this product for a new product, contact us and confirm that the information described in these specifications is the latest available.
- (6) Have the product you purchased undergo an acceptance inspection as soon as possible, and take sufficient care in the management and maintenance of the product before and during the acceptance inspection.
- (7) As to the disposal of the product, check the method of disposal in each country or region where the product are incorporated in your products to be used.
- (8) The technical information contained in this catalog is intended to provide examples of typical product operation and applicable circuits and does not constitute a guarantee of non-infringement of intellectual property rights or a license to use such information by us or any third party.
do not use it.

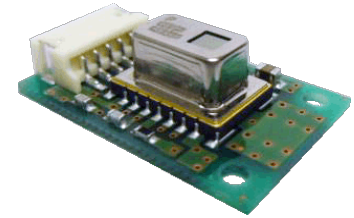

Infrared Array Sensor Grid-EYE

PC Board Mounting

AMG8854M01 (Narrow type)

High precision infrared array sensor based on advanced MEMS technology

Feature

- Temperature detection of two-dimensional area: 8 × 8 (64 pixels)
- Digital output (capability of temperature value output)
- PC board mounting with connector (5 pin)
- RoHS compliance

Recommended applications

- Home appliance (microwaves and air-conditioners)
- Energy saving at office (air conditioning control)
- Home automation (heat source detection)
- Factory automation (Fault prevention)

Ordering information

AMG	8	8	5	4M01			
Code	Vertical pixel	Code	Horizontal pixel	Code	Applied voltage	Code	Product form
8	8 : 8 pixels	8	8 : 8 pixels	5	5.0 V	4M01	PC board mounting

Types

Product name	Number of pixel	Operating voltage	Part number	Tape and reel package (pcs)
Infrared array sensor Grid-EYE Narrow angle type	64 (Vertical 8 × Horizontal 8 Matrix)	5.0 V	AMG8854M01	1000

Rating

Item	Performance
Applied voltage	5.0 V ± 0.5 V
Temperature range of measuring object	-20 °C to 100 °C -4 °F to +212 °F
Operating temperature range	-20 °C to 80 °C -4 °F to +176 °F
Storage temperature range	-20 °C to 80 °C -4 °F to +176 °F

Absolute maximum ratings

Item	Absolute maximum ratings	Terminal
Applied voltage	-0.3 V to 6.5 V	VDD
Input voltage	-0.3 V to VDD +0.3 V	SCL, SDA, AD_SELECT
Output sink current	-10 mA to 10 mA	INT, SDA
Static electricity (Human body model)	1 kV	All terminals
Static electricity (Machine model)	200 V	All terminals

Characteristics

Item	Performance
Temperature accuracy	Typ. $\pm 3.0\text{ }^{\circ}\text{C}$ $\pm 5.4\text{ }^{\circ}\text{F}$
Viewing angle	Typ. 35.6 °
Current consumption	Typ. 4.5 mA (normal mode) Typ. 0.2 mA (sleep mode)
Setup time	Typ. 50 ms (Time to enable communication after setup) 15 s or more (Time to stabilize output after setup)

Performance

Item	Performance
Number of pixel	64 (Vertical 8 × Horizontal 8 Matrix)
External interface	I ² C
Frame rate	Typ. 1 fps or Typ. 10 fps ^{*1}
Operating mode ^{*2}	Normal Sleep
Output mode	Temperature output
Calculate mode	No moving average or Twice moving average
Temperature output resolution	0.25 $^{\circ}\text{C}$ 0.45 $^{\circ}\text{F}$
Number of sensor address	1 (I ² C slave address : 1101 000)
Thermistor output temperature range	-20 $^{\circ}\text{C}$ to 80 $^{\circ}\text{C}$ -4 $^{\circ}\text{F}$ to +176 $^{\circ}\text{F}$
Thermistor output resolution	0.0625 $^{\circ}\text{C}$ 0.1125 $^{\circ}\text{F}$

*1: fps: frame per second

*2: Normal Mode : normal operation mode

Sleep Mode: detection is off (output and data reading not possible)

Internal circuit

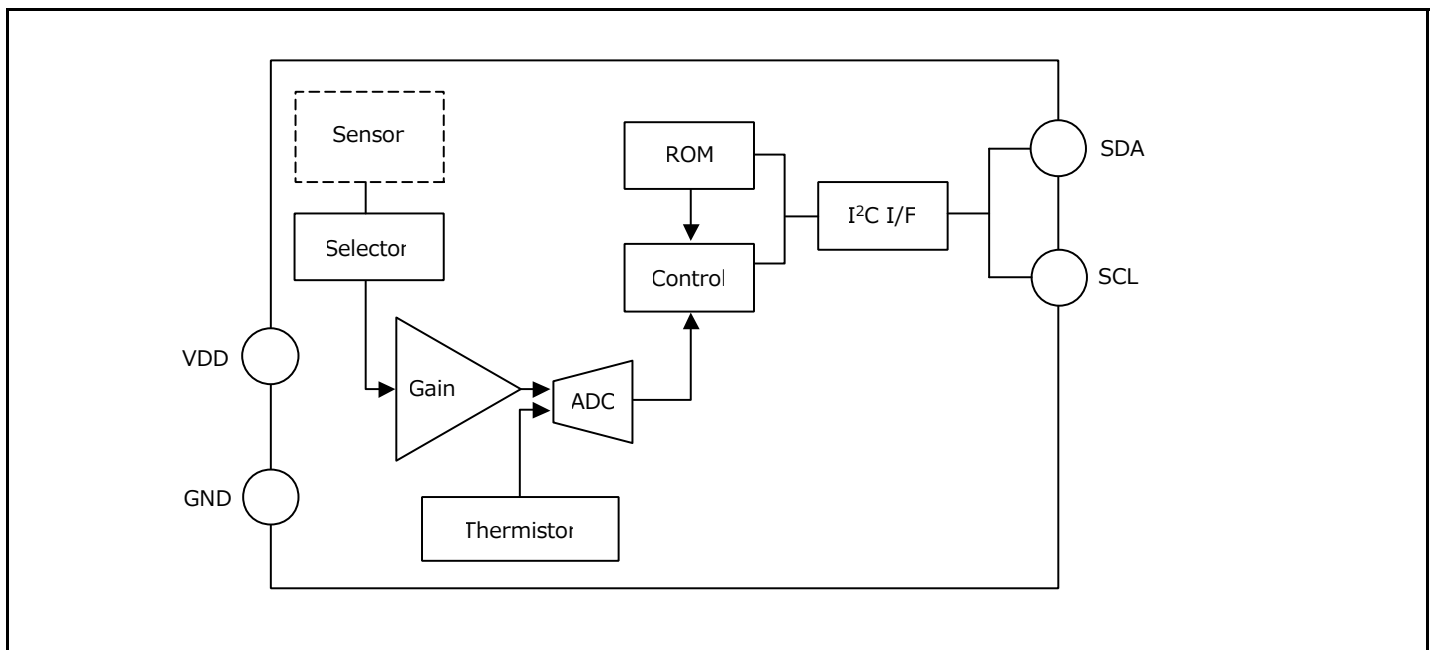

Print board circuit

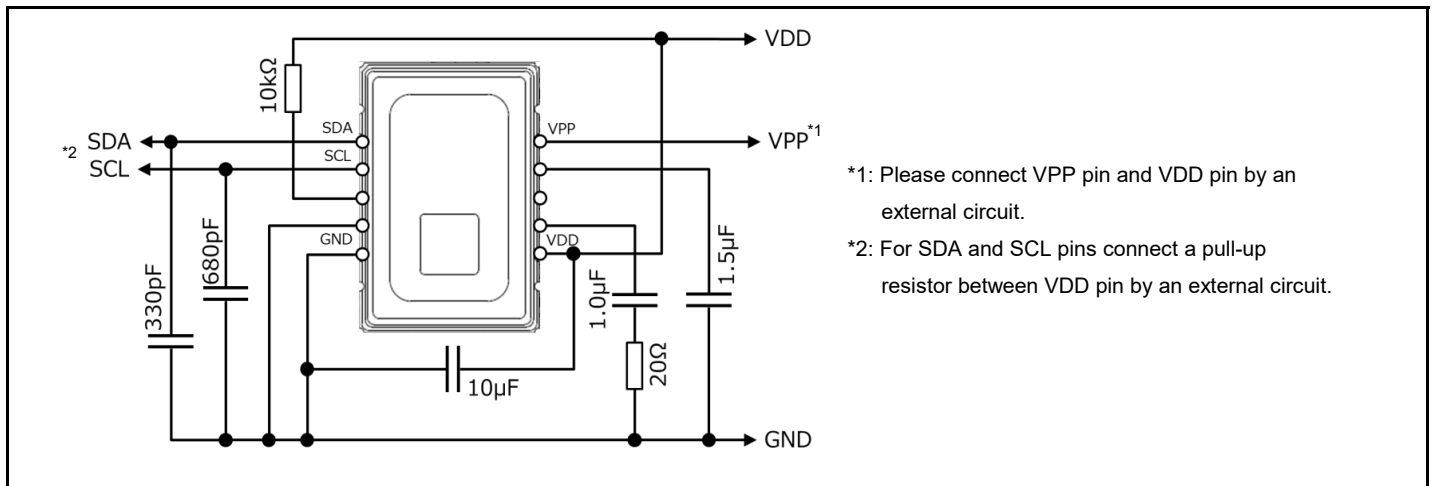

Pixel array and viewing angle

(1) Pixel array

Pixel array from 1 to 64 is shown below.

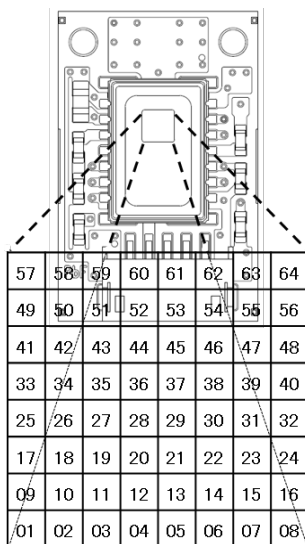

(2) Viewing field

Sensor viewing field (Typ.) is shown below.

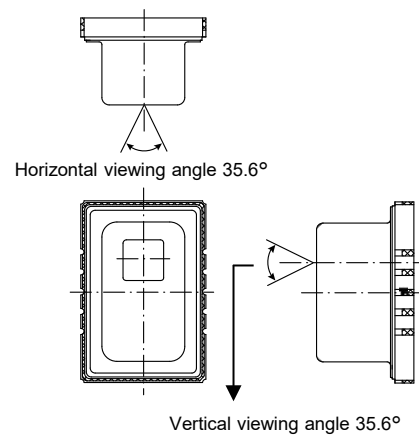

Optical properties

(1) Each pixel's viewing central angle

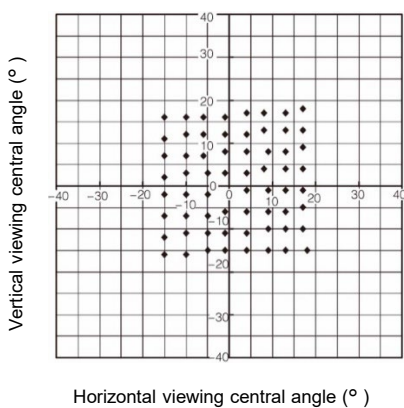

(2) Each pixel's viewing angle (half angle)

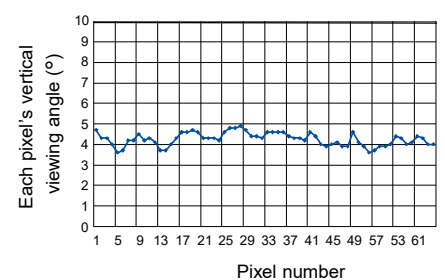
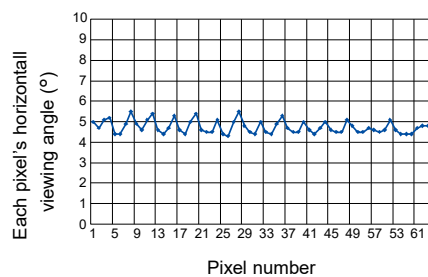

Dimensions

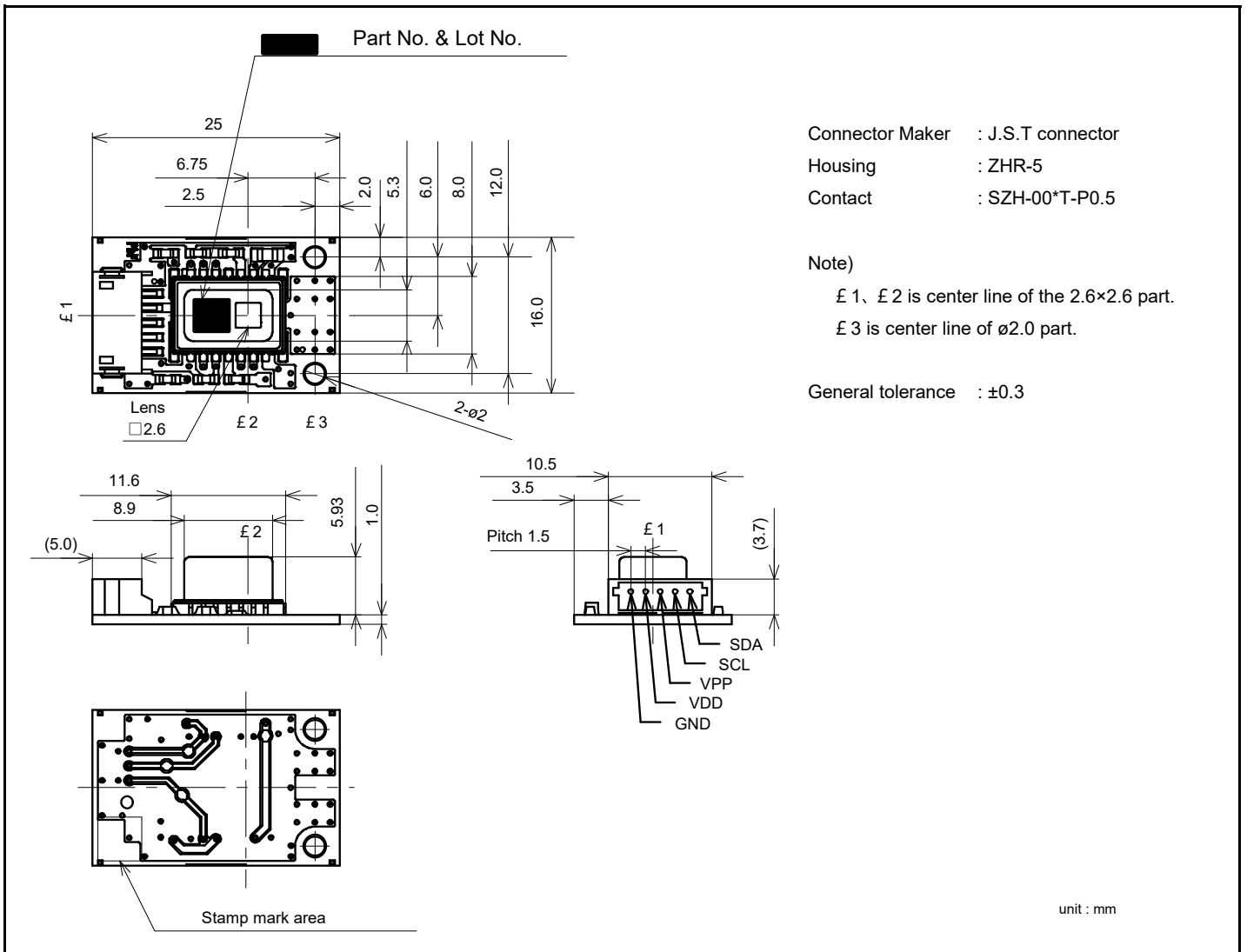

Pressure Sensors

PS-A

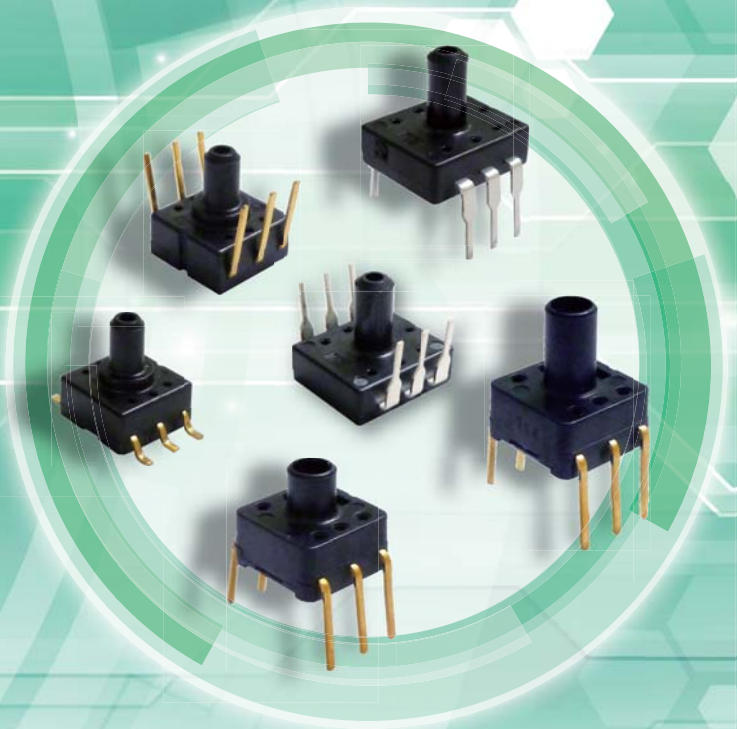

! Application Guidelines (PS-A)

1. Mounting

Use the land of the printed-circuit board on which the sensor is securely fixed.

2. Soldering

Avoid the external thermal influence as the product has a limited thermal capacity due to its compact structure. Heat deformation may damage the sensor or deteriorate its performance. Use the non-corrosive rosin flux. Prevent the flux from entering into the inside of the product as the sensor is exposed to the atmosphere.

(1) Manual soldering

- Raise the temperature of the soldering tip between 260 and 300 °C 500 and 572 °F (30 W) and solder within 5 seconds.
- The sensor output may vary if the load is applied on the terminal during soldering.
- Keep the soldering tip clean.

(2) DIP soldering (DIP Terminal)

- Keep the temperature of the DIP solder tank below 260 °C 500 °F and solder within 5 seconds.
- To avoid heat deformation, do not perform DIP soldering when mounting on the circuit board which has a small thermal capacity.

(3) Reflow soldering (SMD Terminal)

- The recommended reflow temperature profile conditions are given below.

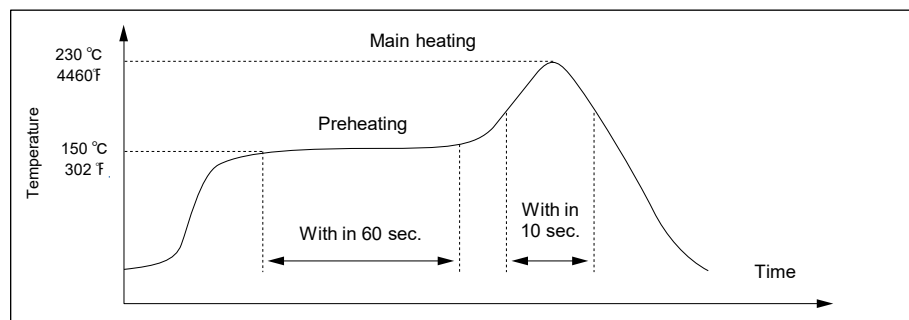

- We recommend the screen solder printing method as the method of cream.
 - Please refer to the recommended PC board specification diagram for the PC board foot pattern.
 - Self alignment may not always work as expected, therefore, please carefully the position of the terminals and pattern.
 - The temperature of the profile is assumed to be a value measured with the printed wiring board of the terminal neighborhood.
 - Please evaluate solderability under the actual mounting conditions since welding and deformation of the pressure inlet port may occur due to heat stress depending on equipments or conditions.
- (4) Rework soldering
- Complete rework at a time.
 - Use a flattened soldering tip when performing rework on the solder bridge. Do not add the flux.
 - Keep the soldering tip below the temperature described in the specifications.
- (5) Avoid drop and rough handling as excessive force may deform the terminal and damage soldering and rough handling as excessive force may deform the terminal and damage soldering
- (6) Keep the circuit board warpage within 0.05 mm of the full width of the sensor.
- (7) After soldering, do not apply stress on the soldered part when cutting or bending the circuit board.
- (8) Prevent human hands or metal pieces from contacting with the sensor terminal.
Such contact may cause anomalous outlets as the terminal is exposed to the atmosphere.
- (9) After soldering, prevent chemical agents from adhering to the sensor when applying coating to avoid insulation deterioration of the circuit board.
- (10) Please consult us concerning leadfree soldering.

3. Wire connection

- (1) Correctly wire as in the connection diagram. Reverse connection may damage the product and degrade the performance.
- (2) Do not use idle terminals to prevent damages to the sensor.

4. Cleaning

- (1) Prevent cleaning liquid from entering the inside of the product as the sensor is exposed to the atmosphere.
- (2) Do not perform ultrasonic cleaning in order to prevent damages to the product.

5. Environment

- (1) Avoid use and storage in the corrosive gas (organic solvent, sulfurous acid and hydrogen sulfide gases) which negatively affects the product.
- (2) Install the capacitor on the power supply terminal of the sensor and stabilize supply voltage to maintain a superimposed noise resistance. Recommended installation is to arrange 0.1 μ F and 1,000 pF in parallel. Before use, check the noise resistance and select/add the optimal capacitor.
- (3) Use surge absorbers as applying the external surge voltage may damage the internal circuit.
- (4) Malfunction may occur near electric noises from static electricity, lightning, broadcast or amateur radio stations and mobile phones
- (5) Avoid use in a place where these products come in contact with water as the sensor does not have a splash proof construction.
- (6) Avoid use in an environment where these products cause dew condensation. When water attached to the sensor chip freezes, the sensor output may be fluctuated or damaged.
- (7) Due to the structure of the pressure sensor chip, the output varies under light. Do not expose the sensor chip to light when applying a voltage by using a transparent tube.
- (8) Do not apply high-frequency oscillation, such as ultrasonic waves, to the product.

6. Quality check under actual use conditions

These specifications are for individual components. Before use, carefully check the performance and quality under actual use conditions to enhance stability.

7. Other precautions

- (1) The wrong mounting method and the pressure range may invite the risk of accidents.
- (2) Only applicable pressure medium is dry air. Avoid use in the corrosive gas (organic solvent, sulfurous acid and hydrogen sulfide gases) or other mediums containing moisture or foreign substances. Such mediums may damage or break the product.
- (3) The pressure sensor chip is located inside the pressure introduction port. Do not insert foreign substances, such as wires, into the port as those substances may damage the chip and close the port. Do not block the atmosphere introduction port.
- (4) Use electric power within the rated power range. Use beyond the range may damage the product.
- (5) Follow below instructions as static electricity may damage the product.
 - For Storage, short the circuit between terminals by using conductive substances or wrap the whole chip with aluminum foil. For storage and transportation, avoid plastic containers which are easily electrified.
 - Before use, connect electrified materials on desk and operators to the ground in order to safely discharge static electricity.
- (6) Carefully select and fix tubes, introduction pipes and products based on the working voltage. Please contact us for any inquires.
- (7) After mounding the pressure sensor, prevent the potting agent from entering the pressure and the atmosphere introduction ports when coating the circuit board. Use the elastic resin as the heated resin may expand, contract and apply pressure to the sensor. After coating, carefully check if the sensor can be used.

Pressure Sensor

PS-A (ADP5) series

(Built-in amplification and temperature compensating circuit)



Built-in amplifier and compensating circuit

Feature

- Built-in amplifier and temperature compensation circuit, no need for circuit design and characteristic adjustment.
- High accuracy and reliability : overall accuracy $\pm 1.25\%$ FS (Standard), $\pm 2.5\%$ FS (Low-pressure type)
- Compact size, space-saving : compatible size for PS type (Standard/Economy, S and M packages)
- RoHS compliant

Typical applications

- Industrial use : Pressure switches and pneumatic components, compressed air pressure measuring devices
 - Medical use : Airbeds
 - Others : Pressure sensing devices for air pressure mediums
- [Low-pressure type]
- Water level detection for domestic appliances : Washing machines and dishwashers
 - Air pressure control : Cleanrooms and smoking rooms



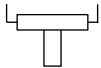
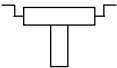

Ordering information

ADP5	1	5	1
Terminal profile	Code	Rated pressure	Code
1 : DIP terminal	0	± 100 kPa	0
	1	-100 kPa	S package length : 3 mm 0.118 inch, dia : 3 mm 0.118 inch
2 : SMD terminal	2	25 kPa	
	4	100 kPa	M package length : 5 mm 0.197 inch, dia : 3 mm 0.118 inch
	5	200 kPa	P package (Only low pressure type) length : 15.6 mm 0.615 inch, dia : 5.45 mm 0.215 inch
	6	500 kPa	
	7	1000 kPa	
	B6	6 kPa (Low pressure type)	

Note : Some part numbers may not be available depending on the combination.
Please refer to the Table of PRODUCT TYPES on the next page.

Product types

Standard packing : Carton : 100 pcs.; Case : 1,000 pcs.

Pressure	Terminal	Package (Pressure inlet hole length)		Part No.				
		Standard type		Standard / Economy type		Low pressure type		
		S package (3 mm 0.118 inch)		M package (5 mm 0.118 inch)		P package (15.6 mm 0.614 inch)		
		DIP terminal 	SMD terminal 	DIP terminal 	SMD terminal 	DIP terminal 		
Standard type (with glass base)								
± 100 kPa		ADP5100	ADP5200	ADP5101	ADP5201			—
-100 kPa		ADP5110	ADP5210	ADP5111	ADP5211			—
25 kPa		ADP5120	—	ADP5121	—			—
100 kPa		ADP5140	ADP5240	ADP5141	ADP5241			—
200 kPa		ADP5150	ADP5250	ADP5151	ADP5251			—
500 kPa		ADP5160	ADP5260	ADP5161	ADP5261			—
1000 kPa		ADP5170	ADP5270	ADP5171	ADP5271			—
Low pressure type								
6 kPa		—	—	—	—			ADP51B63

Rating

● Standard type

Item	Standard type (with glass base)						
Type of pressure	Gauge pressure						
Pressure medium	Air ^{*1}						
Rated pressure (kPa)	±100	-100	25	100	200	500	1000
Max. applied pressure	Twice of the rated pressure						1.5 times the rated pressure
Ambient temperature	-10 °C to +60 °C 14 °F to +140 °F (no freezing or condensation)						
Storage temperature	-20 °C to +85 °C -4 °F to +185 °F (no freezing or condensation)						
Drive voltage	5±0.25 V						
Temperature compensation range	0 °C to 50 °C 32 °F to 122 °F						
Offset voltage ^{*2,3,5}	2.5±0.05						0.5±0.05 V
Rated output voltage ^{*2,3,5}	4.5±0.05 (+when +100kPa)						4.5±0.05 V
Overall accuracy	±1.25 %FS ^{*3,4,5}						
Current consumption	Max. 10 mA ^{*2,3}						

*1: Please consult us for pressure media other than dry air, nitrogen, oxygen, carbon dioxide.

*2: Indicates output when temperature is 25 °C 77 °F.

*3: Indicates output when drive voltage is 5 V. Although output fluctuates due to fluctuations in the drive voltage, this is not included.

*4: Overall accuracy indicates the accuracy of the offset voltage and rated output voltage at a temperature compensation range of 0 to 50 °C 32 to 122 °F.

*5: Accuracy is the value at the time of our shipping. Please set Zero-point calibration function on your products in order to safely use if the offset voltage is shifted.

● Low pressure type

Item	Economy type (without glass base)						
Type of pressure	Gauge pressure						
Pressure medium	Air ^{*1}						
Rated pressure (kPa)	6						
Max. applied pressure	Twice of the rated pressure						
Ambient temperature	0 °C to +70 °C 32 °F to +158 °F (no freezing or condensation)						
Storage temperature	-30 °C to +100 °C -22 °F to +212 °F (no freezing or condensation)						
Drive voltage	5±0.25 V						
Temperature compensation range	0 °C to 70 °C 32 °F to 158 °F						
Offset voltage	0.5 V (Typical) ^{*2}						
Span voltage	4.0 V (Typical) ^{*2}						
Overall accuracy	±2.5 %FS ^{*2,3,4}						
Current consumption	Max. 10 mA						

*1: Please consult us for pressure media other than dry air, nitrogen, oxygen, carbon dioxide.

*2: Indicates output when drive voltage is 5 V. Although output fluctuates due to fluctuations in the drive voltage, this is not included.

*3: Overall accuracy indicates the accuracy of the offset voltage and span voltage at temperatures between 0 to 70 °C 32 to 158 °F (FS=4V)

*4: The initial offset voltage error is not included in the overall accuracy.

Reference data

[Standard type]

1. - ① Output voltage

(Representative example : ADP5170)
 Drive voltage : 5 V
 Temperature : 25 °C 77 °F
 Applied pressure : 0 to +1,000 kPa

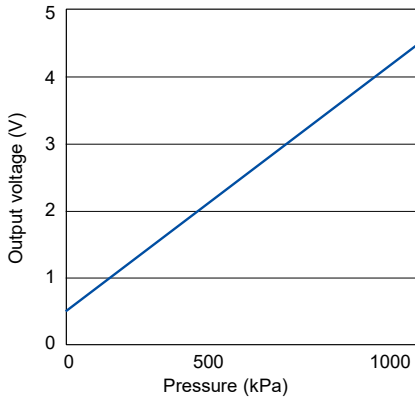

1. - ② Overall accuracy (Offset voltage)

(Representative example : ADP5170)
 Drive voltage : 5 V
 Temperature : 0 to 50 °C 32 to 122 °F
 Applied pressure : 0 kPa

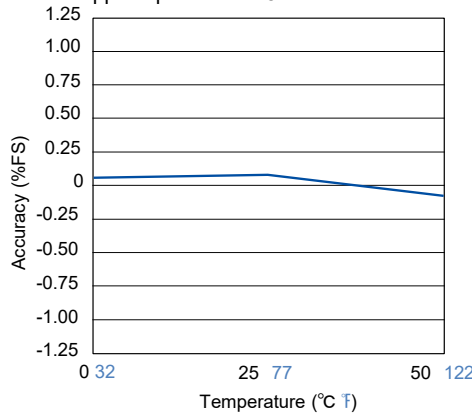

1. - ③ Overall accuracy (Rated output voltage)

(Representative example : ADP5170)
 Drive voltage : 5 V
 Temperature : 0 to 50 °C 32 to 122 °F
 Applied pressure : +1,000 kPa

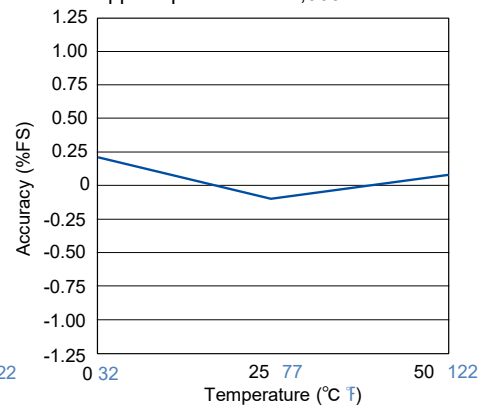

2. - ① Output voltage

(Representative example : ADP5100)
 Drive voltage : 5 V
 Temperature : 25 °C 77 °F
 Applied pressure : -100 to +100 kPa

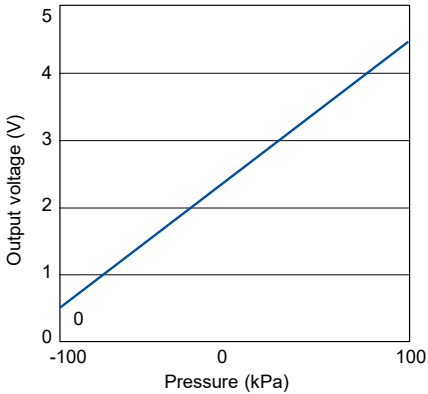

2. - ② Overall accuracy (Offset voltage)

(Representative example : ADP5100)
 Drive voltage : 5 V
 Temperature : 0 to 50 °C 32 to 122 °F
 Applied pressure : 0 kPa

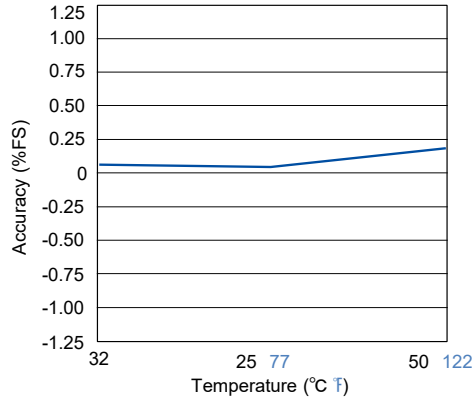

2. - ③ Overall accuracy (Rated output voltage)

(Representative example : ADP5100)
 Drive voltage : 5 V
 Temperature : 0 to 50 °C 32 to 122 °F
 Applied pressure : +100 kPa

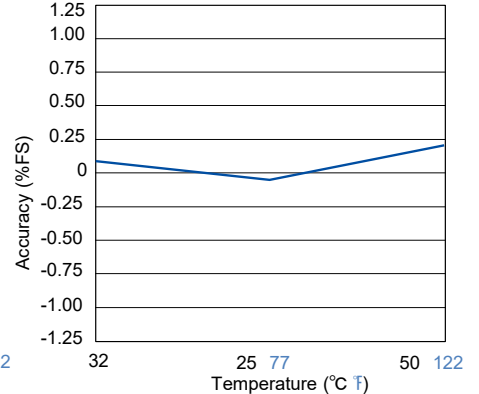

Reference data

[Low pressure type]

1. Output voltage

(ADP51B63)

Drive voltage : 5 V

Temperature : 25 °C 77 °F

Applied pressure : 0 to 6 kPa

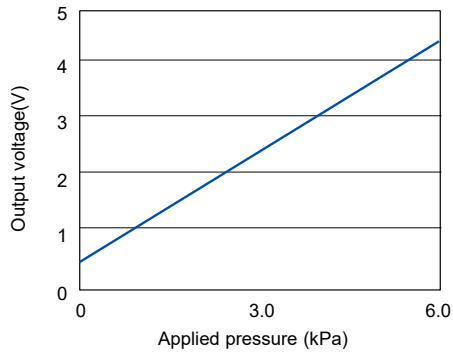

2. THB (high temperature high humidity bias test)

(ADP51B63)

Within 85 °C 185 °F and 85% RH

5 V applied between No.2 (Vdd) and No.3 (GND)

Applied pressure : 0 kPa

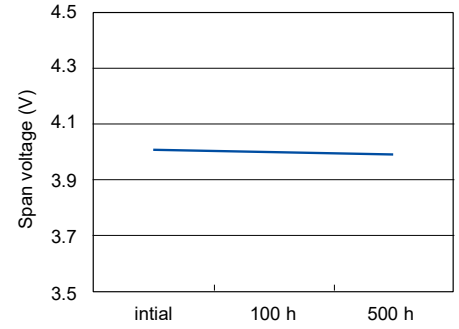
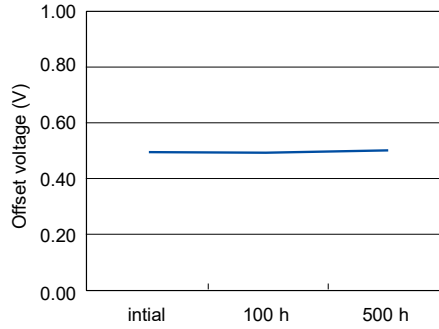

3. Ambient temperature characteristics (ADP51B63)

Ambient temperature : 25 °C 77 °F → 0 °C 32 °F → 10 °C 50 °F → 60 °C 140 °F → 70 °C 158 °F

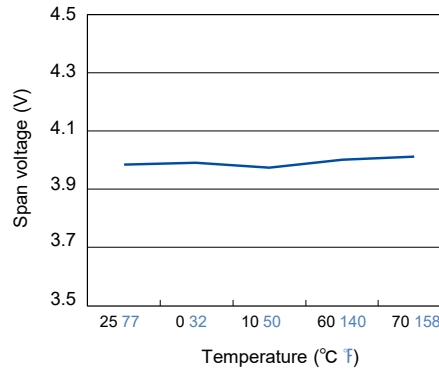
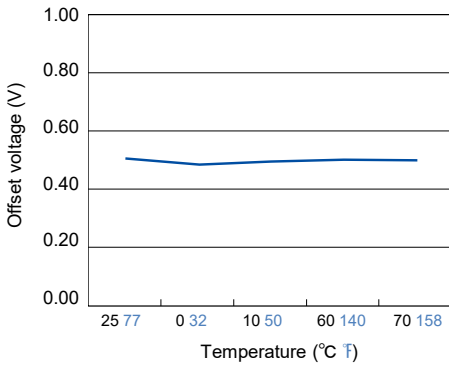

4. Shock test

(ADP51B63)

Shock applied (981 m/s², 3 times in x, y and z directions)

Applied pressure : 0 kPa

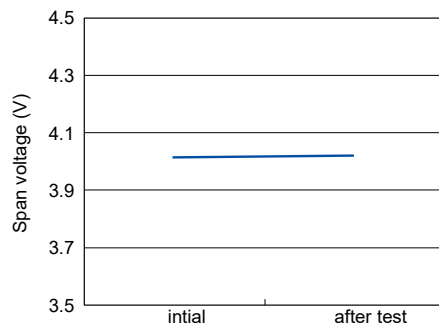
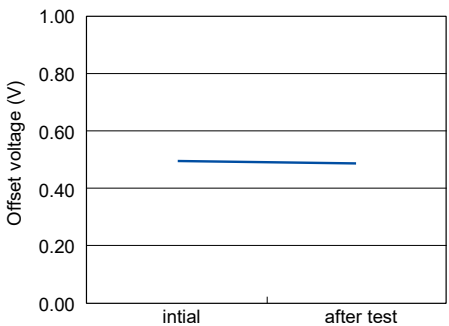

5. Vibration test

(ADP51B63)

Vibration applied (10 to 55 Hz, amplitude : 1.5mm, x, y and z directions, 2 hrs each)

Applied pressure : 0 kPa

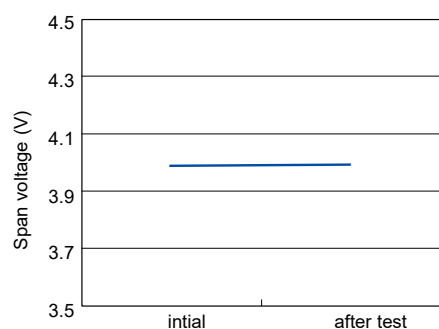
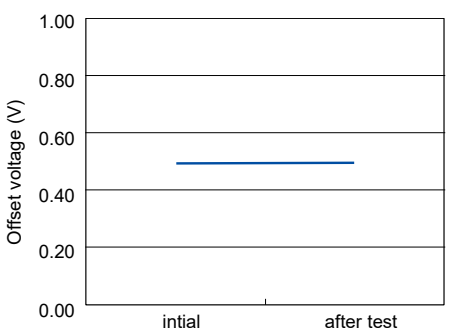

Reference data

6. Temperature/humidity cycle test
(ADP51B63)

Exposed to 10 cycles in the temperature and humidity conditions given below.

Applied pressure : 0 kPa

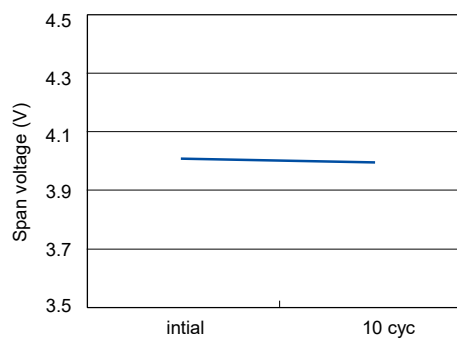
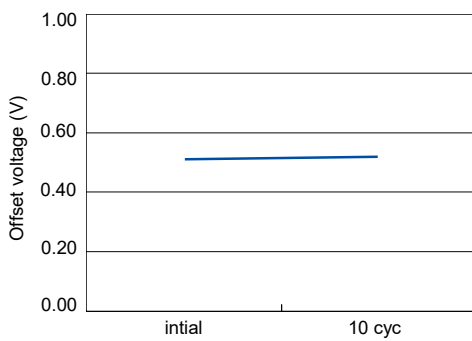
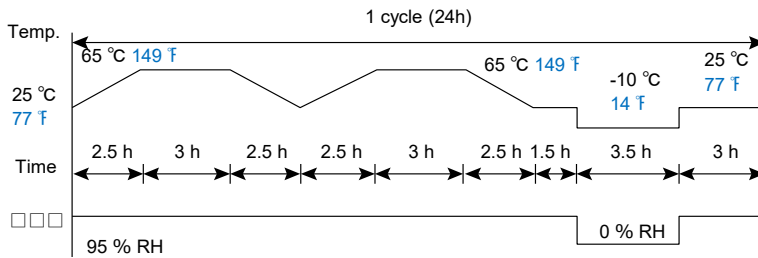

Evaluation test

Classification	Tested item	Tested condition	Result
Environmental characteristics	Storage at high temperature	Temperature : Left in a 85 °C 185 °F constant temperature bath Time : 100 hrs	Passed
	Storage at low temperature	Temperature : Left in a -20 °C -4 °F constant temperature bath Time : 100 hrs	Passed
	Humidity	Temperature/humidity : Left at 40 °C 104 °F, 90 % RH Time : 100 時間	Passed
	Temperature cycle	Temperature : -20 °C to 85 °C -4 °F to 185 °F 1 cycle : 30 min Times of cycle : 100 cycle	Passed
Endurance characteristics	High temperature/high humidity operation	Temperature/humidity : 40 °C 104 °F, 90% RH Operation times : 10 ⁶ , rated voltage applied	Passed
Mechanical characteristics	Vibration resistance	Double amplitude : 1.5 mm 0.059 inch Vibration : 10 to 55 Hz Applied vibration direction : X, Y, Z 3 directions Time : 2 hrs each	Passed
	Dropping resistance	Dropping height : 75 cm 29.528 inch Times : 2 times	Passed
	Terminal strength	Pulling strength : 9.8 N {1 kgf}, 10 sec Bending strength : 4.9 N {0.5 kgf}, left and right 90 ° 1 time	Passed
Soldering characteristics	Solderability	Temperature : 230 °C 446 °F Time : 5 sec	Passed
	Heat resistance (DIP)	Temperature : 260 °C 500 °F Time : 10 sec	Passed

Note: For details other than listed above, please consult us.

Items	Criteria
Offset voltage	Variation amount
Output span voltage	within ±2.5 %FS of value

Dimensions

The CAD data of the products with a **CAD data** mark can be downloaded from: <http://industrial.panasonic.com/>

- Standard type S package (Terminal direction : DIP terminal Pressure inlet hole length : 3 mm 0.118 inch) ADP51□0

CAD data

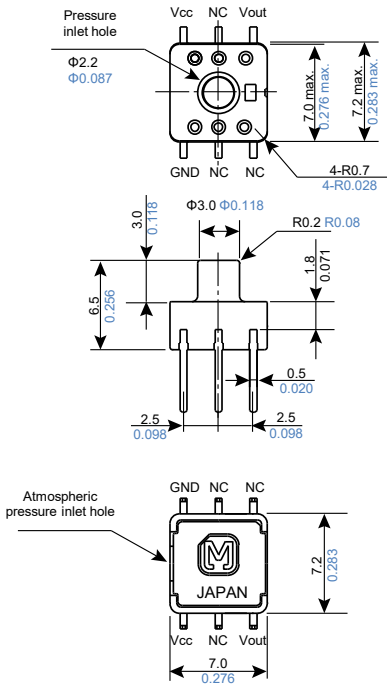

Recommended PC board pattern (TOP VIEW)

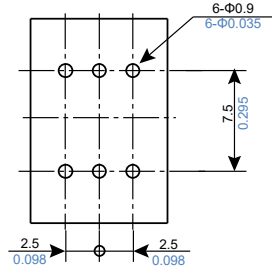

Terminal connection diagram

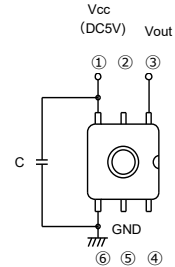

Terminal No.	Name
1	Vcc (Power supply ⊕)
2	NC (No connection)
3	Vout (Output)
4	NC (No connection)
5	NC (No connection)
6	GND (Ground)

Note: leave terminal "No connection" unconnected.

Unit : mm inch, General tolerance $\pm 0.3 \pm 0.012$

- Standard type S package (Terminal direction : SMD terminal Pressure inlet hole length : 3 mm 0.118 inch) ADP52□0

CAD data

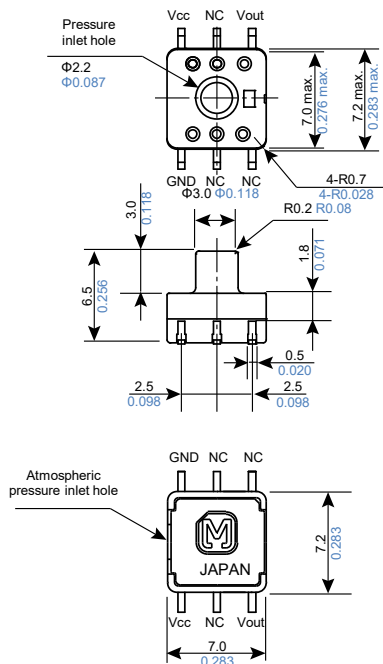

Recommended PC board pattern (TOP VIEW)

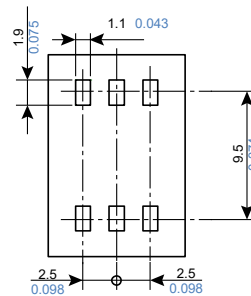

Terminal connection diagram

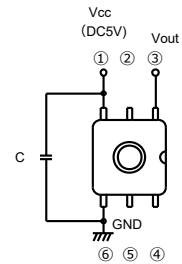

Terminal No.	Name
1	Vcc (Power supply ⊕)
2	NC (No connection)
3	Vout (Output)
4	NC (No connection)
5	NC (No connection)
6	GND (Ground)

Note: leave terminal "No connection" unconnected.

Unit : mm inch, General tolerance $\pm 0.3 \pm 0.012$

Dimensions

The CAD data of the products with a **CAD data** mark can be downloaded from: <http://industrial.panasonic.com/>

- Standard/Economy type M package (Terminal direction : DIP terminal Pressure inlet hole length : 5 mm 0.197 inch) ADP51□1

ADP51□1/ADP51A11

CAD data

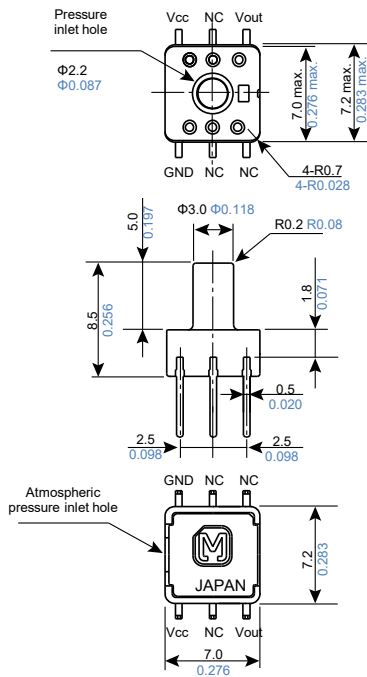

Recommended PC board pattern (TOP VIEW)

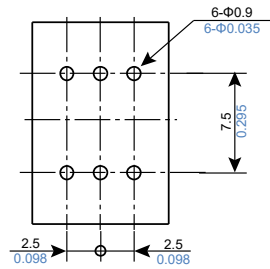

Terminal connection diagram

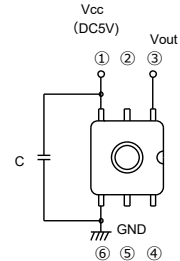

Terminal No.	Name
1	Vcc (Power supply ⊕)
2	NC (No connection)
3	Vout (Output)
4	NC (No connection)
5	NC (No connection)
6	GND (Ground)

Note: leave terminal "No connection" unconnected.

Unit : mm inch, General tolerance $\pm 0.3 \pm 0.012$

- Standard/Economy type M package (Terminal direction : SMD terminal Pressure inlet hole length : 5 mm 0.197 inch) ADP52□1

CAD data

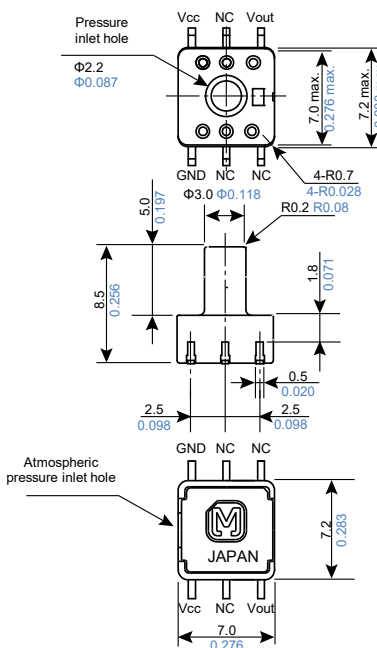

Recommended PC board pattern (TOP VIEW)

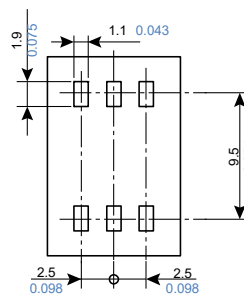

Terminal connection diagram

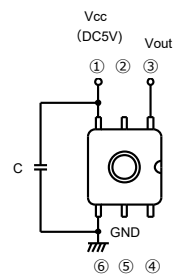

Terminal No.	Name
1	Vcc (Power supply ⊕)
2	NC (No connection)
3	Vout (Output)
4	NC (No connection)
5	NC (No connection)
6	GND (Ground)

Note: leave terminal "No connection" unconnected.

Unit : mm inch, General tolerance $\pm 0.3 \pm 0.012$

Dimensions

The CAD data of the products with a **CAD data** mark can be downloaded from: <http://industrial.panasonic.com/>

- Low pressure type P package (Terminal direction : DIP terminal, Pressure inlet hole length : 15.6 mm 0.614 inch) ADP51B63

CAD data

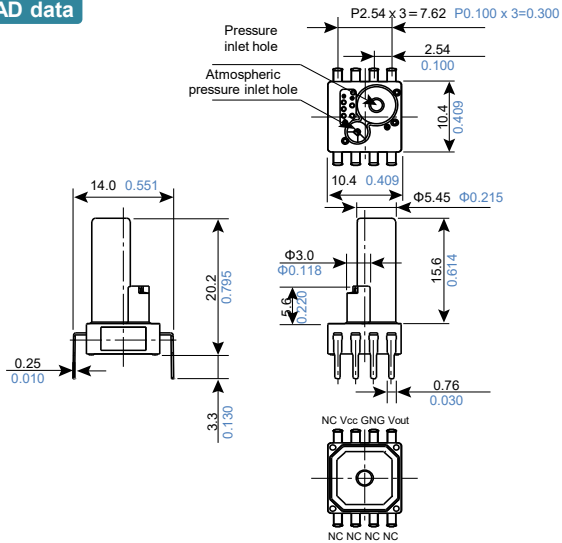

Recommended PC board pattern (BOTTOM VIEW)

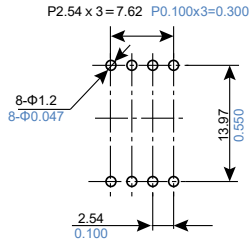

Terminal connection diagram

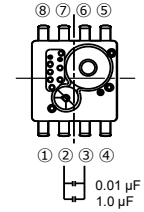

Unit : mm inch, General tolerance ±0.3 ±0.012

Terminal No.	Name
1	NC (No connection)
2	Vcc (Power supply [Ⓢ])
3	GND (Ground)
4	Vout (Output)

Terminal No.	Name
5	NC (No connection)
6	NC (No connection)
7	NC (No connection)
8	NC (No connection)

Note: leave terminal "No connection" unconnected.

Pressure Sensors

PS / PF

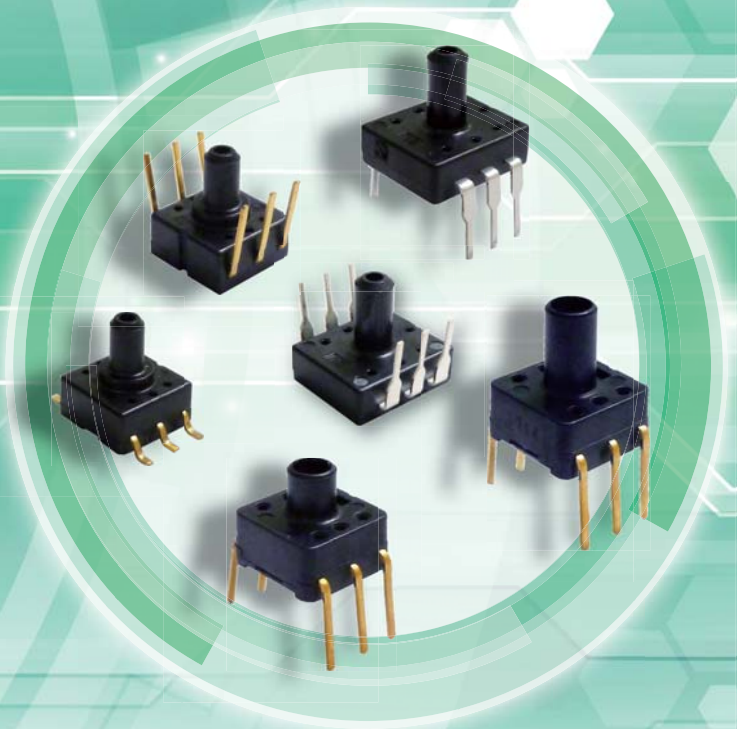

⚠ Application Guidelines (PS, PF)

1. Mounting

Use the land of the printed-circuit board on which the sensor is securely fixed.

2. Soldering

Avoid the external thermal influence as the product has a limited thermal capacity due to its compact structure. Heat deformation may damage the sensor or deteriorate its performance. Use the non-corrosive rosin flux. Prevent the flux from entering into the inside of the product as the sensor is exposed to the atmosphere.

(1) Manual soldering

- Raise the temperature of the soldering tip between 260 and 300 °C 500 and 572 °F (30 W) and solder within 5 seconds.
- The sensor output may vary if the load is applied on the terminal during soldering.
- Keep the soldering tip clean.

(2) DIP soldering (DIP Terminal)

- Keep the temperature of the DIP solder tank below 260 °C 500 °F and solder within 5 seconds.
- To avoid heat deformation, do not perform DIP soldering when mounting on the circuit board which has a small thermal capacity.

(3) Reflow soldering (SMD Terminal)

- The recommended reflow temperature profile conditions are given below.

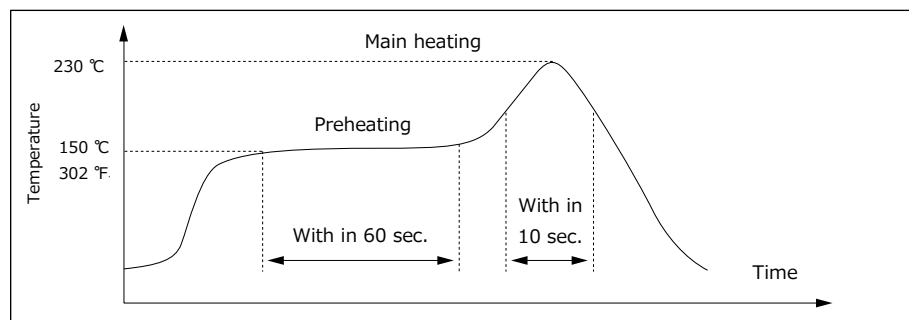

- We recommend the screen solder printing method as the method of cream.
 - Please refer to the recommended PC board specification diagram for the PC board foot pattern.
 - Self alignment may not always work as expected, therefore, please carefully the position of the terminals and pattern.
 - The temperature of the profile is assumed to be a value measured with the printed wiring board of the terminal neighborhood.
 - Please evaluate solderability under the actual mounting conditions since welding and deformation of the pressure inlet port may occur due to heat stress depending on equipments or conditions.
- (4) Rework soldering
- Complete rework at a time.
 - Use a flattened soldering tip when performing rework on the solder bridge. Do not add the flux.
 - Keep the soldering tip below the temperature described in the specifications.
- (5) Avoid drop and rough handling as excessive force may deform the terminal and damage soldering
- (6) Keep the circuit board warpage within 0.05 mm of the full width of the sensor.
- (7) After soldering, do not apply stress on the soldered part when cutting or bending the circuit board.
- (8) Prevent human hands or metal pieces from contacting with the sensor terminal.
Such contact may cause anomalous outlets as the terminal is exposed to the atmosphere.
- (9) After soldering, prevent chemical agents from adhering to the sensor when applying coating to avoid insulation deterioration of the circuit board.
- (10) Please consult us concerning leadfree soldering.

3. Cleaning

- (1) Prevent cleaning liquid from entering the inside of the product as the sensor is exposed to the atmosphere.
- (2) Do not perform ultrasonic cleaning in order to prevent damages to the product.

4. Environment

- (1) Avoid use and storage in the corrosive gas (organic solvent, sulfurous acid and hydrogen sulfide gases) which negatively affects the product.
- (2) Avoid use in a place where these products come in contact with water as the sensor does not have a splashproof construction.
- (3) Avoid use in an environment where these products cause dew condensation.
When water attached to the sensor chip freezes, the sensor output may be fluctuated or damaged.
- (4) Due to the structure of the pressure sensor chip, the output varies under light.
Do not expose the sensor chip to light when applying a voltage by using a transparent tube.
- (5) Do not apply high-frequency oscillation, such as ultrasonic waves, to the product.

5. Quality check under actual use conditions

These specifications are for individual components. Before use, carefully check the performance and quality under actual use conditions to enhance stability.

6. Other precautions

- (1) The wrong mounting method and the pressure range may invite the risk of accidents.
- (2) Only applicable pressure medium is dry air. Avoid use in the corrosive gas (organic solvent, sulfurous acid and hydrogen sulfide gases) or other mediums containing moisture or foreign substances. Such mediums may damage or break the product.
- (3) The pressure sensor chip is located inside the pressure introduction port. Do not insert foreign substances, such as wires, into the port as those substances may damage the chip and close the port. Do not block the atmosphere introduction port.
- (4) Use electric power within the rated power range. Use beyond the range may damage the product.
- (5) Follow below instructions as static electricity may damage the product.
 - For Storage, short the circuit between terminals by using conductive substances or wrap the whole chip with aluminum foil. For storage and transportation, avoid plastic containers which are easily electrified.
 - Before use, connect electrified materials on desk and operators to the ground in order to safely discharge static electricity.
- (6) Carefully select and fix tubes, introduction pipes and products based on the working voltage. Please contact us for any inquiries.

7. Application circuit diagram (Example)

The pressure sensor converts a voltage by constant current drive and if necessary, amplifies the voltage.

The circuit on the right is a typical use example.

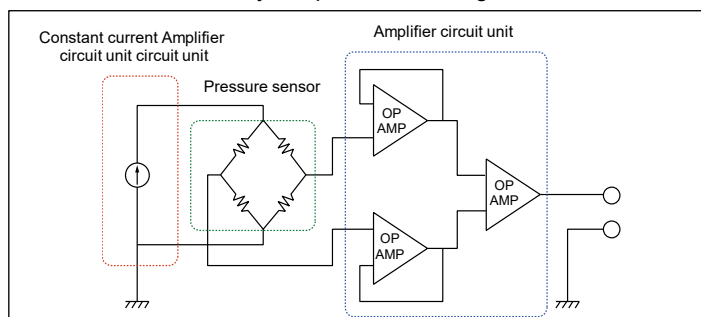

8. Mounting method

The general method of air pressure transmission varies depending on the low/high pressure condition.

● Usage note

- ① Select a sturdy pressure introduction pipe to avoid pressure leak.
- ② Securely fix the pressure introduction pipe to avoid pressure leak.
- ③ Do not block the pressure introduction pipe.

Methods of transmitting air pressures

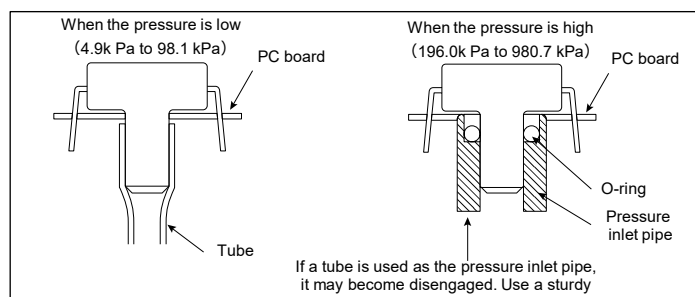

Pressure Sensor

PS (ADP4) series

PF (ADP1) series

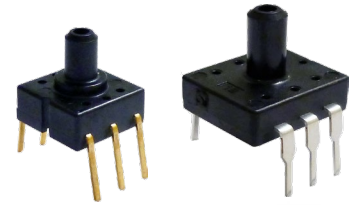

High precision pressure sensor (without amp.)

Feature

- Compact size (PS type)
- High accuracy and liner characteristic
- Broad line-up
- RoHS compliant

Typical applications

- Industrial use : Pressure switches and pneumatic components, compressed air pressure measuring devices and airbeds
- Medical use : Airbeds
- Others : Pressure sensing devices for air pressure mediums

Ordering information

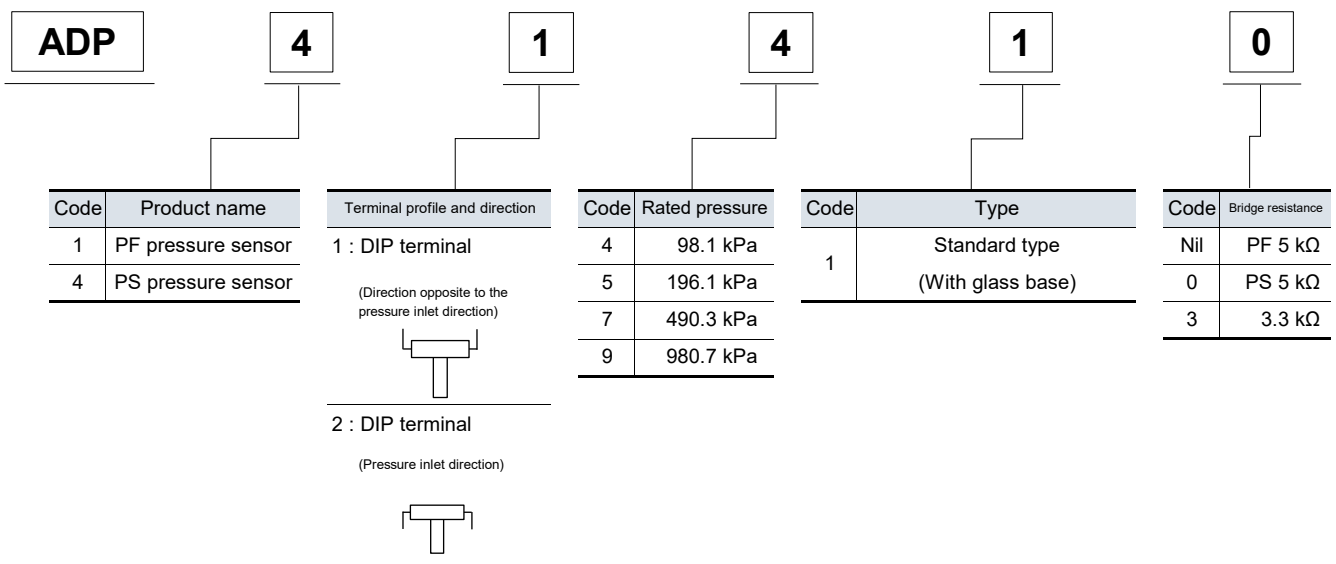

Product types

Standard packing : Carton : 100 pcs.; Case : 1,000 pcs.

Brige resistance		Part No.						
		PS pressure sensor				PF pressure sensor		
		5 kΩ		3.3 kΩ		5 kΩ		
Pressure	Terminal							
		DIP terminal: Direction opposite to the pressure inlet direction	DIP terminal: Pressure inlet direction	SMD terminal	DIP terminal: Direction opposite to the pressure inlet direction	DIP terminal: Pressure inlet direction	DIP terminal: Direction opposite to the pressure inlet direction	DIP terminal: Pressure inlet direction
Standard type (with glass base)								
98.1 kPa		ADP41410	ADP42410	ADP4932	ADP41413	ADP42413	ADP1141	ADP1241
196.1 kPa		ADP41510	ADP42510	—	—	—	ADP1151	ADP1251
490.3 kPa		ADP41710	ADP42710	—	—	—	ADP1171	ADP1271
980.7 kPa		ADP41910	ADP42910	ADP4933	ADP41913	ADP42913	ADP1191	ADP1291

Rating

Type	Standard type (With glass base)				
Type of pressure	Gauge pressure				
Pressure medium	Air ^{*1}				
Rated pressure (kPa)	98.1, 196.1	490.3	980.7	98.1 ^{*2}	980.7 ^{*2}
Max. applied pressure	Twice of the rated pressure		1.5 times of the rated pressure	Twice of the rated pressure	1.5 times of the rated pressure
Bridge resistance	5,000 Ω ± 1,000 Ω			3,300 Ω ± 700 Ω	
Ambient temperature	-20 °C to +100 °C -4 °F to +212 °F (no freezing or condensation)				
Storage temperature	-40 °C to +120 °C -40 °F to +248 °F (no freezing or condensation)				
Standard temperature	25 °C 77 °F			30 °C 86 °F	
Temperature compensation range	0 °C to 50 °C 32 °F to +122 °F			0 °C to 60 °C 32 °F to +140 °F	
Drive current (constant current)	1.5 mA			1.0 mA	
Output span voltage	100 ± 40 mV			65 ± 25 mV	
Offset voltage	±20 mV				
Linearity	±0.3 %FS	±0.5 %FS	±0.6 %FS	±1.0 %FS	
Pressure hysteresis	±0.2 %FS	±0.4 %FS			±1.0 %FS
Offset voltage-temperature characteristics ^{*3}	±5.0 %FS			±3.5 %FS	
Sensitivity-temperature characteristics ^{*3}	±2.5 %FS				

*1: Please consult us for pressure media other than dry air, nitrogen, oxygen, carbon dioxide.

*2: For PS pressure sensor only

*3: This is the regulation which applies within the compensation temperature range.

◆ Unless otherwise specified, measurements were taken with a drive current of ±0.01 mA and humidity ranging from 25% to 85%.

◆ Please consult us if the intended use involves a negative pressure.

Reference data

[PS pressure sensor]

● Characteristics data

1.-(1) Output characteristics

(Representative example : ADP41913)

Drive current : 1.0 mA

Temperature : 30 °C 86 °F

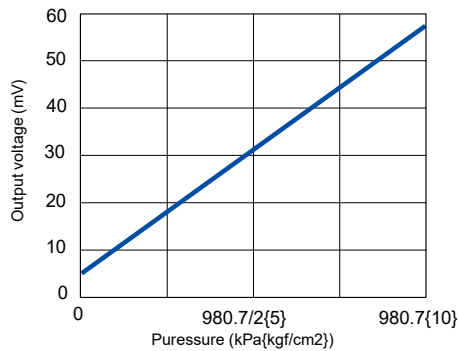

1.-(2) Offset voltage - temperature characteristics

(Representative example : ADP41913)

Drive current : 1.0 mA

Rating : ±3.5 % FS

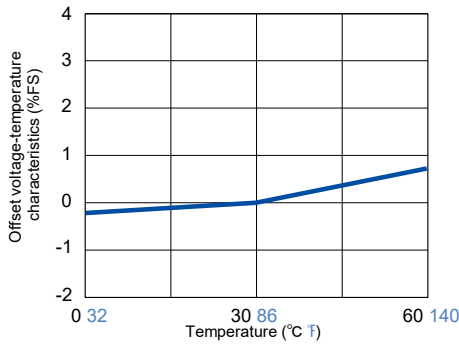

1.-(3) Sensitivity -temperature characteristics

(Representative example : ADP41913)

Drive current : 1.0 mA

Rating : ±2.5 % FS

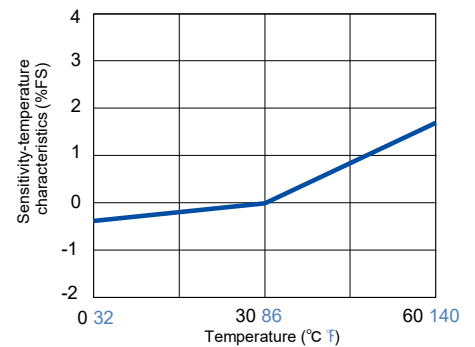

● Pressure cycle range (0 to rated pressure)

(Representative example : ADP41913)

Temperature : 100 °C 212 °F, No. of cycle: 1 × 10⁶

Offset voltage range

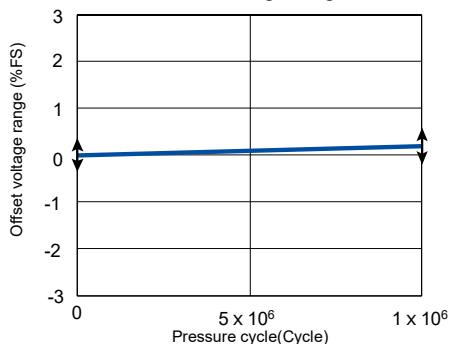

(Representative example : ADP41913 Even after testing for 1 million times,

the variations in the offset voltage and output span voltage are minimal.

Output span voltage range

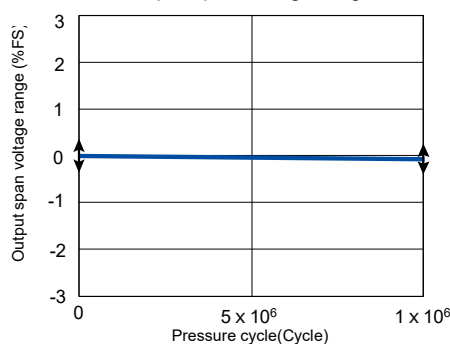

Reference data

[PF pressure sensor]

● Characteristics data

1. - ① Output characteristics

(Representative example : ADP1141)

Drive current : 1.5 mA

Temp. : 25 °C 77 °F

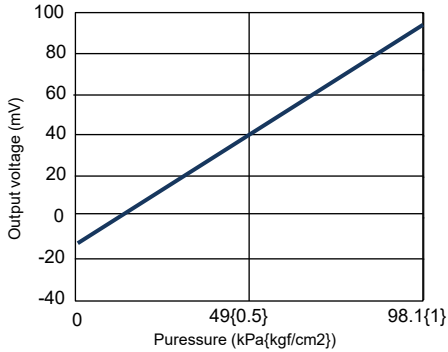

1. - ② Offset voltage - temperature characteristics

(Representative example : ADP1141)

Drive current : 1.5 mA

Rating : ±5 % FS

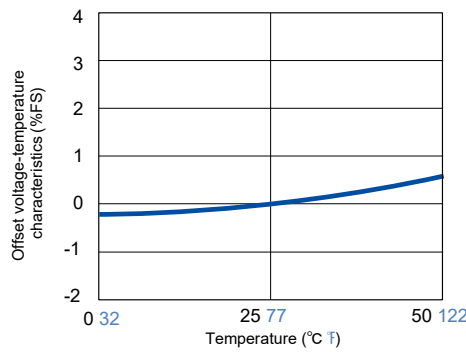

1. - ③ Sensitivity - temperature characteristics

(Representative example : ADP1141)

Drive current : 1.5 mA

Rating : ±2.5% FS

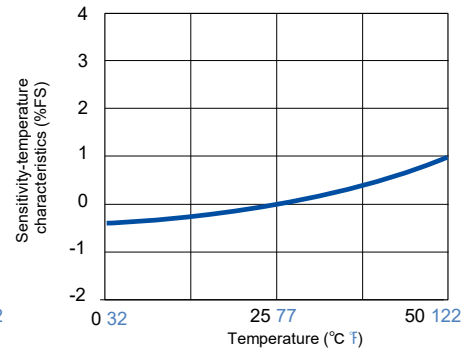

● Pressure cycle range (0 to rated pressure)

(Representative example : ADP1141)

Temperature : 25 °C 77 °F

Offset voltage range

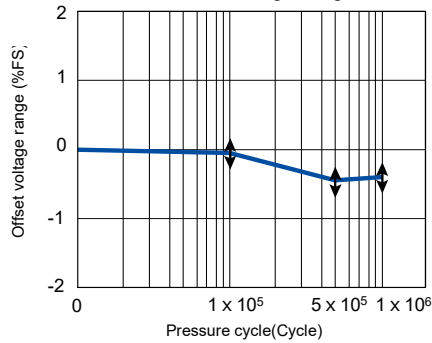

(Representative example : ADP1141)

Output span voltage range

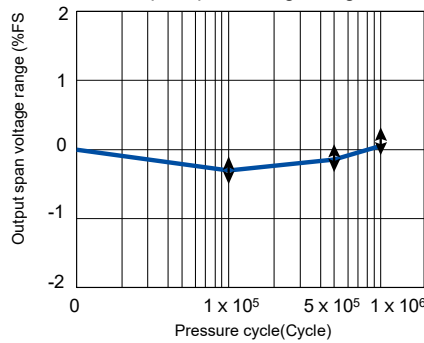

Even after testing for 1 million times, the variations in the offset voltage and output span voltage are minimal.

Evaluation test

Classification	Tested item	Tested condition	Result
Environmental characteristics	Storage at high temperature	Temperature : Left in a 120 °C 248 °F constant temperature bath Time : 1000 h	Passed
	Storage at low temperature	Temperature : Left in a -40 °C -40 °F constant temperature bath Time : 1000 h	Passed
	Humidity	Temperature/humidity : Left at 40 °C 104 °F, 90 % RH Time : 1000 h	Passed
	Temperature cycle	Temperature : -40 °C to 120 °C -40 °F to 248 °F 1 cycle : 30 Min. Times of cycle : 100	Passed
Endurance characteristics	High temperature/ high humidity operation	Temperature/humidity : 40 °C 104 °F, 90% RH Operation times : 10 ⁶ , rated voltage applied.	Passed
Mechanical characteristics	Vibration resistance	Double amplitude : 1.5 mm 0.059 inch Vibration : 10 ~ 55 Hz Applied vibration direction : X, Y, Z 3 directions Time : 2 hrs each	Passed
	Dropping resistance	Dropping height : 75 cm Times : 2 times	Passed
	Terminal strength	Pulling strength : 9.8 N {1 kgf}, 10 sec. Bending strength : 4.9 N {0.5 kgf}, left and right 90 ° 1 time	Passed
Soldering characteristics	Solderability	Temperature : 230 °C 446 °F Time : 5 sec	Passed
	Heat resistance (DIP)	Temperature : 260 °C 500 °F Time : 10 sec	Passed

Note: For details other than listed above, please consult us.

Items	Criteria
Offset voltage	Variation amount
Output span voltage	within ±5.0 %FS of value

Dimensions

The CAD data of the products with a **CAD data** mark can be downloaded from: <http://industrial.panasonic.com/>

[PS pressure sensor]

● Terminal direction : DIP terminal Direction opposite to the pressure inlet direction ADP41□□□

CAD data

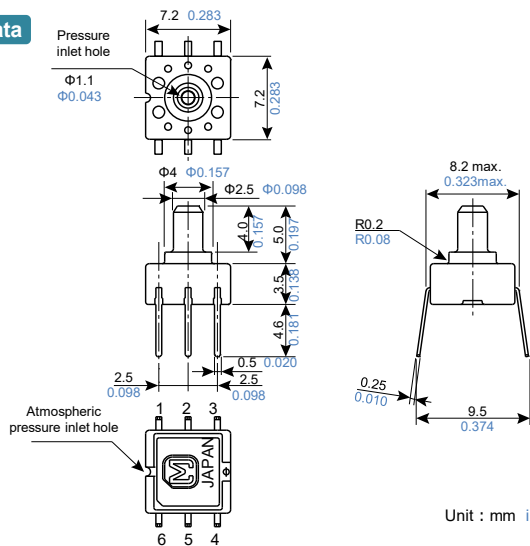

Recommended PC board pattern (BOTTOM VIEW)

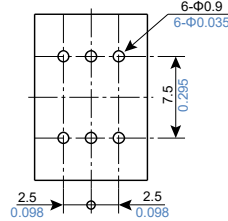

Terminal connection diagram

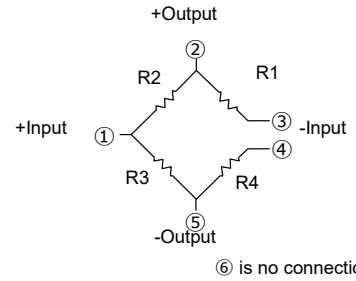

Terminal No.	Name
1	Power supply (+)
2	Output (+)
3	Power supply (-)
4	Power supply (-)
5	Output (-)
6	NC (No connection)

Note: Leave terminal 6 unconnected.

● Terminal direction : DIP terminal Pressure inlet direction ADP42□□□

CAD data

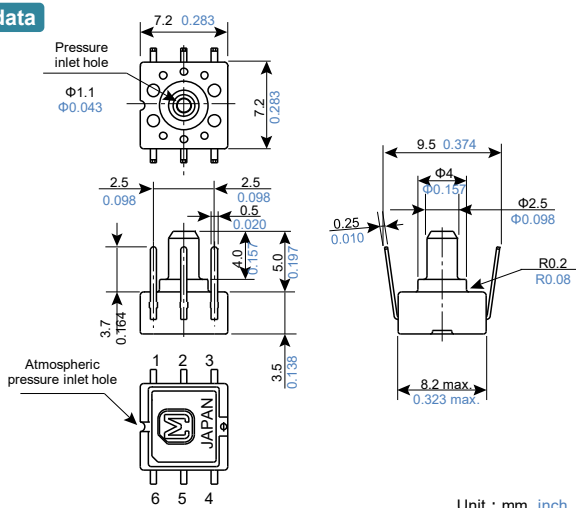

Recommended PC board pattern (BOTTOM VIEW)

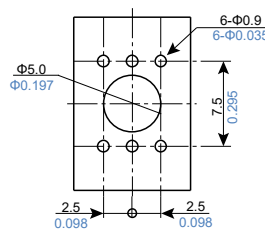

Terminal connection diagram

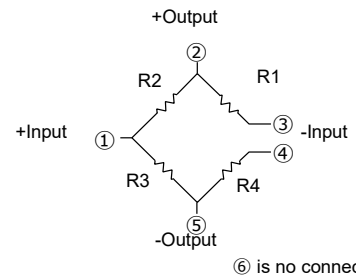

Terminal No.	Name
1	Power supply (+)
2	Output (+)
3	Power supply (-)
4	Power supply (-)
5	Output (-)
6	NC (No connection)

Note: Leave terminal 6 unconnected.

● Terminal direction : SMD terminal ADP4932, ADP4933

CAD data

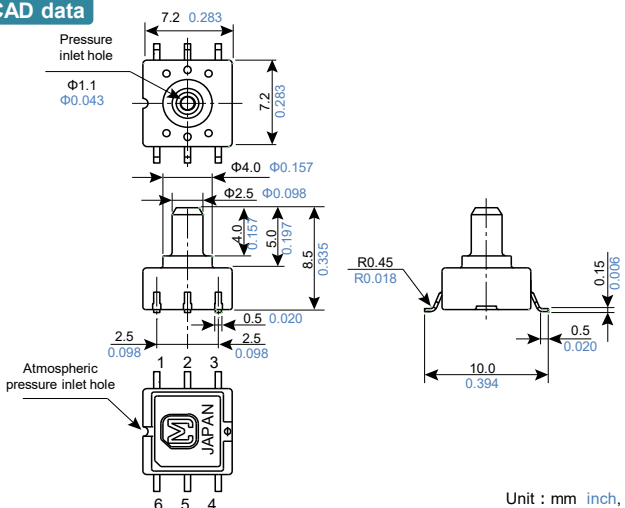

Recommended PC board pattern (BOTTOM VIEW)

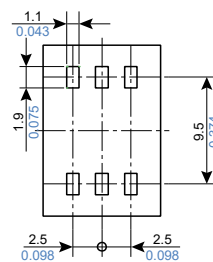

Terminal connection diagram

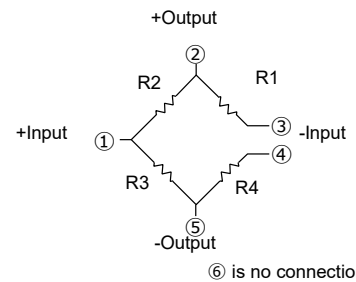

Terminal No.	Name
1	Power supply (+)
2	Output (+)
3	Power supply (-)
4	Power supply (-)
5	Output (-)
6	NC (No connection)

Note: Leave terminal 6 unconnected.

Dimensions

The CAD data of the products with a **CAD data** mark can be downloaded from: <http://industrial.panasonic.com/>

[PF pressure sensor]

● Terminal direction : DIP terminal Direction opposite to the pressure inlet direction ADP11□□

CAD data

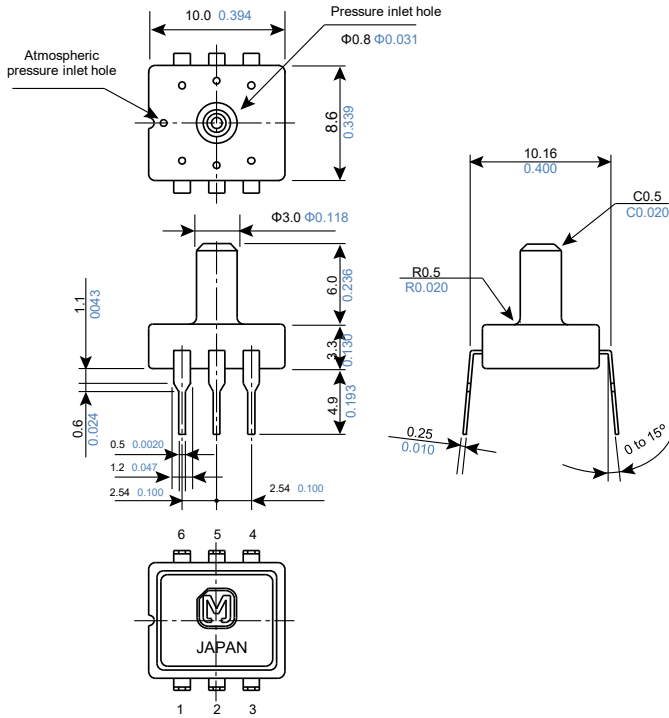

Recommended PC board pattern (BOTTOM VIEW)

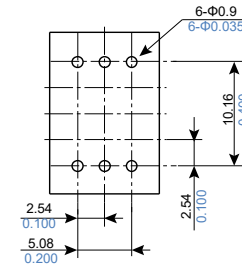

Terminal connection diagram

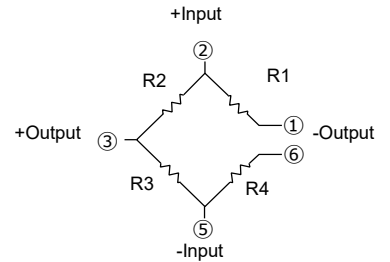

Terminal No.	Name
1	-Output (-)
2	Power supply (+)
3	+Output (+)
4	No connection
5	Power supply (-)
6	-Output (-)

Note: Leave terminal 4 unconnected.

unit : mm inch, General tolerance : ±0.3 ±0.012

● Terminal direction : DIP terminal Pressure inlet direction ADP12□□

CAD data

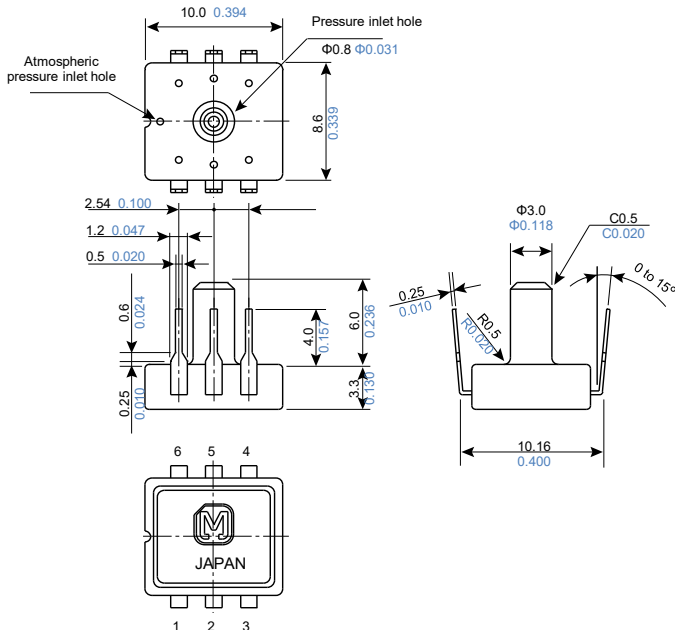

Recommended PC board pattern (BOTTOM VIEW)

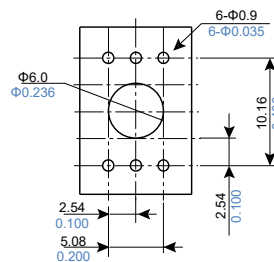

Terminal connection diagram

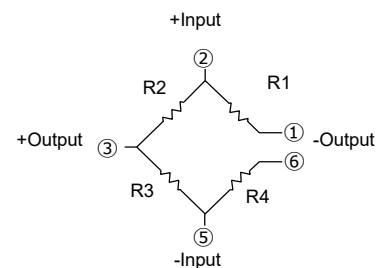

Terminal No.	Name
1	-Output (-)
2	Power supply (+)
3	+Output (+)
4	No connection
5	Power supply (-)
6	-Output (-)

Note: Leave terminal 4 unconnected.

unit : mm inch, General tolerance : ±0.3 ±0.012

Explanation of terms

■ Pressure object

This is what can be used to activate the pressure sensor.
(The Panasonic Corporation pressure sensor can be used with gas.)

■ Rated pressure

The pressure value up to which the specifications of the pressure sensor are guaranteed.

■ Maximum applied pressure

The maximum pressure that can be applied to the pressure sensor, after which, when the pressure is returned to below the rated pressure range, the specifications of the pressure sensor are guaranteed.

■ Temperature compensation range

The temperature range across which the specification values of the pressure sensor are guaranteed.

■ Drive current (voltage)

The supply current (voltage) required to drive a pressure sensor.

■ Output span voltage

The difference between the rated output voltage and the offset voltage. The output span voltage is also called the full-scale voltage (FS).

■ Offset voltage

The output voltage of a pressure sensor when no pressure is applied.

■ Rated pressure output voltage

Output voltage when rated pressure is applied.

■ Linearity

When the pressure is varied from no load to the rated pressure, the linearity is the amount of shift between the straight line that joins the no-load voltage value and the rated pressure voltage value (expressed as the ratio of the amount of shift (D1) at half of the rated pressure value with respect to the full scale voltage (FS)).

■ Output hysteresis

The ratio of the difference (D2) in the no-load output voltages when the pressure is varied from no load to the rated pressure then reduced back to no load, with respect to the full scale voltage (FS).

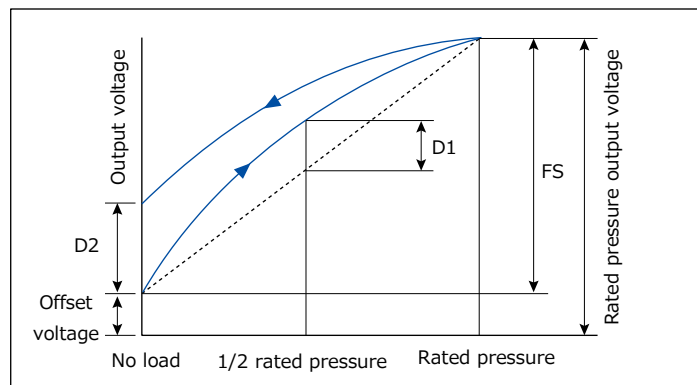

■ Offset voltage temperature characteristic

The variation of the offset voltage with changes in ambient temperature. The difference between the offset voltage at the standard temperature and the offset values at the compensation lower limit temperature (low temperature) (D1) and compensation upper limit temperature (high temperature) (D2) are obtained, and the offset voltage temperature characteristic is expressed as the ratio of the larger of these two differences (absolute) with respect to the full scale voltage (FS).

Explanation of terms

■ **Temperature sensitivity characteristic**

The variation of the sensitivity with changes in ambient temperature (variation in full scale (FS)). The difference between the full scale voltage at the standard temperature (FS) and the full scale values at the compensation lower limit temperature (low temperature) (FS1) and compensation upper limit temperature (high temperature) (FS2) are obtained, and the offset voltage temperature characteristic is expressed as the ratio of the larger of these two differences (FS1 - FS and FS2 - FS (absolute)) with respect to the full scale voltage (FS).

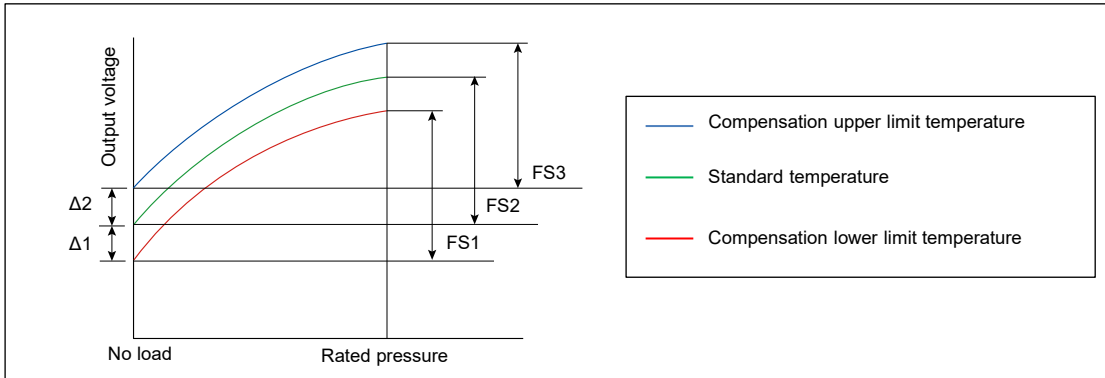

■ **Bridge resistance**

Refers to the resistance value of a piezo resistance formed on a monolithic silicon substrate. For example, the values of the resistances R1 to R4 in the bridge are typically 5 kΩ each.

* When the resistances of the resistive elements R1 to R4 that comprise the bridge are 5 kΩ each, the equivalent composite resistance of the bridge is 5kΩ (3 kΩ bridges are also available).

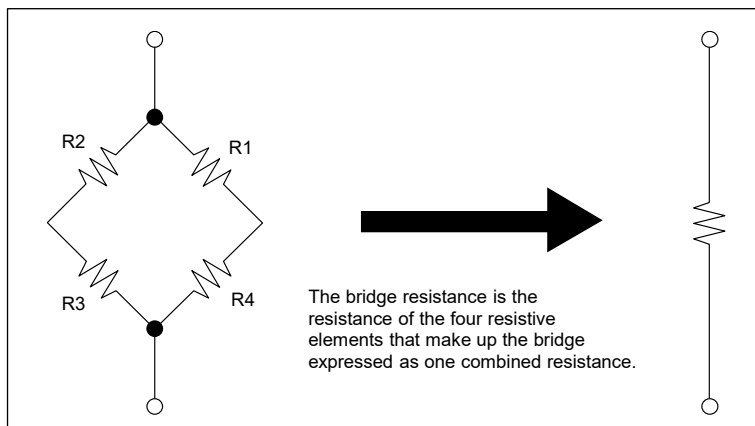

■ **Overall accuracy**

Accuracy of offset voltage and rated pressure output voltage within the temperature compensation range.

Safety Precautions

When using our products, no matter what sort of equipment they might be used for, be sure to confirm the applications and environmental conditions with our specifications in advance.

Panasonic
INDUSTRY

Panasonic Industry Co., Ltd.
Device Solutions Business Division

1006 Kadoma, Kadoma City, Osaka
571-8506 Japan