

Data sheet | Item number: 765-4103/100-000

4-Port IO-Link Master Class A; Profinet; DC 24 V / 2.0 A; 4xM12 connection;
SlimLine

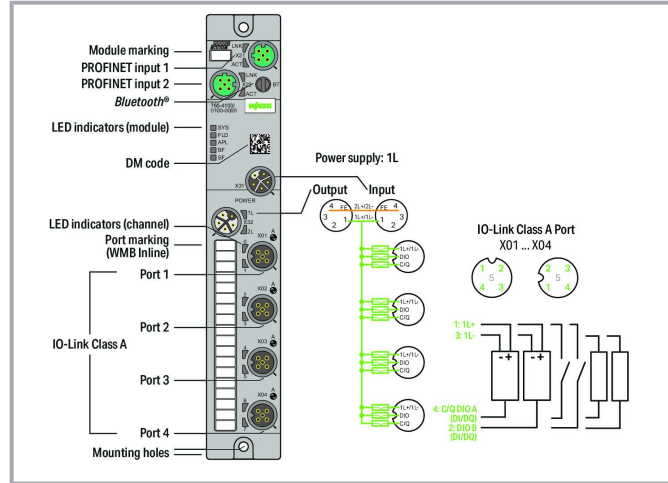

www.wago.com/765-4103/100-000



Data

Technical data

Fieldbus

Communication	PROFINET
Connection technology: communication/fieldbus	PROFINET IO device; 2-port switch, LLDP, MRP, SNMP
Interface standard	2 x D-coded M12; 4-pole
Autonegotiation; autocrossover	10BASE-T/100BASE-TX; potential-free
PROFINET IO features	yes
	PROFINET IO device; 2-port switch, LLDP, MRP, SNMP

Device functions

Parameter	Input filter
	Output current
	Temperature
Diagnostics	Undervoltage; Overcurrent; Overload; Overtemperature

Subject to changes. Please also observe the further product documentation!

WAGO GmbH & Co. KG
Hansastr. 27
32423 Minden
Phone: +49571 887-0 | Fax: +49571 887-169
Email: info.de@wago.com | Web: www.wago.com

Do you have any questions about our products?
We are always happy to take your call at +49 (571) 887-44222.



Device functions	Bluetooth® Bluetooth® OPC UA Server
Visualization	Web server Android/iOS app Webserver

IO-Link master

IO-Link master classification	Class A; V1.1 specification
Port mode	IO-Link: autoconfig, manual, tool-based DI DO
Cycle time	400 µs (min.)
Operating mode	IO-Link master, DI or DO (adjustable for pin 4 per port); DI or DO (adjustable for pin 2 per port)

IO-Link ports

Number of digital inputs	8
Number of digital outputs	8
Connection technology: inputs/outputs	4 x A-coded M12; 5-pole
Signal type (voltage)	24 VDC
Input characteristic	High-side switching
Input filter	0.2 ... 20 ms
Input characteristic	Type 3, per IEC 61131-2
Output current (per channel)	2 A (typ.) for DO
Supply current per port	1L: 1 A for IO-Link; 4 A (max.) for DIO

Supply (module)

Connection technology: supply	2 x L-coded M12; 5-pole
Supply voltage	24 VDC (18 ... 31.2 V); 1L
Current consumption (max.)	16000 mA
Current consumption (note)	per supply line; overload- and short-circuit-protected
Reverse voltage protection	Yes

Physical data

Width	35 mm / 1.378 inches
Height	30 mm / 1.181 inches
Depth	210 mm / 8.268 inches

Subject to changes. Please also observe the further product documentation!

WAGO GmbH & Co. KG
Hansastr. 27
32423 Minden
Phone: +49571 887-0 | Fax: +49571 887-169
Email: info.de@wago.com | Web: www.wago.com

Do you have any questions about our products?
We are always happy to take your call at +49 (571) 887-44222.

Mechanical Data

Weight	380 g
Conformity marking	CE

Environmental requirements

Ambient temperature (operation)	-25 ... +70 °C
Ambient temperature (storage)	-40 ... +80 °C
Protection type	IP67
Protection class	III per EN 61140, IEC 61140, VDE 0140-1
Operating altitude	0 ... 2000 m / 0 ... 6562 ft
Pollution degree	3 (EN 60664-1)
Overvoltage category	II (EN 60664-1)
Relative humidity (without condensation)	95 %
Vibration resistance	5g per IEC 60068-2-6
Shock resistance	Short-term: 50g/11 ms/half-sine per IEC 60068-2-27; Long-term: 30g/6 ms/half-sine per IEC 60068-2-29
EMC immunity to interference	per EN 61000-6-2
EMC emission of interference	per EN 61000-6-4

Commercial data

ETIM 8.0	EC001601
ETIM 7.0	EC001601
PU (SPU)	1 pcs
Packaging type	box
Country of origin	DE
GTIN	4055143950053
Customs tariff number	85371098990

Environmental Product Compliance

RoHS Compliance Status	Compliant, No Exemption
------------------------	-------------------------

Required accessories

Cover	
Cover	
 Item no.: 756-8102 M12 protective cap; for unused sockets	www.wago.com/756-8102



Subject to changes. Please also observe the further product documentation!

	Item no.: 756-8103 M12 protective cap; for unused plugs	www.wago.com/756-8103
---	---	--

Tool







Assembly tool		
	Item no.: 206-701 Torque wrench M8 and M12; Assembly kit	www.wago.com/206-701

Marking accessories













Marking strip		
	Item no.: 2009-110 Marking strips; for Smart Printer; on reel; not stretchable; plain; snap-on type; white	www.wago.com/2009-110
Marker		
	Item no.: 2009-115 WMB-Inline; for Smart Printer; 1500 pieces on roll; stretchable 5 - 5.2 mm; plain; snap-on type; white	www.wago.com/2009-115

Optional accessories

Cables and pluggable connectors

Sensor/actuator cable		
	Item no.: 756-5402/040-010 Sensor/Actuator cable; M12A socket; straight; M12A plug; angled; 4-pole; Length: 1 m	www.wago.com/756-5402/040-010
	Item no.: 756-5402/040-020 Sensor/Actuator cable; M12A socket; straight; M12A plug; angled; 4-pole; Length: 2 m	www.wago.com/756-5402/040-020
	Item no.: 756-5311/040-050 Sensor/Actuator cable; M12A plug; straight; 4-pole; Length: 5 m	www.wago.com/756-5311/040-050
	Item no.: 756-5311/040-015 Sensor/Actuator cable; M12A plug; straight; 4-pole; Length: 1.5 m	www.wago.com/756-5311/040-015
	Item no.: 756-5311/040-100 Sensor/Actuator cable; M12A plug; straight; 4-pole; Length: 10 m	www.wago.com/756-5311/040-100
	Item no.: 756-5404/040-020 Sensor/Actuator cable; M12A socket; angled; M12A plug; angled; 4-pole; Length: 2 m	www.wago.com/756-5404/040-020
	Item no.: 756-5510/040-010 Sensor/Actuator cable; M8 socket; angled; M12A plug; angled; 4-pole; Length: 1 m	www.wago.com/756-5510/040-010

Subject to changes. Please also observe the further product documentation!

	Item no.: 756-5510/040-020 Sensor/Actuator cable; M8 socket; angled; M12A plug; angled; 4-pole; Length: 2 m	www.wago.com/756-5510/040-020
	Item no.: 756-5401/040-020 Sensor/Actuator cable; M12A socket; straight; M12A plug; straight; 4-pole; Length: 2 m	www.wago.com/756-5401/040-020
	Item no.: 756-5401/040-010 Sensor/Actuator cable; M12A socket; straight; M12A plug; straight; 4-pole; Length: 1 m	www.wago.com/756-5401/040-010
	Item no.: 756-5507/040-010 Sensor/Actuator cable; M8 socket; straight; M12A plug; straight; 4-pole; Length: 1 m	www.wago.com/756-5507/040-010
	Item no.: 756-5507/040-020 Sensor/Actuator cable; M8 socket; straight; M12A plug; straight; 4-pole; Length: 2 m	www.wago.com/756-5507/040-020
	Item no.: 756-5404/040-010 Sensor/Actuator cable; M12A socket; angled; M12A plug; angled; 4-pole; Length: 1 m	www.wago.com/756-5404/040-010
	Item no.: 756-5312/040-015 Sensor/Actuator cable; M12A plug; angled; 4-pole; Length: 1.5 m	www.wago.com/756-5312/040-015
	Item no.: 756-5312/040-050 Sensor/Actuator cable; M12A plug; angled; 4-pole; Length: 5 m	www.wago.com/756-5312/040-050
	Item no.: 756-5509/040-010 Sensor/Actuator cable; M8 socket; angled; M12A plug; straight; 4-pole; Length: 1 m	www.wago.com/756-5509/040-010
	Item no.: 756-5509/040-020 Sensor/Actuator cable; M8 socket; angled; M12A plug; straight; 4-pole; Length: 2 m	www.wago.com/756-5509/040-020
	Item no.: 756-5403/040-010 Sensor/Actuator cable; M12A socket; angled; M12A plug; straight; 4-pole; Length: 1 m	www.wago.com/756-5403/040-010
	Item no.: 756-5312/040-100 Sensor/Actuator cable; M12A plug; angled; 4-pole; Length: 10 m	www.wago.com/756-5312/040-100
	Item no.: 756-5403/040-020 Sensor/Actuator cable; M12A socket; angled; M12A plug; straight; 4-pole; Length: 2 m	www.wago.com/756-5403/040-020

Subject to changes. Please also observe the further product documentation!



Item no.: 756-5508/040-010
Sensor/Actuator cable; M8 socket; straight; M12A plug; angled; 4-pole; Length: 1 m

www.wago.com/756-5508/040-010



Item no.: 756-5508/040-020
Sensor/Actuator cable; M8 socket; straight; M12A plug; angled; 4-pole; Length: 2 m

www.wago.com/756-5508/040-020

Configurable connectors



Item no.: 756-9202/040-000
Fitted pluggable connector; 4-pole; M12 plug, straight, A-coded; Spring

www.wago.com/756-9202/040-000



Item no.: 756-9205/040-000
Fitted pluggable connector; 4-pole; M12 plug, right angle; Spring

www.wago.com/756-9205/040-000



Item no.: 756-9711/050-000
Fitted pluggable connector; 5-pole, shielded; M12 socket, straight; IDC technology

www.wago.com/756-9711/050-000



Item no.: 756-9701/050-000
Fitted pluggable connector; 5-pole, shielded; M12 plug, straight; IDC technology

www.wago.com/756-9701/050-000

Configurable shielded connectors



Item no.: 756-9501/060-000
Fitted pluggable connector; 4-pole, shielded; M12 plug, straight, D-coded; Spring

www.wago.com/756-9501/060-000



Item no.: 756-9501/040-000
Accessories; M12 plug, right angle; 4-pole

www.wago.com/756-9501/040-000

Power cable



Item no.: 756-3501/050-075
Power cable; M12L socket; straight; 5-pole; Length: 7.5 m

www.wago.com/756-3501/050-075



Item no.: 756-3501/050-100
Power cable; M12L socket; straight; 5-pole; Length: 10 m

www.wago.com/756-3501/050-100



Item no.: 756-3501/050-150
Power cable; M12L socket; straight; 5-pole; Length: 15 m

www.wago.com/756-3501/050-150

Subject to changes. Please also observe the further product documentation!



Item no.: 756-3501/050-050
Power cable; M12L socket; straight; 5-pole; Length: 5 m

www.wago.com/756-3501/050-050



Item no.: 756-3502/050-050
Power cable; M12L socket; angled; 5-pole; Length: 5 m

www.wago.com/756-3502/050-050



Item no.: 756-3502/050-150
Power cable; M12L socket; angled; 5-pole; Length: 15 m

www.wago.com/756-3502/050-150



Item no.: 756-3502/050-075
Power cable; M12L socket; angled; 5-pole; Length: 7.5 m

www.wago.com/756-3502/050-075



Item no.: 756-3502/050-100
Power cable; M12L socket; angled; 5-pole; Length: 10 m

www.wago.com/756-3502/050-100



Item no.: 756-3503/050-075
Power cable; M12L plug; straight; 5-pole; Length: 7.5 m

www.wago.com/756-3503/050-075



Item no.: 756-3503/050-150
Power cable; M12L plug; straight; 5-pole; Length: 15 m

www.wago.com/756-3503/050-150



Item no.: 756-3503/050-100
Power cable; M12L plug; straight; 5-pole; Length: 10 m

www.wago.com/756-3503/050-100



Item no.: 756-3505/050-003
Power cable; M12L socket; straight; M12L plug; straight; 5-pole; Length: 0.3 m

www.wago.com/756-3505/050-003



Item no.: 756-3505/050-005
Power cable; M12L socket; straight; M12L plug; straight; 5-pole; Length: 0.5 m

www.wago.com/756-3505/050-005



Item no.: 756-3505/050-020
Power cable; M12L socket; straight; M12L plug; straight; 5-pole; Length: 2 m













www.wago.com/756-3505/050-020



Item no.: 756-3505/050-010
Power cable; M12L socket; straight; M12L plug; straight; 5-pole; Length: 1 m

www.wago.com/756-3505/050-010

Subject to changes. Please also observe the further product documentation!

	Item no.: 756-3505/050-050 Power cable; M12L socket; straight; M12L plug; straight; 5-pole; Length: 5 m	www.wago.com/756-3505/050-050
	Item no.: 756-3505/050-075 Power cable; M12L socket; straight; M12L plug; straight; 5-pole; Length: 7.5 m	www.wago.com/756-3505/050-075
	Item no.: 756-3505/050-100 Power cable; M12L socket; straight; M12L plug; straight; 5-pole; Length: 10 m	www.wago.com/756-3505/050-100
	Item no.: 756-3506/050-100 Power cable; M12L socket; angled; M12L plug; angled; 5-pole; Length: 10 m	www.wago.com/756-3506/050-100
	Item no.: 756-3506/050-075 Power cable; M12L socket; angled; M12L plug; angled; 5-pole; Length: 7.5 m	www.wago.com/756-3506/050-075
	Item no.: 756-3506/050-150 Power cable; M12L socket; angled; M12L plug; angled; 5-pole; Length: 15 m	www.wago.com/756-3506/050-150
	Item no.: 756-3501/050-020 Power cable; M12L socket; straight; 5-pole; Length: 2 m	www.wago.com/756-3501/050-020
	Item no.: 756-3502/050-020 Power cable; M12L socket; angled; 5-pole; Length: 2 m	www.wago.com/756-3502/050-020
	Item no.: 756-3503/050-020 Power cable; M12L plug; straight; 5-pole; Length: 2 m	www.wago.com/756-3503/050-020
	Item no.: 756-3503/050-050 Power cable; M12L plug; straight; 5-pole; Length: 5 m	www.wago.com/756-3503/050-050
	Item no.: 756-3504/050-020 Power cable; M12L plug; angled; 5-pole; Length: 2 m	www.wago.com/756-3504/050-020
	Item no.: 756-3504/050-050 Power cable; M12L plug; angled; 5-pole; Length: 5 m	www.wago.com/756-3504/050-050

Subject to changes. Please also observe the further product documentation!



Item no.: 756-3504/050-075
Power cable; M12L plug; angled; 5-pole; Length: 7.5 m

www.wago.com/756-3504/050-075



Item no.: 756-3504/050-100
Power cable; M12L plug; angled; 5-pole; Length: 10 m

www.wago.com/756-3504/050-100



Item no.: 756-3504/050-150
Power cable; M12L plug; angled; 5-pole; Length: 15 m

www.wago.com/756-3504/050-150



Item no.: 756-3505/050-150
Power cable; M12L socket; straight; M12L plug; straight; 5-pole; Length: 15 m

www.wago.com/756-3505/050-150



Item no.: 756-3506/050-003
Power cable; M12L socket; angled; M12L plug; angled; 5-pole; Length: 0.3 m

www.wago.com/756-3506/050-003



Item no.: 756-3506/050-005
Power cable; M12L socket; angled; M12L plug; angled; 5-pole; Length: 0.5 m

www.wago.com/756-3506/050-005



Item no.: 756-3506/050-020
Power cable; M12L socket; angled; M12L plug; angled; 5-pole; Length: 2 m

www.wago.com/756-3506/050-020



Item no.: 756-3506/050-010
Power cable; M12L socket; angled; M12L plug; angled; 5-pole; Length: 1 m

www.wago.com/756-3506/050-010



Item no.: 756-3506/050-050
Power cable; M12L socket; angled; M12L plug; angled; 5-pole; Length: 5 m

www.wago.com/756-3506/050-050

Distribution connector



Item no.: 756-5513/040-010
Sensor/Actuator cable; 2xM8 socket; straight; M12A plug; straight; 4-pole; Length: 1 m

www.wago.com/756-5513/040-010



Item no.: 756-5513/040-020
Sensor/Actuator cable; 2xM8 socket; straight; M12A plug; straight; 4-pole; Length: 2 m

www.wago.com/756-5513/040-020



Item no.: 756-5514/040-010
Sensor/Actuator cable; 2xM8 socket; angled; M12A plug; straight; 4-pole; Length: 1 m

www.wago.com/756-5514/040-010

Subject to changes. Please also observe the further product documentation!

WAGO GmbH & Co. KG

Hansastr. 27

32423 Minden

Phone: +49571 887-0 | Fax: +49571 887-169

Email: info.de@wago.com | Web: www.wago.com

Do you have any questions about our products?

We are always happy to take your call at +49 (571) 887-44222.



Item no.: 756-5514/040-020
Sensor/Actuator cable; 2xM8 socket; angled; M12A plug; straight; 4-pole; Length: 2 m

www.wago.com/756-5514/040-020



Item no.: 756-5516/040-010
Sensor/Actuator cable; 2xM12 socket; straight; M12A plug; straight; 4-pole; Length: 1 m

www.wago.com/756-5516/040-010



Item no.: 756-5516/040-020
Sensor/Actuator cable; 2xM12 socket; straight; M12A plug; straight; 4-pole; Length: 2 m

www.wago.com/756-5516/040-020



Item no.: 756-5517/040-010
Sensor/Actuator cable; 2xM12 socket; angled; M12A plug; straight; 4-pole; Length: 1 m

www.wago.com/756-5517/040-010



Item no.: 756-5517/040-020
Sensor/Actuator cable; 2xM12 socket; angled; M12A plug; straight; 4-pole; Length: 2 m

www.wago.com/756-5517/040-020



Item no.: 756-9301/050-000
Accessories; 5-pole

www.wago.com/756-9301/050-000



Item no.: 756-9301/040-000
Accessories; 4-pole

www.wago.com/756-9301/040-000

Adapter



Item no.: 756-9503/040-000
Accessories; 4-pole

www.wago.com/756-9503/040-000



Item no.: 756-9504/040-000
Accessories; 4-pole

www.wago.com/756-9504/040-000

ETHERNET/PROFINET cable



Item no.: 756-1202/060-200
ETHERNET cable; M12D plug; angled; 4-pole; Length: 20 m

www.wago.com/756-1202/060-200



Item no.: 756-1201/060-100
ETHERNET cable; M12D plug; straight; 4-pole; Length: 10 m

www.wago.com/756-1201/060-100

Subject to changes. Please also observe the further product documentation!



Item no.: 756-1201/060-050
ETHERNET cable; M12D plug; straight; 4-pole; Length: 5 m

www.wago.com/756-1201/060-050



Item no.: 756-1203/060-050
ETHERNET cable; M12D plug; straight; M12D plug; straight; 4-pole; Length: 5 m

www.wago.com/756-1203/060-050



Item no.: 756-1203/060-020
ETHERNET cable; M12D plug; straight; M12D plug; straight; 4-pole; Length: 2 m

www.wago.com/756-1203/060-020



Item no.: 756-1202/060-020
ETHERNET cable; M12D plug; angled; 4-pole; Length: 2 m

www.wago.com/756-1202/060-020



Item no.: 756-1201/060-200
ETHERNET cable; M12D plug; straight; 4-pole; Length: 20 m

www.wago.com/756-1201/060-200



Item no.: 756-1204/060-050
ETHERNET cable; M12D plug; angled; M12D plug; angled; 4-pole; Length: 5 m

www.wago.com/756-1204/060-050



Item no.: 756-1204/060-100
ETHERNET cable; M12D plug; angled; M12D plug; angled; 4-pole; Length: 10 m

www.wago.com/756-1204/060-100



Item no.: 756-1204/060-200
ETHERNET cable; M12D plug; angled; M12D plug; angled; 4-pole; Length: 20 m

www.wago.com/756-1204/060-200



Item no.: 756-1203/060-200
ETHERNET cable; M12D plug; straight; M12D plug; straight; 4-pole; Length: 20 m

www.wago.com/756-1203/060-200



Item no.: 756-1203/060-100
ETHERNET cable; M12D plug; straight; M12D plug; straight; 4-pole; Length: 10 m

www.wago.com/756-1203/060-100



Item no.: 756-1204/060-010
ETHERNET cable; M12D plug; angled; M12D plug; angled; 4-pole; Length: 1 m

www.wago.com/756-1204/060-010



Item no.: 756-1204/060-030
ETHERNET cable; M12D plug; angled; M12D plug; angled; 4-pole; Length: 3 m

www.wago.com/756-1204/060-030

Subject to changes. Please also observe the further product documentation!



Item no.: 756-1204/060-020
ETHERNET cable; M12D plug; angled; M12D plug; angled; 4-pole; Length: 2 m

www.wago.com/756-1204/060-020



Item no.: 756-1202/060-050
ETHERNET cable; M12D plug; angled; 4-pole; Length: 5 m

www.wago.com/756-1202/060-050



Item no.: 756-1202/060-100
ETHERNET cable; M12D plug; angled; 4-pole; Length: 10 m

www.wago.com/756-1202/060-100



Item no.: 756-1201/060-020
ETHERNET cable; M12D plug; straight; 4-pole; Length: 2 m

www.wago.com/756-1201/060-020

Downloads

Documentation

Manual

Product Manual 4-Port IO-Link Master Class A; Profinet DC 24 V / 2.0 A; 4xM12 Connection; SlimLine	V 2.2.0 2022 Jul 28	pdf 8.7 MB	Download
--	------------------------	---------------	----------

Instruction Leaflet

I/O System Field package insert	2021 Dec 15	pdf 1.1 MB	Download
---------------------------------	-------------	---------------	----------

System Description

WAGO I/O System Field; General Product Information		pdf 1.0 MB	Download
--	--	---------------	----------

Engineering-Software

WAGO IO-Link Configurator

WAGO IO-Link Configurator	V5.1.1-6618 2022 Feb 16	ZIP 91.8 MB	Download
---------------------------	----------------------------	----------------	----------

WAGO IO-Link Configurator allows configuration, parameterization, operation and monitoring of WAGO IO-Link Masters in the WAGO I/O System 750 and WAGO I/O System Field, and especially of the WAGO IO-Link devices connected to them.

Additionally, WAGO IO-Link Configurator can be used for complete configuration and operation of all IO-Link devices of third-party manufacturers, as long as they comply with the IO-Link specification. A product's process data can be visualized graphically and stored in trend curves. Up to eight elements can be selected for visualization, and the data can be recorded for up to 24 hours.

Subject to changes. Please also observe the further product documentation!

WAGO GmbH & Co. KG
Hansastr. 27
32423 Minden
Phone: +49571 887-0 | Fax: +49571 887-169
Email: info.de@wago.com | Web: www.wago.com

Do you have any questions about our products?
We are always happy to take your call at +49 (571) 887-44222.



Device description files for the IO-Link Masters (IOLM) or IO-Link Devices (IODD) can be used to integrate new devices into the tool at any time. Convenient access to the IO-Link user organization's IODDfinder is available for the IODDs. This allows automated, selective download of IODDs when integrating new IO-Link devices. An integrated IODD viewer allows detailed insight into the IODD device description.

WAGO IO-Link Configurator can be used either as a standalone program or integrated into engineering systems with a TCI interface and *WAGO-I/O-CHECK*.

IO-Link Configurator can also be used to integrate the IO-Link Master (750-657) of the WAGO I/O System 750 Series and to access all the configurator's functions. This is made possible by the WAGO I/O System 750 IO-Link Adapter, which can be retrofitted. The WAGO I/O System 750 IO-Link Adapter requires the current version of WAGO IO-Link Configurator and a current version of *WAGO-I/O-CHECK*.

In addition, the download file contains the device descriptions for the respective fieldbus systems of the WAGO I/O System Field modules. These are pre-installed in the Configurator setup.

The WAGO IO-Link Configurator license is assigned to the specific PC on which it is installed (a workstation license).

Register now and test our engineering software for 30 days at no cost.

CAD/CAE-Data

CAD data

2D/3D Models 765-4103/100-000	URL	Download
-------------------------------	---------------------	--------------------------

CAE data

ZUKEN Portal 765-4103/100-000	URL	Download
-------------------------------	---------------------	--------------------------

EPLAN Data Portal 765-4103/100-000	URL	Download
------------------------------------	---------------------	--------------------------

Device Files

Device Description File

750-916; GSD files of version 2.x for PROFINET/ series 750/753, 765, 767 and 852	3.0 2023 Jan 15	zip 2.6 MB	Download
--	--------------------	---------------	--------------------------

Gerätebeschreibungdateien 765-41xx, 765-11xx, PROFINET	V1_1_0_20	zip 27.5 kB	Download
--	-----------	----------------	--------------------------

Environmental Product Compliance

Compliance Search

Environmental Product Compliance 765-4103/100-000 4-Port IO-Link Master Class A; Profinet; DC 24 V / 2.0 A; 4xM12 connection; SlimLine	URL	Download
---	---------------------	--------------------------

Subject to changes. Please also observe the further product documentation!

WAGO GmbH & Co. KG
 Hansastr. 27
 32423 Minden
 Phone: +49571 887-0 | Fax: +49571 887-169
 Email: info.de@wago.com | Web: www.wago.com

Do you have any questions about our products?
 We are always happy to take your call at +49 (571) 887-44222.



Installation Notes

Product family

WAGO I/O System Field

Show all products from the family

Subject to changes. Please also observe the further product documentation!

WAGO GmbH & Co. KG

Hansastr. 27

32423 Minden

Phone: +49571 887-0 | Fax: +49571 887-169

Email: info.de@wago.com | Web: www.wago.com

Do you have any questions about our products?

We are always happy to take your call at +49 (571) 887-44222.