

Retroreflective sensor MLV12-54-LAS/92/120

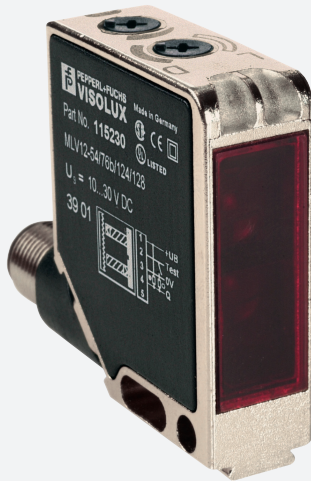

- Series of sensors in a widely used standard housing
- Visible red light, pulsed LASER light
- Precision: high degree of repeatability thanks to small light spot
- Objects can be reliably detected down to 0 mm: no blind zone
- Resistant against noise: reliable operation under all conditions
- High level of stability thanks to the metal housing frame

Laser retroreflective sensor, small design, polarization filter, 21 m detection range, laser red light, light/dark on, 2 PNP outputs, M12 plug



Safety Information

Laser Class 1 Information

The irradiation can lead to irritation especially in a dark environment. Do not point at people!

Maintenance and repairs should only be carried out by authorized service personnel!

Attach the device so that the warning is clearly visible and readable.

The warning accompanies the device and should be attached in immediate proximity to the device.

Caution – Use of controls or adjustments or performance of procedures other than those specified herein may result in hazardous radiation exposure.

Dimensions

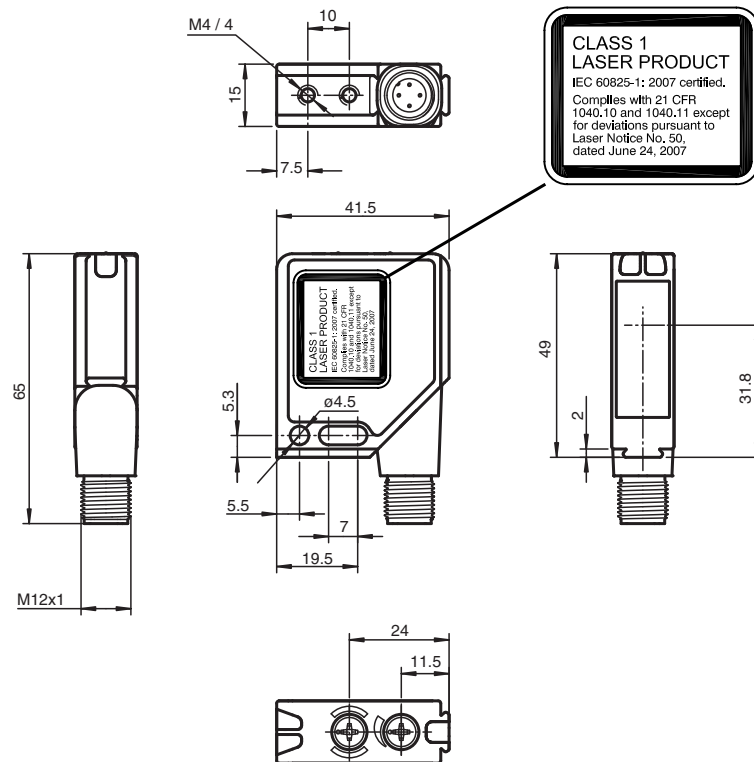

Technical Data

General specifications

Effective detection range	0 ... 12 m
Reflector distance	0 ... 12 m
Threshold detection range	17 m
Reference target	MH82 reflector
Light source	laser diode
Light type	modulated visible red light
Polarization filter	yes
Laser nominal ratings	
Note	LASER LIGHT , DO NOT STARE INTO BEAM
Laser class	1
Wave length	650 nm
Beam divergence	< 1.5 mrad
Pulse length	1.8 μ s
Repetition rate	17.86 kHz
max. pulse energy	6.7 nJ
Diameter of the light spot	approx. 5 mm x 12 mm at 15 m detection range
Opening angle	0.02 °
Ambient light limit	
Continuous light	50000 Lux
Modulated light	5000 Lux

Functional safety related parameters

Release date: 2022-02-07 Date of issue: 2022-02-07 Filename: 128108_eng.pdf

Refer to "General Notes Relating to Pepperl+Fuchs Product Information".

Technical Data

MTTF _d		930 a
Mission Time (T _M)		10 a
Diagnostic Coverage (DC)		0 %
Indicators/operating means		
Operation indicator		LED green, flashes in case of short-circuit
Function indicator		2 LEDs yellow, light up when light beam is free, flash when falling short of the stability control, off when light beam is interrupted
Control elements		rotary switch for light/dark, sensitivity adjuster
Electrical specifications		
Operating voltage	U _B	10 ... 30 V DC
Ripple		max. 10 %
No-load supply current	I ₀	max. 40 mA
Output		
Switching type		light/dark on switchable
Signal output		2 PNP outputs, complementary, short-circuit protected, reverse polarity protected, open collector
Switching voltage		max. 30 V DC
Switching current		max. 0.1 A
Voltage drop	U _d	≤ 2.5 V DC
Switching frequency	f	2500 Hz
Response time		0.2 ms
Conformity		
Product standard		EN 60947-5-2
Laser safety		IEC 60825-1:2007 Complies with 21 CFR 1040.10 and 1040.11 except for deviations pursuant to Laser Notice No. 50, dated June 24, 2007
Compliance with standards and directives		
Standard conformity		
Shock and impact resistance		IEC / EN 60068. half-sine, 40 g in each X, Y and Z directions
Vibration resistance		IEC / EN 60068-2-6. Sinus. 10 -150 Hz, 5 g in each X, Y and Z directions
Laser class		IEC 60825-1:2007 Complies with 21 CFR 1040.10 and 1040.11 except for deviations pursuant to Laser Notice No. 50, dated June 24, 2007
Approvals and certificates		
EAC conformity		TR CU 020/2011
Protection class		II, rated voltage ≤ 300 V AC with pollution degree 1-2 according to IEC 60664-1
UL approval		cULus Listed, Type 1 enclosure
CCC approval		CCC approval / marking not required for products rated ≤36 V
Ambient conditions		
Ambient temperature		-10 ... 50 °C (14 ... 122 °F)
Storage temperature		-20 ... 65 °C (-4 ... 149 °F)
Mechanical specifications		
Housing width		41.5 mm
Housing height		49 mm
Housing depth		15 mm
Degree of protection		IP67
Connection		4-pin, M12 metal connector, 90° rotatable
Material		
Housing		Frame: nickel plated, die cast zinc, Laterals: glass-fiber reinforced plastic PC
Optical face		Plastic pane
Mass		60 g

Release date: 2022-02-07 Date of issue: 2022-02-07 Filename: 128108_eng.pdf

Connection

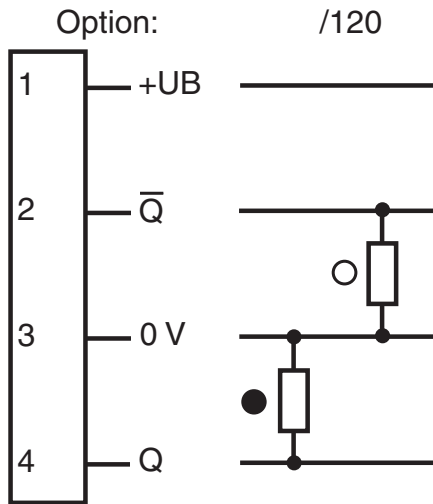

○ = Light on
● = Dark on

Connection Assignment

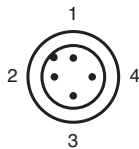

Wire colors in accordance with EN 60947-5-2

1	BN	(brown)
2	WH	(white)
3	BU	(blue)
4	BK	(black)

Assembly

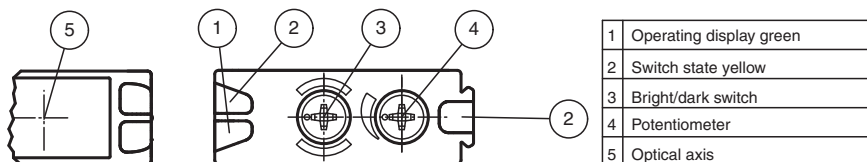

Release date: 2022-02-07 Date of issue: 2022-02-07 Filename: 128108_eng.pdf

Refer to "General Notes Relating to Pepperl+Fuchs Product Information".

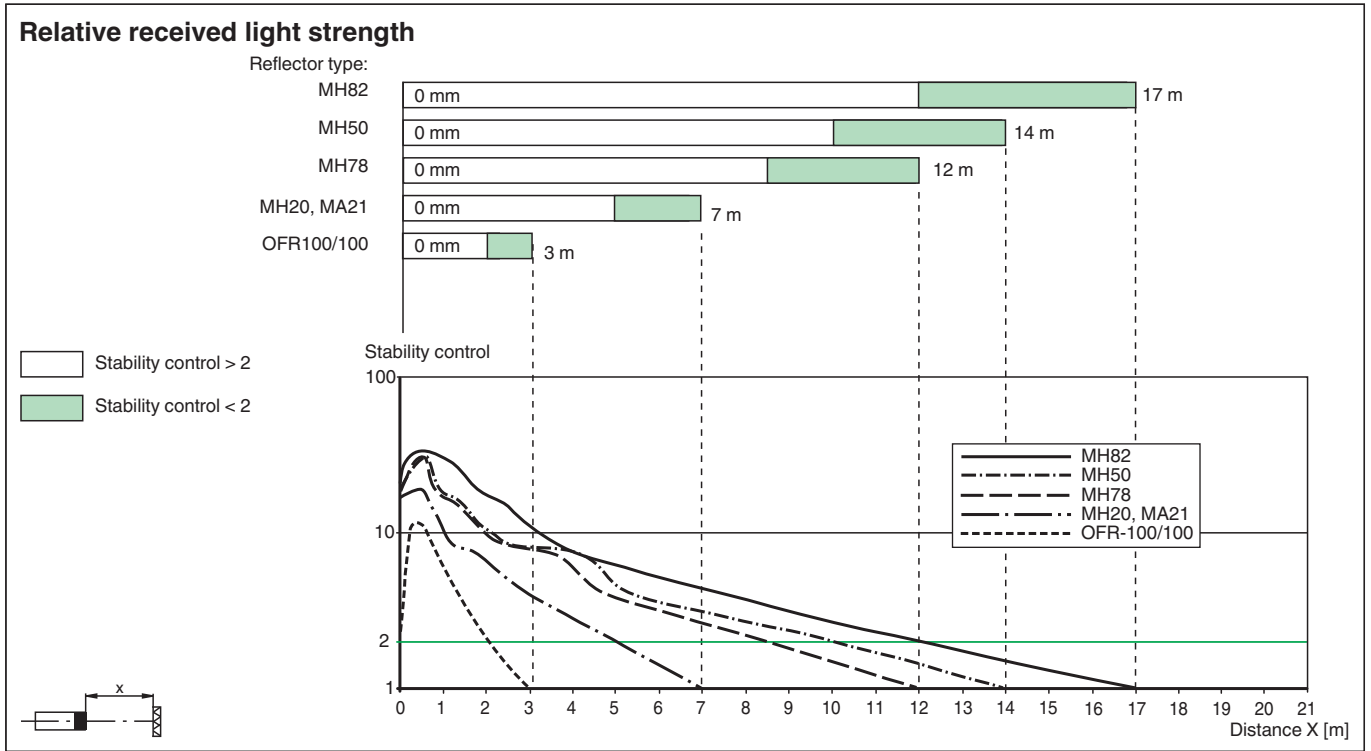

Characteristic Curve

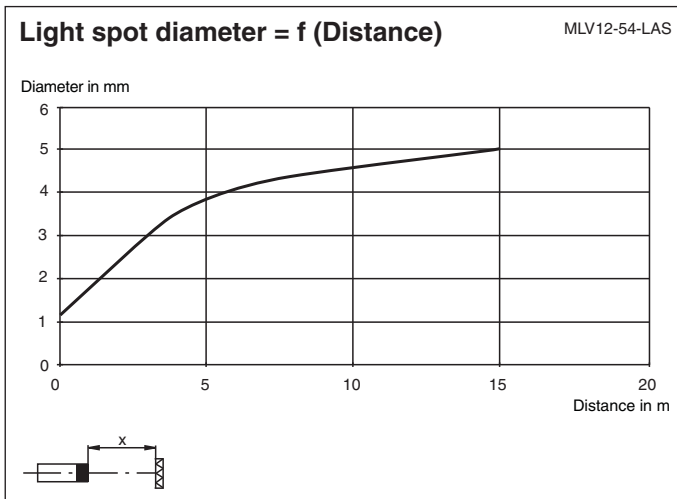

System Description

System Description

The retro-reflective sensor contains both an emitter and a receiver in a single housing. A reflector reflects the light from emitter back to the receiver. If an object interrupts the light beam, the switching function is initiated.

Installation

Mounting

The sensors can be secured directly using thru-holes or using a mounting bracket or mounting clamp. Mounting brackets and clamping elements are available as accessories.

Ensure that the background is level to prevent the housing from becoming distorted when the fittings are tightened.

Secure the nut and screw with spring disks to prevent the sensor from becoming misaligned.

Commissioning

Aligning the sensor: Apply the operating voltage to the sensor. The operating indicator lights up green.

Mount a suitable reflector opposite the light barrier. Roughly align the sensor (without an object) with the reflector. Next, adjust the sensor to the reflector by swiveling the sensor horizontally and vertically so that the yellow signal indicator lights up continuously. In the event of misalignment, the yellow signal indicator flashes.

Release date: 2022-02-07 Date of issue: 2022-02-07 Filename: 128108_eng.pdf

Commissioning

Checking object detection: Follow the steps below to check that the sensor detects objects as required.

Position the object in the beam path of the sensor.

When the object is detected, the yellow signal indicator goes out. If the yellow signal indicator remains lit, reduce the sensitivity of the potentiometer until the yellow signal indicator goes out.

When the object disappears from the beam path of the sensor, the yellow signal indicator lights up again continuously.





Maintenance

Maintenance

Cleaning: If the transmission reception deteriorates, e.g., due to dirt, the yellow signal indicator on the receiver flashes. Clean the optical interfaces of the sensor (e.g., lenses) at regular intervals.

Maintenance: Check the mounting fittings and the electrical connections regularly.

Accessories

	OMH-MLV12-HWG	Mounting bracket for series MLV12 sensors
	OMH-MLV12-HWK	Mounting bracket for series MLV12 sensors
	OMH-K01	dove tail mounting clamp
	OMH-K02	dove tail mounting clamp
	OMH-K03	dove tail mounting clamp
	OMH-01	Mounting aid for round steel \varnothing 12 mm or sheet 1.5 mm ... 3 mm
	OMH-06	Mounting aid for round steel \varnothing 12 mm or sheet 1.5 mm ... 3 mm
	REF-MH82	Reflector with Micro-structure, rectangular 82 mm x 60 mm, mounting holes
	REF-MH78	Reflector with Micro-structure, hexagonal 78 mm x 61 mm, mounting holes
	REF-MH20	Reflector with Micro-structure, rectangular 32 mm x 20 mm, mounting holes
	REF-MA21	Reflector with Micro-structure, round \varnothing 21 mm, self-adhesive