



# WL9G-3P2432

W9

SMALL PHOTOELECTRIC SENSORS

**SICK**  
Sensor Intelligence.



Illustration may differ



### Ordering information

Type	Part no.
WL9G-3P2432	1049083

Other models and accessories → [www.sick.com/W9](http://www.sick.com/W9)

### Detailed technical data

#### Features

<b>Functional principle</b>	Photoelectric retro-reflective sensor
<b>Functional principle detail</b>	Autocollimation
<b>Dimensions (W x H x D)</b>	12.2 mm x 52.2 mm x 23.6 mm
<b>Housing design (light emission)</b>	Rectangular
<b>Mounting hole</b>	M3
<b>Sensing range max.</b>	0 m ... 5 m <sup>1)</sup>
<b>Sensing range</b>	0 m ... 3 m <sup>1)</sup>
<b>Type of light</b>	Visible red light
<b>Light source</b>	PinPoint LED <sup>2)</sup>
<b>Light spot size (distance)</b>	Ø 45 mm (1.5 m)
<b>Wave length</b>	650 nm
<b>Adjustment</b>	Single teach-in button
<b>AutoAdapt</b>	✓
<b>Special applications</b>	Detecting transparent objects

<sup>1)</sup> Reflector PL80A.

<sup>2)</sup> Average service life: 100,000 h at T<sub>J</sub> = +25 °C.

## Mechanics/electronics

<b>Supply voltage</b>	10 V DC ... 30 V DC <sup>1)</sup>
<b>Ripple</b>	< 5 V <sub>pp</sub> <sup>2)</sup>
<b>Current consumption</b>	20 mA <sup>3)</sup>
<b>Switching output</b>	PNP <sup>4)</sup>
<b>Output function</b>	Complementary
<b>Switching mode</b>	Light/dark switching <sup>4)</sup>
<b>Output current I<sub>max.</sub></b>	≤ 100 mA <sup>5)</sup>
<b>Response time</b>	< 0.5 ms <sup>6)</sup>
<b>Switching frequency</b>	1,000 Hz <sup>7)</sup>
<b>Connection type</b>	Male connector M12, 4-pin
<b>Circuit protection</b>	A <sup>8)</sup> B <sup>9)</sup> C <sup>10)</sup>
<b>Protection class</b>	III
<b>Weight</b>	13 g
<b>Polarisation filter</b>	✓
<b>Housing material</b>	Plastic, VISTAL®
<b>Optics material</b>	Plastic, PMMA
<b>Enclosure rating</b>	IP66 IP67 IP69K
<b>Special feature</b>	Detecting transparent objects
<b>Ambient operating temperature</b>	-40 °C ... +60 °C
<b>Ambient temperature, storage</b>	-40 °C ... +75 °C
<b>UL File No.</b>	NRKH.E181493

<sup>1)</sup> Limit values when operated in short-circuit protected network: max. 8 A.

<sup>2)</sup> May not exceed or fall below U<sub>v</sub> tolerances.

<sup>3)</sup> Without load.

<sup>4)</sup> Q = light switching.

<sup>5)</sup> At and above T<sub>u</sub> 50 °C, a max. load current of I<sub>max.</sub> = 50 mA is permitted.

<sup>6)</sup> Signal transit time with resistive load.

<sup>7)</sup> With light/dark ratio 1:1.

<sup>8)</sup> A = V<sub>S</sub> connections reverse-polarity protected.

<sup>9)</sup> B = inputs and output reverse-polarity protected.

<sup>10)</sup> C = interference suppression.

## Safety-related parameters

<b>MTTF<sub>D</sub></b>	1,232 years
<b>DC<sub>avg</sub></b>	0 %

## Classifications

<b>eCl@ss 5.0</b>	27270902
<b>eCl@ss 5.1.4</b>	27270902
<b>eCl@ss 6.0</b>	27270902

<b>eCl@ss 6.2</b>	27270902
<b>eCl@ss 7.0</b>	27270902
<b>eCl@ss 8.0</b>	27270902
<b>eCl@ss 8.1</b>	27270902
<b>eCl@ss 9.0</b>	27270902
<b>eCl@ss 10.0</b>	27270902
<b>eCl@ss 11.0</b>	27270902
<b>eCl@ss 12.0</b>	27270902
<b>ETIM 5.0</b>	EC002717
<b>ETIM 6.0</b>	EC002717
<b>ETIM 7.0</b>	EC002717
<b>ETIM 8.0</b>	EC002717
<b>UNSPSC 16.0901</b>	39121528

### Connection type

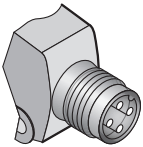

### Connection diagram

Cd-084

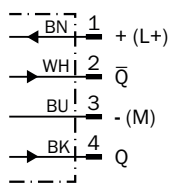

### Characteristic curve

WL9G-3

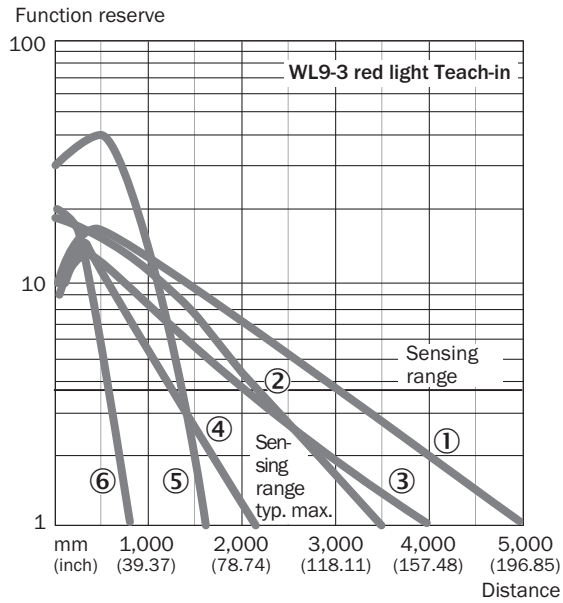

- ① Reflector PL80A
- ② Reflector P250F
- ③ Reflector PL40A
- ④ Reflector PL20F
- ⑤ PL10F reflector
- ⑥ Reflective tape REF-IRF-56

### Light spot size

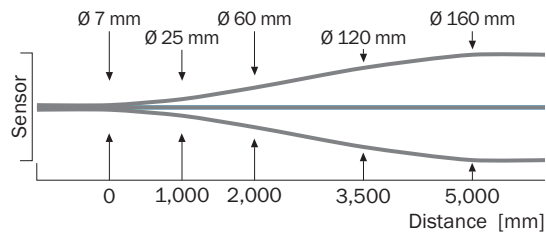

### Sensing range diagram

WL9G-3

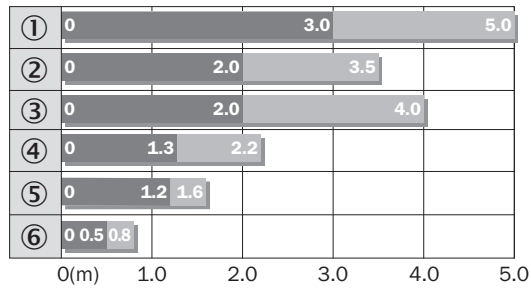

- Sensing range
- Sensing range max.
- ① Reflector PL80A
- ② Reflector P250F
- ③ Reflector PL40A
- ④ Reflector PL20F
- ⑤ PL10F reflector
- ⑥ Reflective tape REF-IRF-56

### Adjustments

Single teach-in button

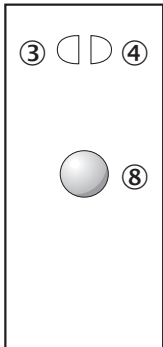

- ③ LED indicator yellow: Status of received light beam
- ④ LED indicator green: power on
- ⑧ Teach-in button

Dimensional drawing (Dimensions in mm (inch))



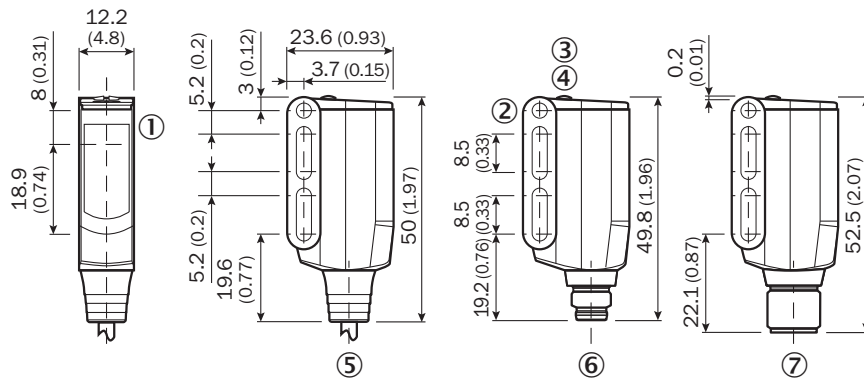

WL9-3, WSE9-3



- ① Sender and receiver optical axis center
- ② Mounting hole M3 (Ø 3.1 mm)
- ③ LED indicator yellow: Status of received light beam
- ④ LED indicator green: power on
- ⑤ Connecting cable or connector
- ⑥ Male connector M8, 4-pin
- ⑦ Male connector M12, 4-pin

Recommended accessories

Other models and accessories → [www.sick.com/W9](http://www.sick.com/W9)

	Brief description	Type	Part no.
<b>Mounting brackets and plates</b>			
	Mounting bracket, steel, zinc coated, mounting hardware included	BEF-WN-W9-2	2022855
<b>Plug connectors and cables</b>			
	Head A: female connector, M12, 4-pin, straight, A-coded Head B: Flying leads Cable: Sensor/actuator cable, PVC, unshielded, 5 m	YF2A14-050VB3XLEAX	2096235
	Head A: male connector, M12, 4-pin, straight Cable: unshielded	STE-1204-G	6009932
<b>Reflectors</b>			
	Fine triple reflector, screw connection, suitable for laser sensors, 52 mm x 62 mm, PM-MA/ABS, Screw-on, 2 hole mounting	P250F	5308843

## SICK AT A GLANCE

SICK is one of the leading manufacturers of intelligent sensors and sensor solutions for industrial applications. A unique range of products and services creates the perfect basis for controlling processes securely and efficiently, protecting individuals from accidents and preventing damage to the environment.

We have extensive experience in a wide range of industries and understand their processes and requirements. With intelligent sensors, we can deliver exactly what our customers need. In application centers in Europe, Asia and North America, system solutions are tested and optimized in accordance with customer specifications. All this makes us a reliable supplier and development partner.

Comprehensive services complete our offering: SICK LifeTime Services provide support throughout the machine life cycle and ensure safety and productivity.

For us, that is “Sensor Intelligence.”

## WORLDWIDE PRESENCE:

Contacts and other locations –[www.sick.com](http://www.sick.com)