

# XS108B3NAL2

inductive sensor XS1 M8, L33mm, brass,  
Sn2.5mm, 12..24VDC, cable 2m



## Main

Range of Product	Telemecanique Inductive proximity sensors XS
Series name	General purpose
Sensor Type	Inductive proximity sensor
Sensor name	XS1
Sensor design	Cylindrical M8
Size	33 mm
Body type	Fixed
Detector flush mounting acceptance	Flush mountable
Material	Metal
Type of output signal	Discrete
Wiring Technique	3-wire
[Sn] nominal sensing distance	0.10 in (2.5 mm)
Discrete output function	1 NO
Output circuit type	DC
Discrete output type	NPN
Electrical connection	Cable
Cable length	6.56 ft (2 m)
[Us] rated supply voltage	12...24 V DC reverse polarity protection
Switching capacity in mA	<= 200 mA overload and short-circuit protection
IP degree of protection	IP65 conforming to IEC 60529 IP67 conforming to IEC 60529

## Complementary

Thread type	M8 x 1
Detection face	Frontal
Front material	PPS
Enclosure Material	Nickel Plated Brass
Operating zone	0.00...0.08 in (0...2 mm)
Differential travel	1...15% of Sr
Cable composition	3 x 0.11 mm <sup>2</sup>
Wire insulation material	PvR
Status LED	Output state 1 LED yellow)
Supply voltage limits	10...36 V DC
Switching frequency	<= 2500 Hz
Maximum voltage drop	<2 V (closed)
Current consumption	<= 10 mA no-load
Maximum delay first up	10 ms
Maximum delay response	0.2 ms
Maximum delay recovery	0.2 ms
Marking	CE
Threaded length	0.98 in (25 mm)
Length	1.30 in (33 mm)
Net Weight	0.15 lb(US) (0.07 kg)

## Environment

Product Certifications	UL CSA
Ambient Air Temperature for Operation	-13...158 °F (-25...70 °C)
Ambient Air Temperature for Storage	-40...185 °F (-40...85 °C)
Vibration resistance	25 gn +/- 2 mm 10...55 Hz)IEC 60068-2-6
Shock resistance	50 gn 11 ms IEC 60068-2-27

## Ordering and shipping details

Category	21571-SENSORS, ELECTRONIC BASIC XU & XS
Discount Schedule	DS2
GTIN	3389119036085
Nbr. of units in pkg.	1
Package weight(Lbs)	2.05 oz (58.0 g)
Returnability	No
Country of origin	FR

## Packing Units

Unit Type of Package 1	PCE
Package 1 Height	5.12 in (13 cm)
Package 1 width	1.69 in (4.3 cm)
Package 1 Length	3.74 in (9.5 cm)
Unit Type of Package 2	BAG
Number of Units in Package 2	1
Package 2 Weight	2.05 oz (58.0 g)
Package 2 Height	0.79 in (2 cm)
Package 2 width	7.87 in (20 cm)
Package 2 Length	5.91 in (15 cm)
Unit Type of Package 3	S02
Number of Units in Package 3	22
Package 3 Weight	3.82 lb(US) (1.731 kg)
Package 3 Height	5.91 in (15 cm)
Package 3 width	11.81 in (30 cm)
Package 3 Length	15.75 in (40 cm)

## Offer Sustainability

Sustainable offer status	Green Premium product
California proposition 65	WARNING: This product can expose you to chemicals including: Diisononyl phthalate (DINP), which is known to the State of California to cause cancer, and Di-isodecyl phthalate (DIDP), which is known to the State of California to cause birth defects or other reproductive harm. For more information go to <a href="http://www.P65Warnings.ca.gov">www.P65Warnings.ca.gov</a>
REACH Regulation	<a href="#">REACH Declaration</a>
EU RoHS Directive	Pro-active compliance (Product out of EU RoHS legal scope) <a href="#">EU RoHS Declaration</a>
Mercury free	Yes
RoHS exemption information	<a href="#">Yes</a>
Environmental Disclosure	<a href="#">Product Environmental Profile</a>
Circularity Profile	<a href="#">End Of Life Information</a>

## Contractual warranty

Warranty	18 months
----------	-----------

Dimensions

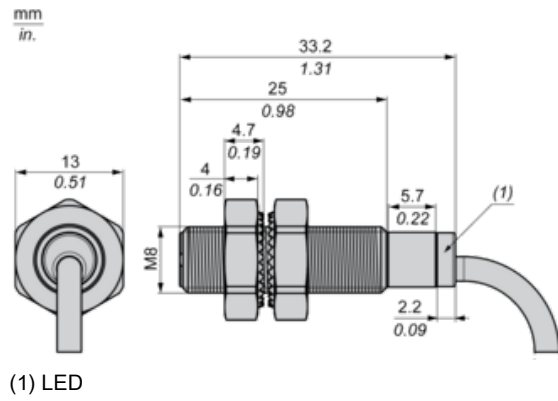

---

Minimum Mounting Distances in mm

---

Side by side

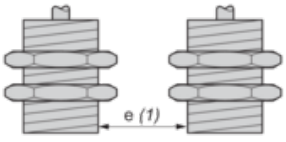

$e (1) \geq 5 \text{ mm}/0.20 \text{ in.}$

Face to face

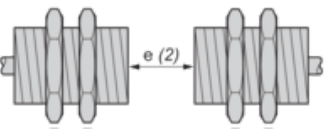

$e (2) \geq 30 \text{ mm}/1.18 \text{ in.}$

Facing a metal object

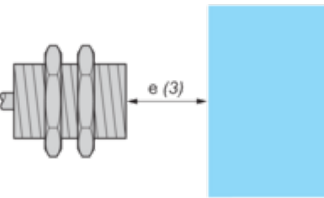

$e (3) \geq 8 \text{ mm}/0.31 \text{ in.}$

---

Mounting

---

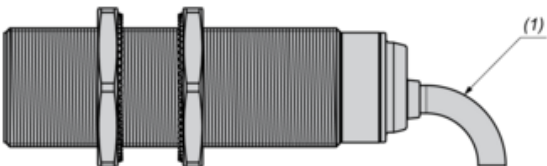

(1) Bending cable: 4 x external cable diameter

---

Wiring Schemes

---

NPN

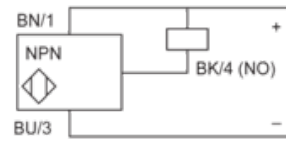

BU : Blue  
BN : Brown  
BK : Black

---

Performance Curves

---

Standard Steel Target (mm) : 8x8x1

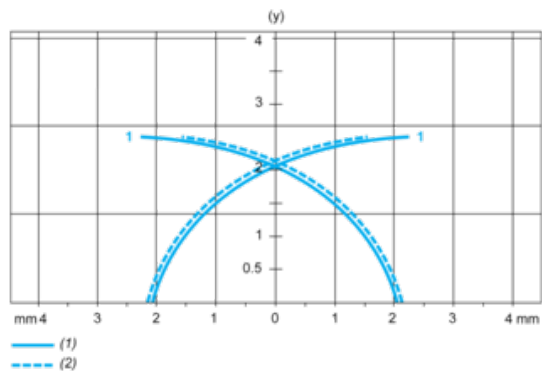

(1) Pick-up points

(2) Drop-out points (object approaching from the side)

(y) Sensing distance in mm