

● Description

The KTLP166J series consist of a GaAs infrared emitting diode optically coupled to a monolithic silicon detector performing the function of a zero voltage crossing bilateral TRIAC driver. They are designed for use with a TRIAC in the interface of logic systems to equipment powered from 115/240 VAC lines, such as solid-state relays, industrial controls, motors, solenoids and consumer appliances, etc.

● Features

1. Pb free and RoHS compliant
2. 600V peak blocking voltage
3. Subminiature type (The volume is smaller than that of our conventional DIP type by as far as 30%)
4. Simplifies logic control of 115/240 VAC power
5. Zero voltage crossing
6. Isolation voltage between input and output (Viso : 3750Vms)
7. MSL class 1
8. Agency Approvals :
 - UL Approved (No. E169586): UL1577
 - c-UL Approved (No. E169586)
 - VDE Approved (No. 40009235): DIN EN60747-5-5
 - CQC Approved: GB8898-2011, GB4943.1-2011

● Applications

- Solenoid/Valve controls
- Lighting controls
- Static power switches
- AC motor drives
- Temperature controls
- E.M contactors
- AC motor contactors
- Solid state relay
- Programmable controllers

● Schematic

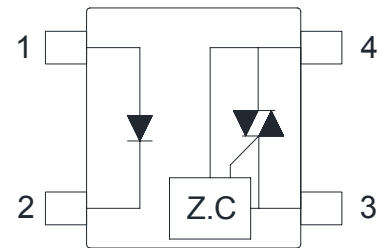

1. Anode
2. Cathode
3. Main terminal
4. Main terminal

● **Outside Dimension**

Unit : mm

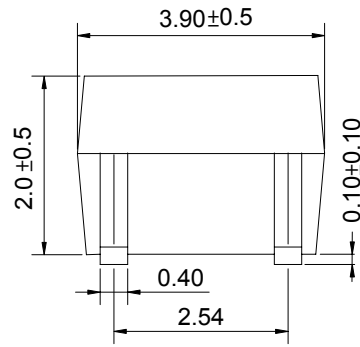
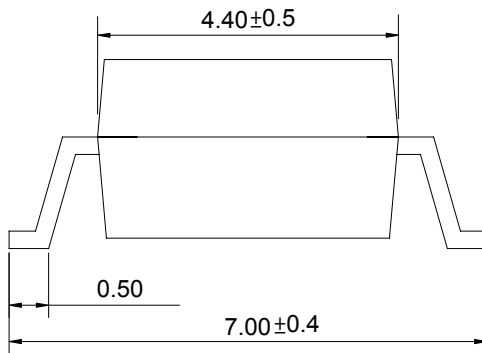
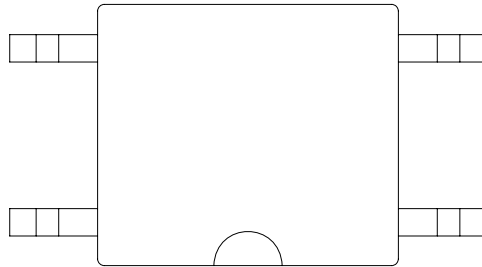

TOLERANCE : ±0.2mm

● **Device Marking**



Notes :

COSMO

166J

YWW

Y : Year code / W : Week code

● Absolute Maximum Ratings

(Ta=25°C)

Parameter		Symbol	Rating	Unit
Input	Forward current	I_F	50	mA
	Peak forward current	I_{FM}	1	A
	Reverse voltage	V_R	6	V
	Power dissipation	P_D	70	mW
Output	Off-state output terminal voltage	V_{DRM}	600	V_{PEAK}
	On-state R.M.S. current	$I_{T(RMS)}$	70	mA
	Peak repetitive surge current (PW=10ms.DC 10%)	I_{TSM}	1	A
	Power dissipation	P_D	150	mW
Total power dissipation		P_{tot}	200	mW
Isolation voltage 1 minute		V_{iso}	3750	Vrms
Operating temperature		T_{opr}	-40 to +115	°C
Storage temperature		T_{stg}	-50 to +125	°C
Soldering temperature 10 seconds		T_{sol}	260	°C

● Electro-optical Characteristics

(Ta=25°C)

Parameter		Symbol	Conditions	Min.	Typ.	Max.	Unit
Input	Forward voltage	V_F	$I_F=10mA$	-	1.2	1.4	V
	Reverse current	I_R	$V_R=4V$	-	-	10	μA
Output	Peak blocking current	I_{DRM}	V_{DRM} Rated	-	-	1	μA
	On-state voltage	V_{TM}	$I_{TM}=70mA$	-	1.8	3	V
Transfer characteristics	Holding current	I_H		-	0.1	-	mA
	Critical rate of rise of off-state voltage	dv/dt	$V_{DRM}=(1/\sqrt{2})*\text{Rated}$	1000	-	-	V/ μs
	Inhibit Voltage (MT1-MT2 Voltage above which device will not trigger)	V_{INH}	$I_F = \text{Rated } I_{FT}$	-	-	20	V
	Leakage in inhibited state	I_{DRM2}	$I_F = \text{Rated } I_{FT}, \text{ Rated } V_{DRM}, \text{ Off State}$	-	-	600	μA
	Isolation resistance	R_{iso}	DC500V	5×10^{10}	10^{11}	-	Ω
	Minimum trigger current	I_{FT}	Main terminal voltage=3V	-	-	10	mA

● Static dv/dt Test Circuit

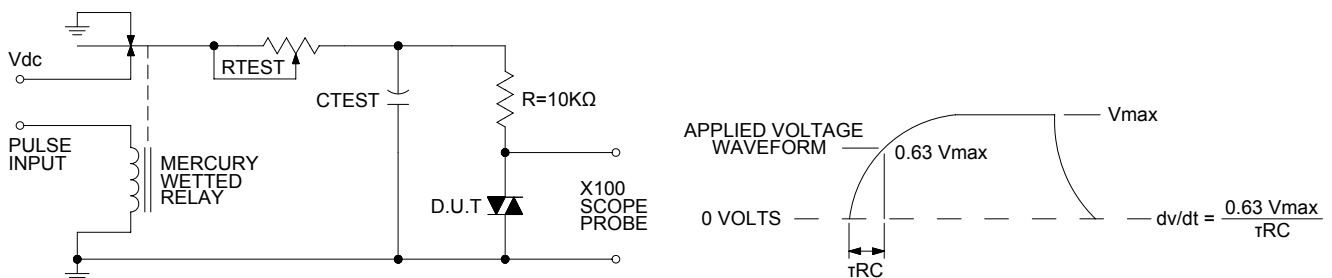

Fig.1 Forward Current vs. Ambient Temperature

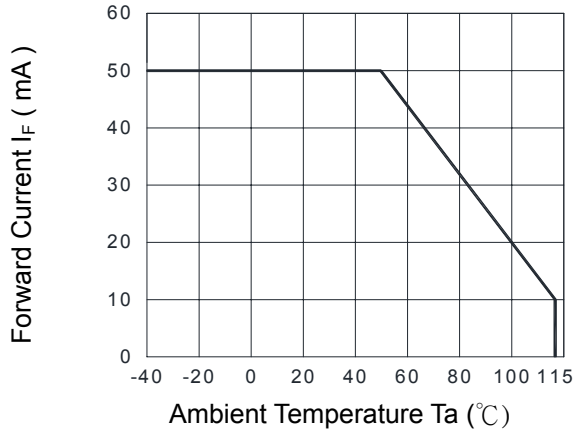

Fig.2 Diode Power Dissipation vs. Ambient Temperature

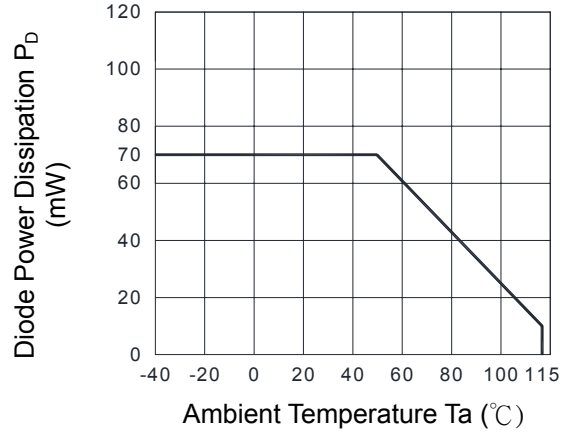

Fig.3 On-state R.M.S. Current vs. Ambient Temperature

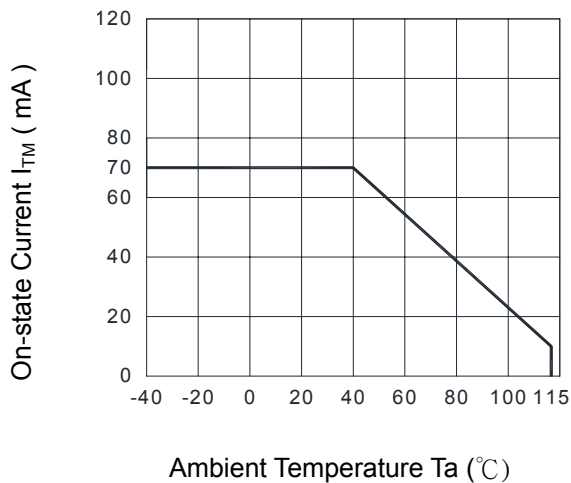

Fig.4 Total Power Dissipation vs. Ambient Temperature

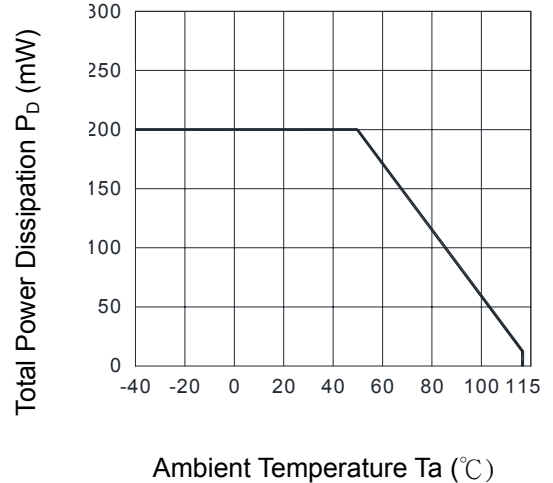

Fig.5 Peak Forward Current vs. Duty Ratio

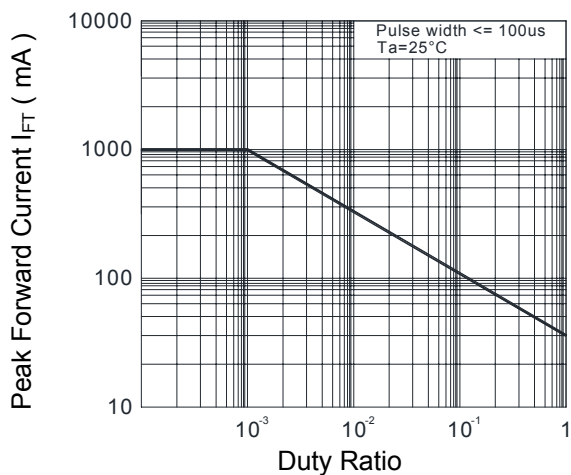

Fig.6 Forward Current vs. Forward Voltage

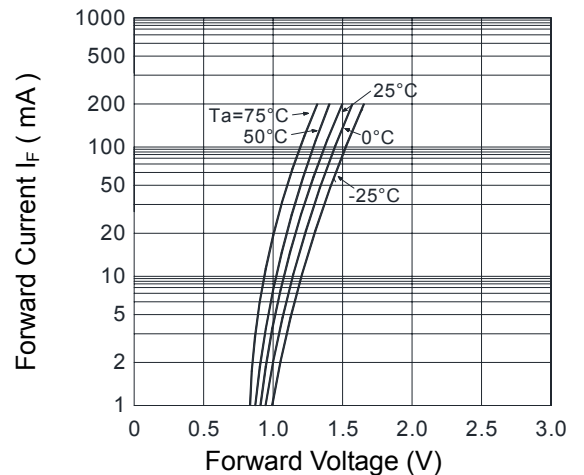

Fig.7 On-state Characteristics

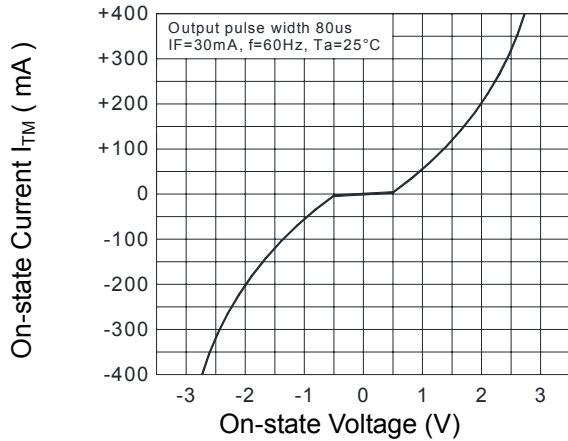

Fig.8 Inhibit Voltage vs. Ambient Temperature

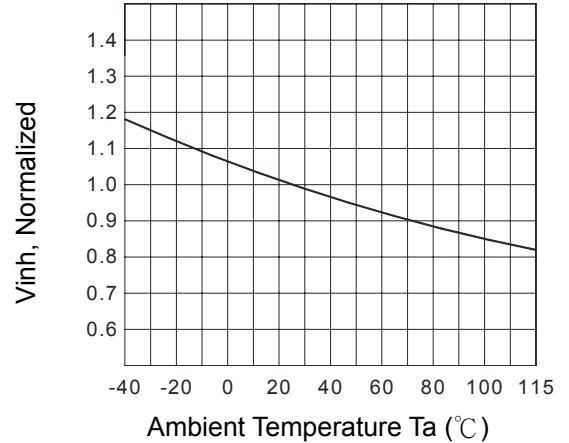

Fig.9 Leakage with LED off vs. Ambient Temperature

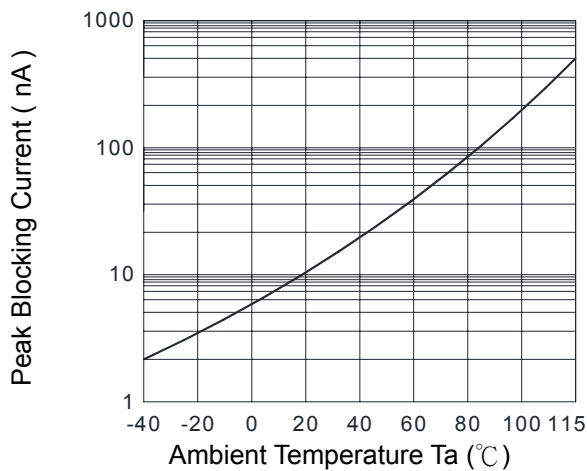

Fig.10 I_DRM2, Leakage in Inhibited State vs. Ambient Temperature

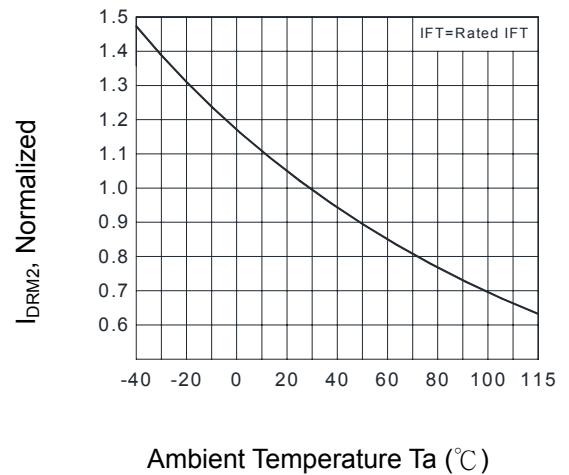
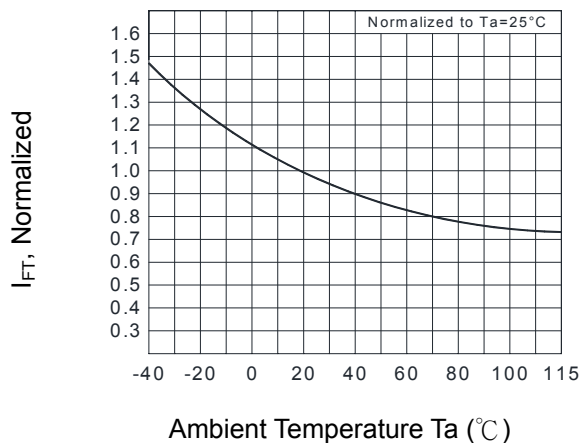

Fig.11 Trigger Current vs. Ambient Temperature



● Recommended Soldering Conditions

(a) Infrared reflow soldering :

- Peak reflow soldering : 260°C or below (package surface temperature)
- Time of peak reflow temperature : 10 sec
- Time of temperature higher than 230°C : 30-60 sec
- Time to preheat temperature from 180~190°C : 60-120 sec
- Time(s) of reflow : Two
- Flux : Rosin flux containing small amount of chlorine (The flux with a maximum chlorine content of 0.2 Wt% is recommended.)

Recommended Temperature Profile of Infrared Reflow

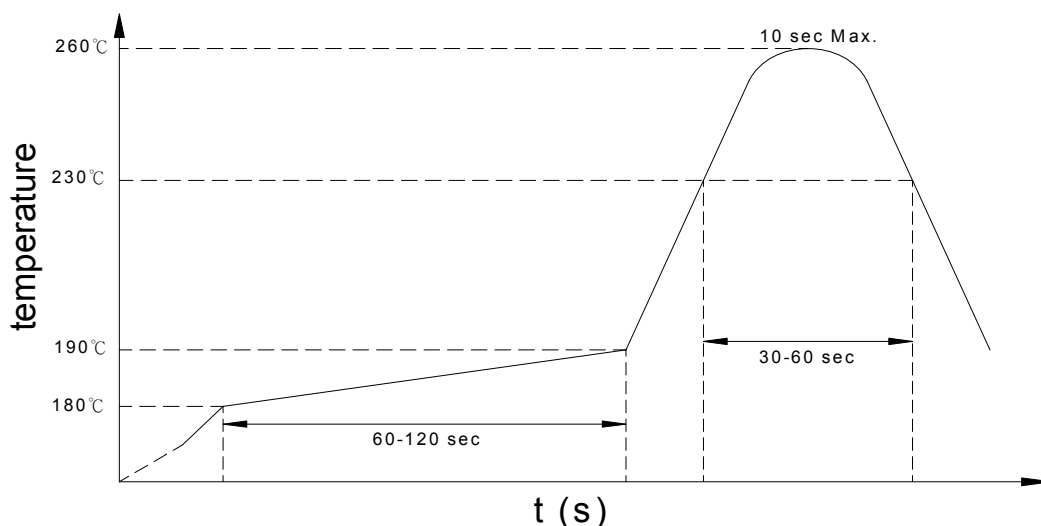

(b) Wave soldering :

- Temperature : 260°C or below (molten solder temperature)
- Time : 10 seconds or less
- Preheating conditions : 120°C or below (package surface temperature)
- Time(s) of reflow : One
- Flux : Rosin flux containing small amount of chlorine (The flux with a maximum chlorine content of 0.2 Wt% is recommended.)

(c) Cautions :

- Fluxes : Avoid removing the residual flux with freon-based and chlorine-based cleaning solvent.
- Avoid shorting between portion of frame and leads.

● **Numbering System**

KTLP166J (X)

Notes :

KTLP166J = Part No.

X = Tape and reel option (TLD 、 TRU)

Option	Description	Packing quantity
TLD	surface mount type package + TLD tape & reel option	3000 units per reel
TRU	surface mount type package + TRU tape & reel option	3000 units per reel

● **Recommended Pad Layout for Surface Mount Lead Form**

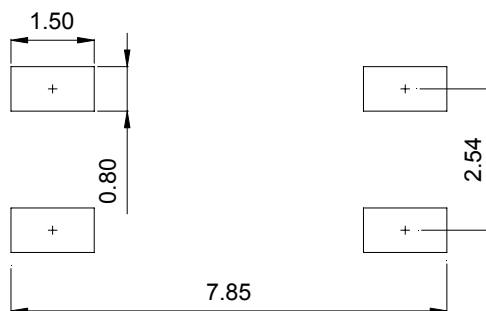
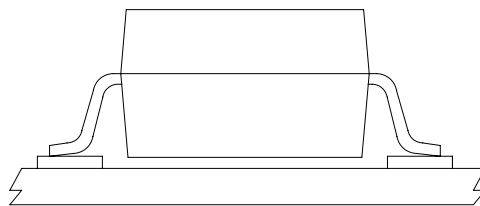

Unit : mm

● 4-pin Mini-Flat TLD/TRU Carrier Tape & Reel

Unit : mm

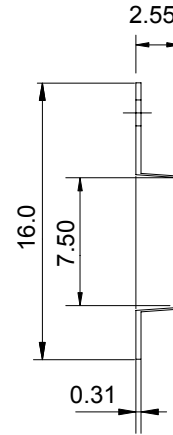
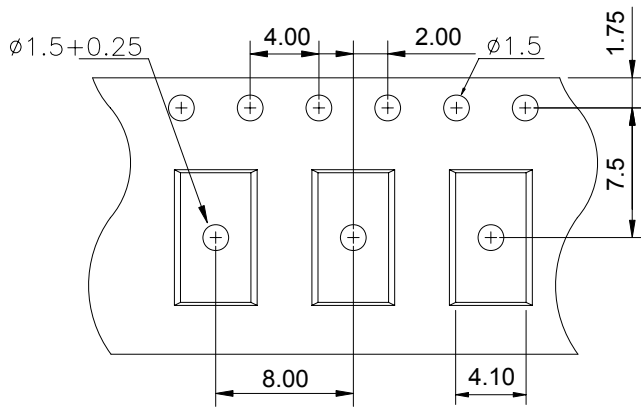

TOLERANCE : $\pm 0.2\text{mm}$

TLD

TRU

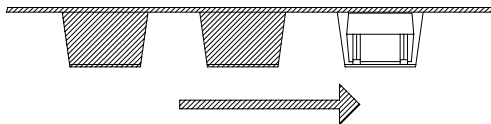
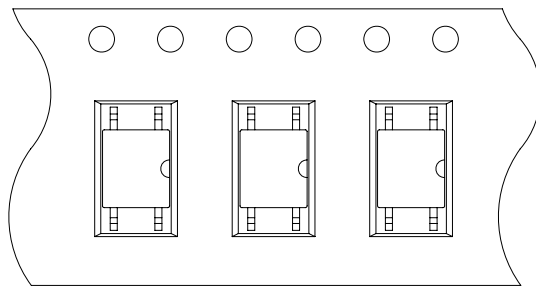
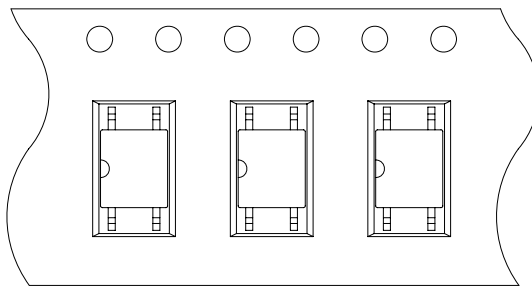

Direction of feed from reel

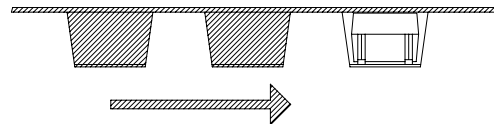

Direction of feed from reel

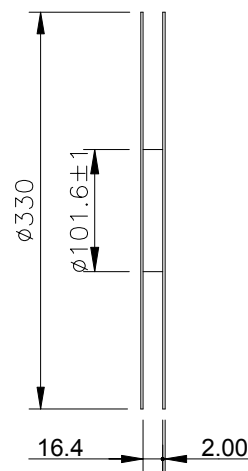
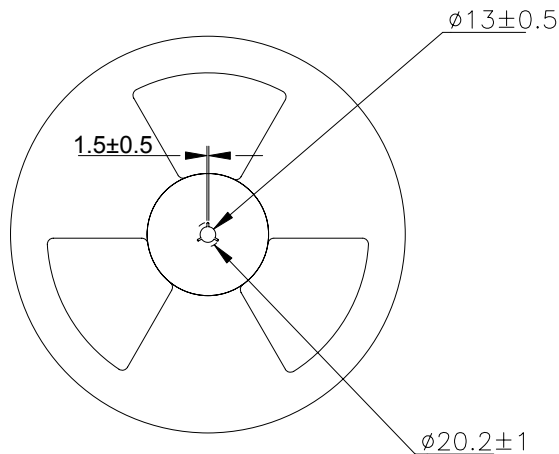



● Application Notice

The statements regarding the suitability of products for certain types of applications are based on cosmo's knowledge of general applications of cosmo products. Such statements are not binding statements about the suitability of products for a particular application. It is the customer's responsibility to verify the specifications are suitable for use in a particular application. Customers are solely responsible for all aspects of their own product design or applications. The parameters provided in the datasheet may vary in different applications and performance may vary over time. All operating parameters (including typical parameters) must be validated by customer's technical experts for different applications. cosmo assumes no liability for customer' product design or applications. Product specifications do not expand or otherwise change cosmo's terms and conditions of purchase, including but not limited to the warranty expressed therein.

When using cosmo products, please comply with safety standards and instructions. cosmo has no liability and responsibility to the damage caused by improper use of the instructions specified in the specifications.

cosmo products are designed for use in general electronic equipment such as telecommunications, office automation equipments, personal computers, test and measurement equipments, consumer electronics, industrial control, instrumentation, audio, video.

cosmo devices shall not be used in equipment that requires higher level of reliability and safety, such as nuclear power control equipment, telecommunication equipment(trunk lines), space application, medical and other life supporting equipments, and equipment for aircraft, military, automotive or any other application that can cause human injury or death.

cosmo reserves the right to change the specifications, data, characteristics, structure, materials and other contents at any time without notice. Please contact cosmo to obtain the latest specification.

cosmo disclaim any and all liability for any errors, inaccuracies or incompleteness contained in any datasheet or in any other disclosure relating to any product.