

Z0103MN, Z0107MN, Z0109MN

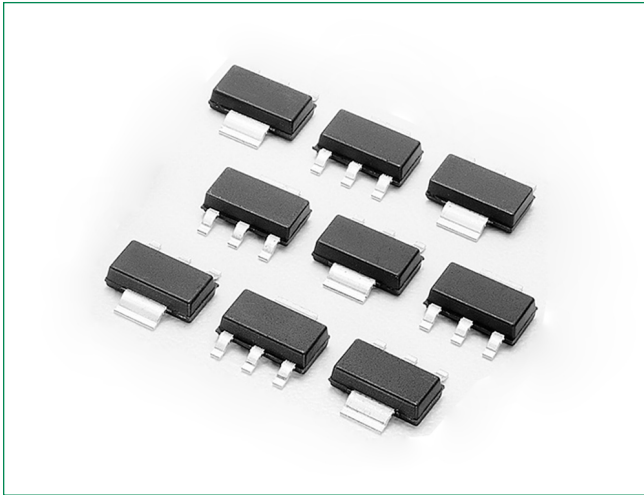

Description

Designed for use in solid state relays, MPU interface, TTL logic and other light industrial or consumer applications. Supplied in surface mount package for use in automated manufacturing.

Features

- Sensitive Gate Trigger Current in Four Trigger Modes
- Blocking Voltage to 600 V
- Glass Passivated Surface for Reliability and Uniformity
- Surface Mount Package
- These are Pb-Free Devices

Pin Out

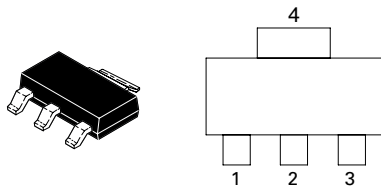

Functional Diagram

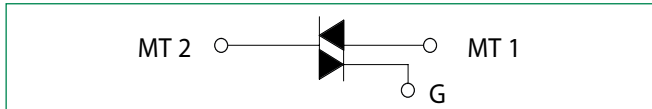

Additional Information



Datasheet



Resources



Samples

Maximum Ratings ($T_J = 25^\circ\text{C}$ unless otherwise noted)

Rating	Symbol	Value	Unit
Peak Repetitive Off-State Voltage (Note 1) ($R_{GK} = I_K, T_J = -40$ to $+125^\circ\text{C}$, Sine Wave, 50 to 60 Hz)	V_{DRM}^* V_{RRM}	600	V
On-State RMS Current (Full Sine Wave 50 to 60 Hz; $T_C = 80^\circ\text{C}$)	$I_T (RMS)$	1.0	A
Peak Non-repetitive Surge Current (One Full Cycle Sine Wave, 60 Hz, $T_C = 25^\circ\text{C}$)	$I_T (RMS)$	8.0	A
Circuit Fusing Considerations ($t = 8.3$ ms)	I^2t	0.4	A ² s
Average Gate Power ($T_C = 80^\circ\text{C}$, $t \leq 8.3$ ms)	$P_{G(AV)}$	1.0	W
Peak Gate Current ($t \leq 20$ s, $T_J = +125^\circ\text{C}$)	I_{GM}	1.0	A
Operating Junction Temperature Range @ Rated V_{RRM} and V_{DRM}	T_J	-40 to +110	$^\circ\text{C}$
Storage Temperature Range	T_{stg}	-40 to +150	$^\circ\text{C}$

Thermal Characteristics

Rating	Symbol	Value	Unit
Thermal Resistance, Junction-to-Ambient PCB Mounted per Figure 1	$R_{\theta JA}$	156	$^\circ\text{C/W}$
Thermal Resistance, Junction-to-Tab Measured on MT2 Tab Adjacent to Epoxy	$R_{\theta JT}$	25	$^\circ\text{C/W}$
Maximum Device Temperature for Soldering Purposes for 10 Secs Maximum	T_L	260	$^\circ\text{C}$

Stresses exceeding Maximum Ratings may damage the device. Maximum Ratings are stress ratings only. Functional operation above the Recommended Operating Conditions is not implied. Extended exposure to stresses above the Recommended Operating Conditions may affect device reliability.

- V_{DRM} and V_{RRM} for all types can be applied on a continuous basis. Ratings apply for zero or negative gate voltage; however, positive gate voltage shall not be applied concurrent with negative potential on the anode. Blocking voltages shall not be tested with a constant current source such that the voltage ratings of the devices are exceeded.

Electrical Characteristics - OFF ($T_J = 25^\circ\text{C}$ unless otherwise noted)

Characteristic		Symbol	Min	Typ	Max	Unit
Peak Repetitive Forward or Reverse Blocking Current (Note 3) ($V_{AK} = \text{Rated } V_{DRM} \text{ or } V_{RRM}, R_{GK} = 1000 \text{ k}\Omega$)	$T_J = 25^\circ\text{C}$	I_{DRM}^*	-	-	5.0	μA
	$T_J = 125^\circ\text{C}$		-	-	500	

Electrical Characteristics - ON ($T_J = 25^\circ\text{C}$ unless otherwise noted; Electricals apply in both directions)

Characteristic	Symbol	Min	Typ	Max	Unit
Peak On-State Voltage ($I_{TM} = \pm 11$ A Peak, Pulse Width ≤ 2 ms, Duty Cycle $\leq 2\%$)	V_{TM}	–	–	1.8	V
Z0103MN Gate Trigger Current (Continuous dc) ($V_D = 12$ V, $R_L = 30$ Ohms)	MT2(+), G(+)	0.15	–	3.0	mA
	MT2(+), G(–)	0.15	–	3.0	
	MT2(–), G(–)	0.15	–	3.0	
	MT2(–), G(+)	0.25	–	5.0	
Z0107MN Gate Trigger Current (Continuous dc) ($V_D = 12$ V, $R_L = 30$ Ohms)	MT2(+), G(+)	0.15	–	5.0	mA
	MT2(+), G(–)	0.15	–	5.0	
	MT2(–), G(–)	0.15	–	5.0	
	MT2(–), G(+)	0.25	–	7.0	
Z0109MN Gate Trigger Current (Continuous dc) ($V_D = 12$ V, $R_L = 30$ Ohms)	MT2(+), G(+)	0.15	–	10	mA
	MT2(+), G(–)	0.15	–	10	
	MT2(–), G(–)	0.15	–	10	
	MT2(–), G(+)	0.25	–	10	
Z0103MN Latching Current ($V_D = 12$ V, $I_G = 1.2 \times I_{GT}$) ALL TYPES	MT2(+), G(+)	–	–	7.0	mA
	MT2(+), G(–)	–	–	15	
	MT2(–), G(–)	–	–	7.0	
	MT2(–), G(+)	–	–	7.0	
Z0107MN Latching Current ($V_D = 12$ V, $I_G = 1.2 \times I_{GT}$) ALL TYPES	MT2(+), G(+)	–	–	10	mA
	MT2(+), G(–)	–	–	20	
	MT2(–), G(–)	–	–	10	
	MT2(–), G(+)	–	–	10	
Z0109MN Latching Current ($V_D = 12$ V, $I_G = 1.2 \times I_{GT}$) ALL TYPES	MT2(+), G(+)	–	–	15	mA
	MT2(+), G(–)	–	–	25	
	MT2(–), G(–)	–	–	15	
	MT2(–), G(+)	–	–	15	

Electrical Characteristics - ON ($T_J = 25^\circ\text{C}$ unless otherwise noted; Electricals apply in both directions) Continued

Gate Trigger Voltage (Continuous dc) ($V_D = 12$ Vdc, $R_L = 30$ Ohms)	V_{GT}	–	–	1.3	V
Gate-Controlled Turn-On Time, ($V_D = \text{Rated } V_{DRM}$, $I_{TM} = 16$ A Peak, $I_G = 30$ mA)	t_{gt}	0.2	–	10	μs

Dynamic Characteristics

Characteristic	Symbol	Min	Typ	Max	Unit
Rate of Change of Commutating Current ($V_D = 400\text{ V}$, $I_{TM} = 0.84\text{ A}$, Commutating $dv/dt = 1.5\text{ V}/\mu\text{s}$, Gate Open, $T_J = 110^\circ\text{C}$, $f = 250\text{ Hz}$, with Snubber)	dv/dt	1.6	-	-	A/ms
Critical Rate of Rise of On-State Current ($T_C = 110^\circ\text{C}$, $I_G = 2 \times I_{GT}$, $R_{GK} = 1\text{ k}\Omega$)	Z0103MN	10	30	-	V/ μs
	Z0107MN	20	60	-	
	Z0109MN	50	75	-	
Repetitive Critical Rate of Rise of On-State Current, $T_J = 125^\circ\text{C}$ Pulse Width = 20 μs , $IPK_{max} = 15\text{ A}$, $di/dt = 1\text{ A}/\mu\text{s}$, $f = 60\text{ Hz}$		-	-	20	A/ μs

Voltage Current Characteristic of SCR

Symbol	Parameter
V_{DRM}	Peak Repetitive Forward Off State Voltage
I_{DRM}	Peak Forward Blocking Current
V_{RRM}	Peak Repetitive Reverse Off State Voltage
I_{RRM}	Peak Reverse Blocking Current
V_{TM}	Maximum On State Voltage
I_H	Holding Current

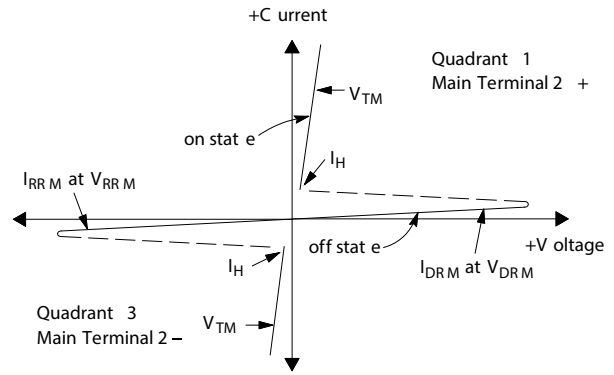

Quadrant Definitions for a Triac

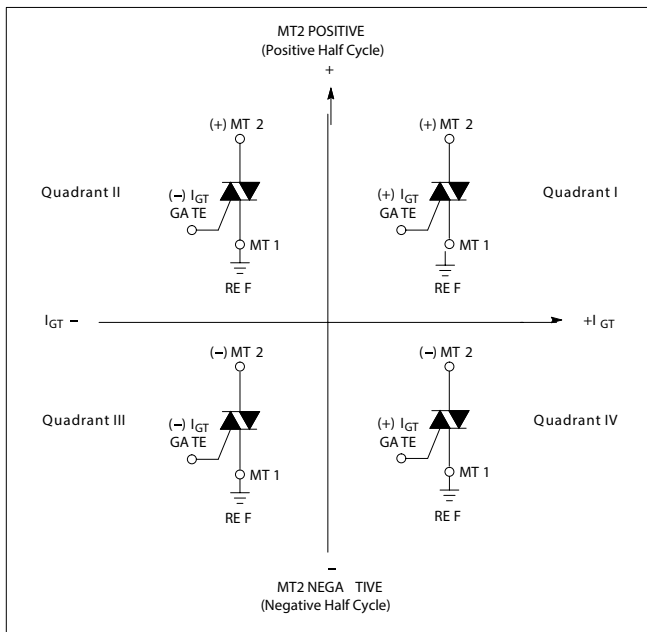

All polarities are referenced to MT1.
With in-phase signals (using standard AC lines) quadrants I and III are used

Figure 1. PCB for Thermal Impedance and Power Testing of SOT-223

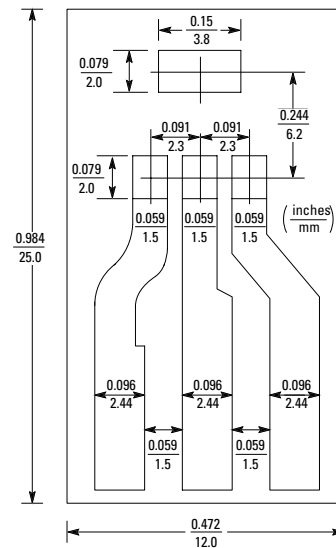

BOARD MOUNTED VERTICALLY IN CINCH 8840 EDGE CONNECTOR,
BOARD THICKNESS = 65 MIL., FOIL THICKNESS = 2.5 MIL.
MATERIAL: G10 FIBERGLASS BASE EPOXY

Figure 2. On-State Characteristics

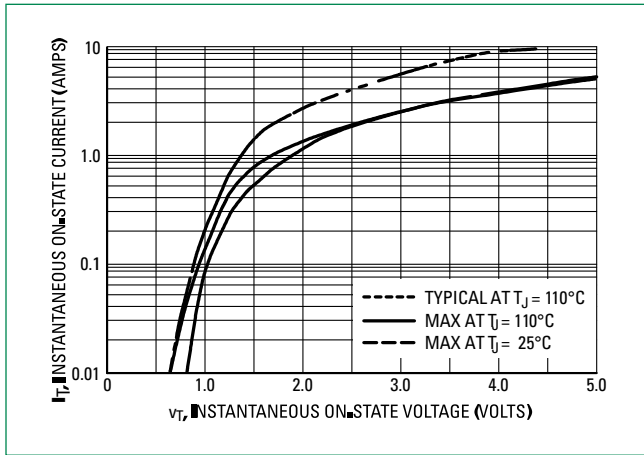

Figure 3. Junction to Ambient Thermal Resistance vs Copper Tab Area

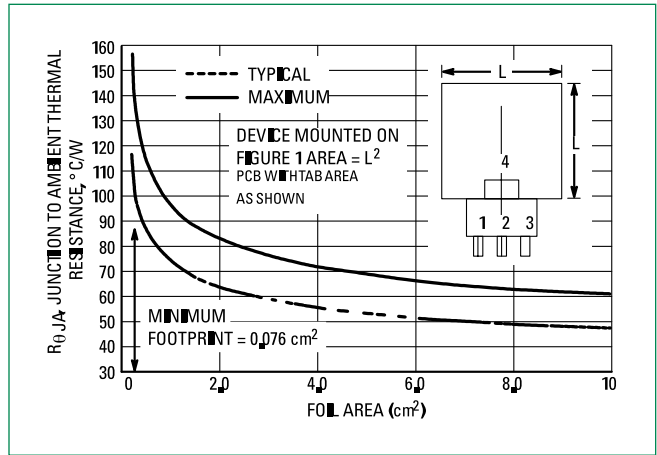

Figure 4. Current Derating, Minimum Pad Size Reference: Ambient Temperature

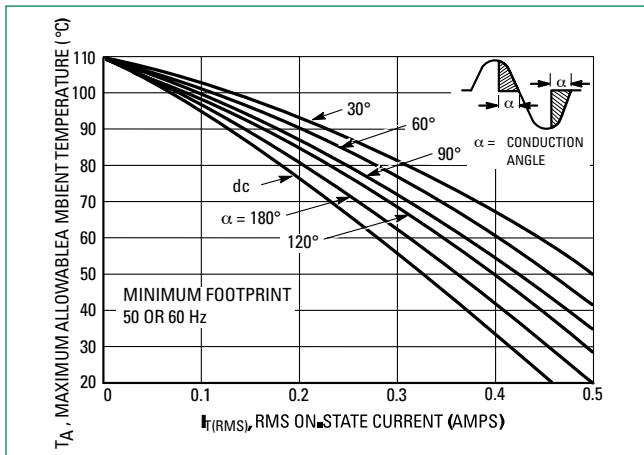

Figure 5. Current Derating, 1.0 cm Square Pad Reference: Ambient Temperature

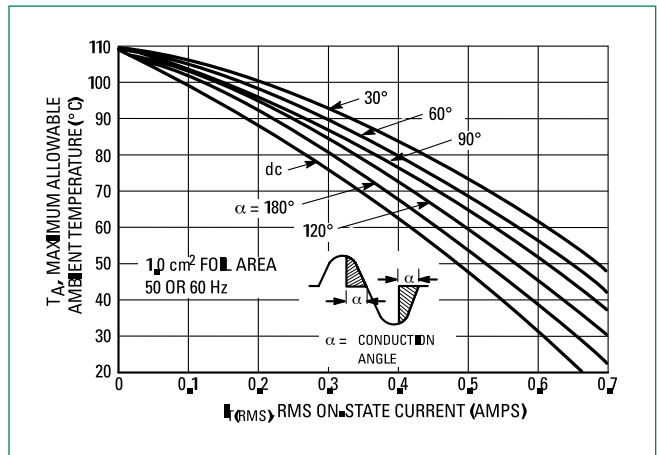

Figure 6. Current Derating, 2.0 cm Square Pad Reference: Ambient Temperature

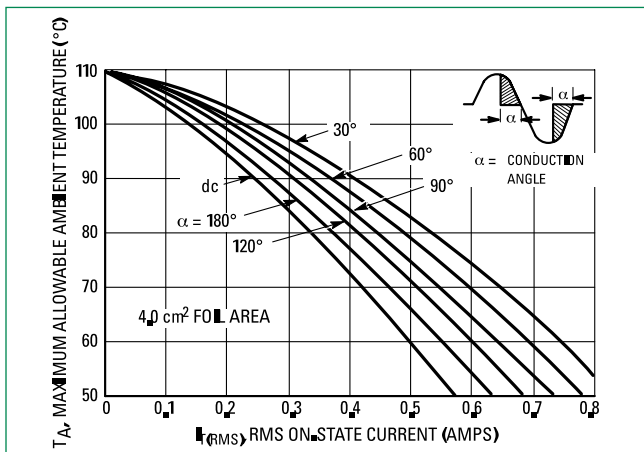

Figure 7. Current Derating Reference: MT2 Tab

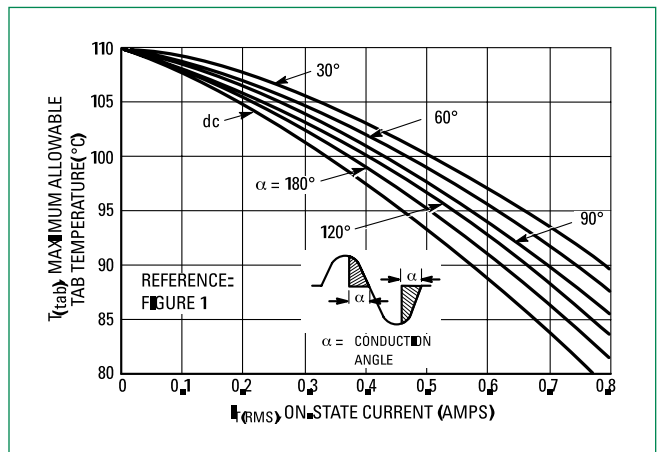

Figure 8. Power Dissipation

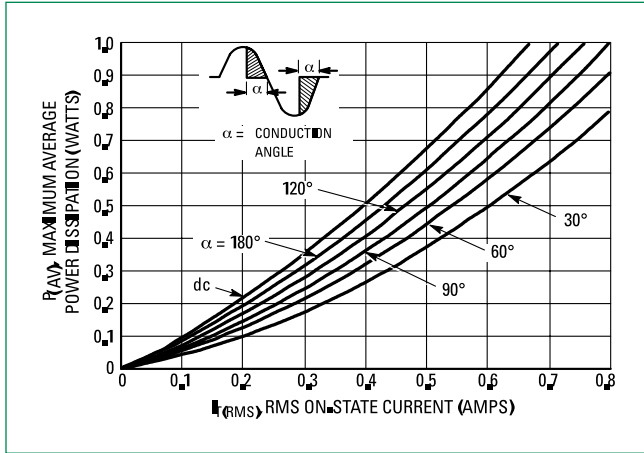

Figure 9. Thermal Response, Device Mounted on Figure 1 Printed Circuit Board

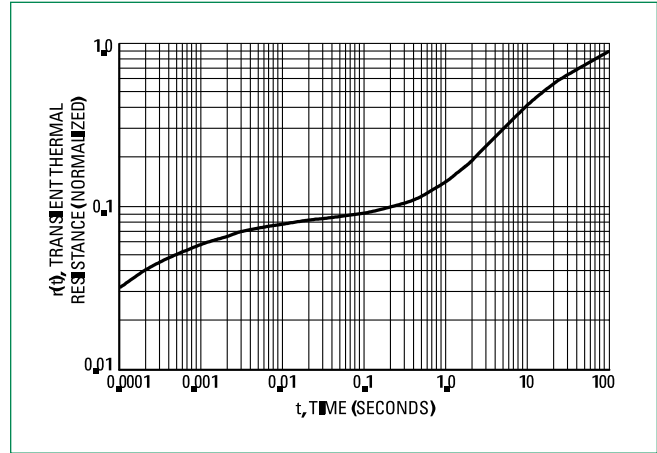

Figure 10. Simplified Test Circuit to Measure the Critical Rate of Rise of Commutating Voltage (dv/dt)_c

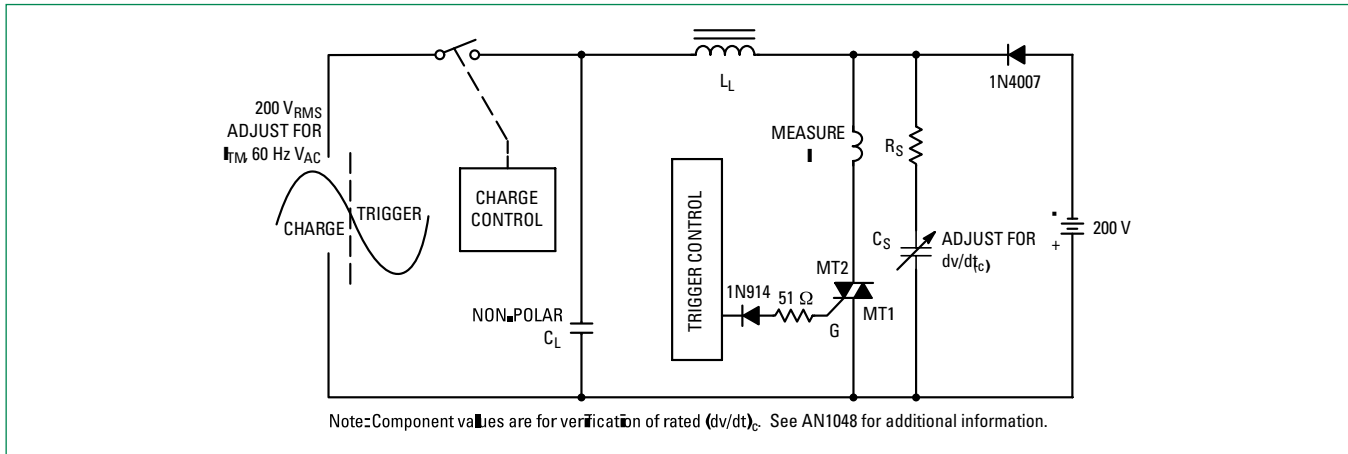

Figure 11. Typical Commutating dv/dt vs Current Crossing Rate and Junction Temperature

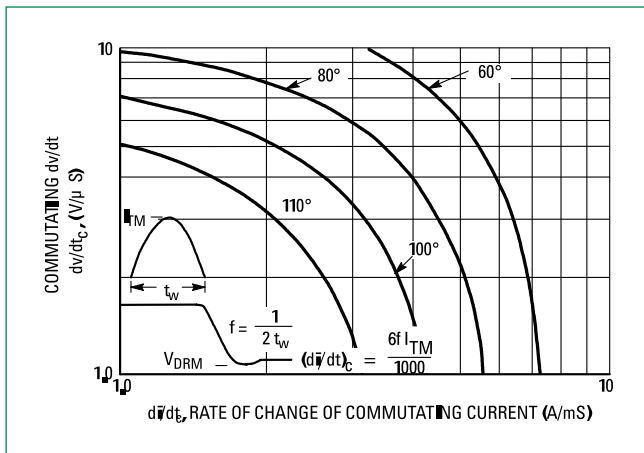

Figure 12. Typical Commutating dv/dt vs Junction Temperature at 0.8 Amps RMS

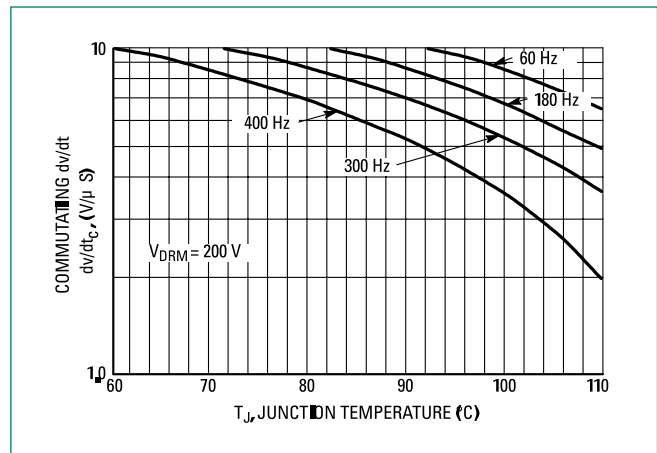

Figure 13. Exponential Static dv/dt versus Gate – Main Terminal 1 Resistance

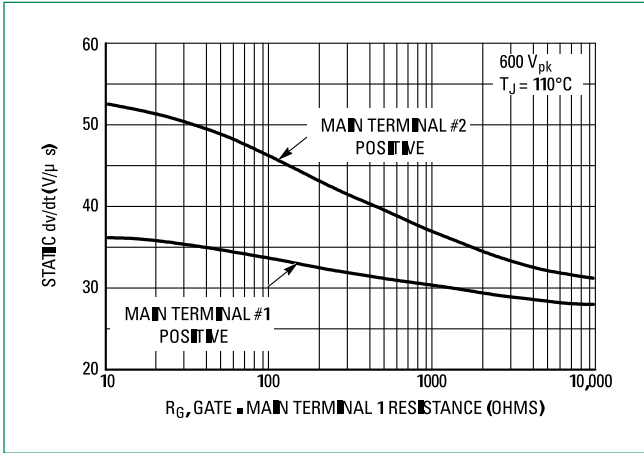

Figure 14. Typical Gate Trigger Current Variation

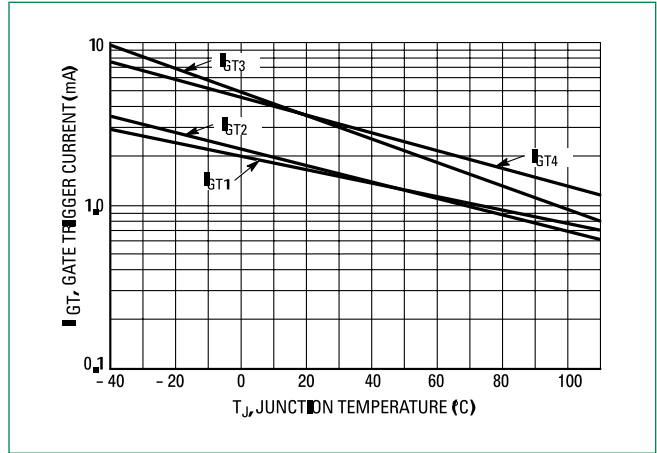

Figure 15. Typical Holding Current Variation

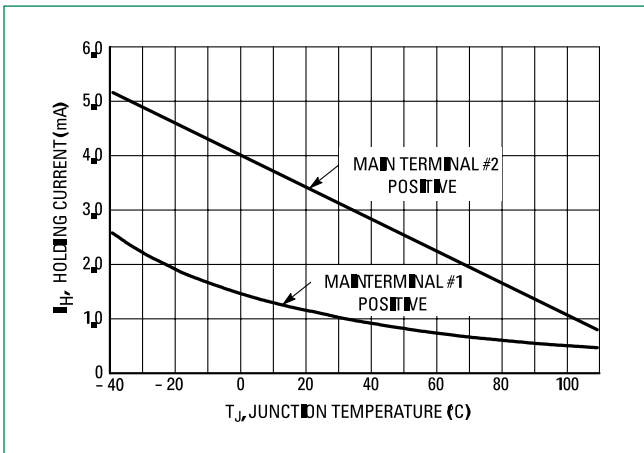
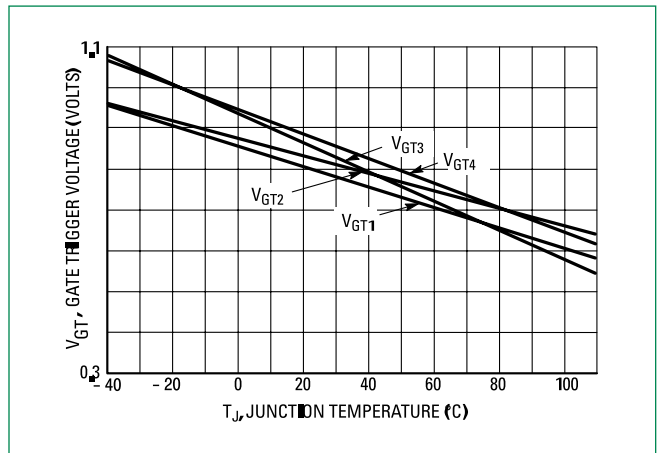
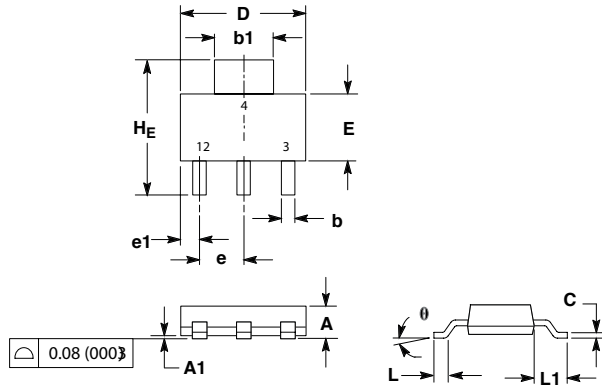

Figure 16. Gate Trigger Voltage Variation



Dimensions



Soldering Footprint

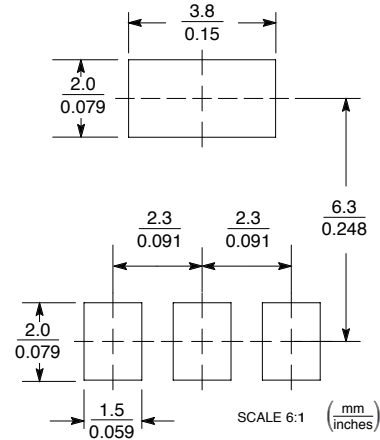

Dim	Inches			Millimeters		
	Min	Nom	Max	Min	Nom	Max
A	---	---	0.071	---	---	1.80
A1	0.001	0.003	0.005	0.02	0.07	0.13
b	0.026	0.030	0.033	0.66	0.75	0.84
b1	0.114	0.118	0.122	2.90	3.00	3.10
c	0.009	0.011	0.014	0.23	0.29	0.35
D	0.260	0.260	0.264	6.60	6.60	6.71
E	0.130	0.138	0.146	3.30	3.50	3.70
e	---	0.091	---	---	2.30	---
e1	0.030	0.037	0.045	0.75	0.95	1.15
L1	0.059	0.069	0.079	1.50	1.75	2.00
HE	0.268	0.276	0.283	6.80	7.00	7.20
∅	0°	---	10°	0°	---	10°

1. DIMENSIONING AND TOLERANCING PER ANSI Y14.5M, 1982.
2. CONTROLLING DIMENSION: INCH.

Ordering Information

Device	Package	Shipping
Z0103MNT1G	SOT-223 (Pb-Free)	1000 / Tape & Reel
Z0107MNT1G	SOT-223 (Pb-Free)	
Z0109MNT1G	SOT-223 (Pb-Free)	

Part Marking System

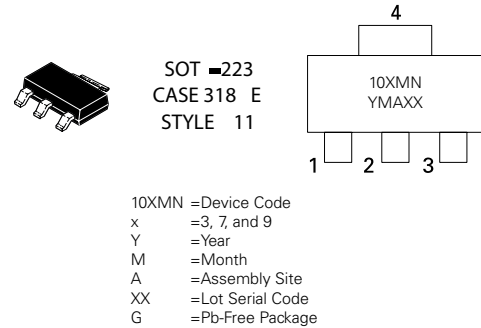

(Note: Microdot may be in either location)

Pin Assignment

Pin	Assignment
1	Main Terminal 1
2	Main Terminal 2
3	Gate
4	Main Terminal 2

Disclaimer Notice - Information furnished is believed to be accurate and reliable. However, users should independently evaluate the suitability of and test each product selected for their own applications. Littelfuse products are not designed for, and may not be used in, all applications. Read complete Disclaimer Notice at: www.littelfuse.com/disclaimer-electronics