



# WTS26P-34161120A00

W26

COMPACT PHOTOELECTRIC SENSORS

**SICK**  
Sensor Intelligence.



Illustration may differ

### Ordering information

| Type               | Part no. |
|--------------------|----------|
| WTS26P-34161120A00 | 1218949  |

Other models and accessories → [www.sick.com/W26](http://www.sick.com/W26)



### Detailed technical data

#### Features

|  |  |
|--|--|
| <b>Sensor/ detection principle</b>     | Photoelectric proximity sensor, Background suppression<br>TwinEye technology |
| <b>Dimensions (W x H x D)</b>          | 24.6 mm x 82.5 mm x 53.3 mm  |
| <b>Housing design (light emission)</b> | Rectangular  |
| <b>Sensing range max.</b>              | 10 mm ... 1,000 mm <sup>1)</sup>   |
| <b>Type of light</b>                   | Visible red light  |
| <b>Light source</b>                    | PinPoint LED <sup>2)</sup>   |
| <b>Light spot size (distance)</b>      | Ø 10 mm (550 mm)   |
| <b>Wave length</b>                     | 635 nm   |
| <b>Adjustment</b>                      |  |
| Teach-Turn adjustment                  | BluePilot: for setting the sensing range                                     |
| IO-Link                                | For configuring the sensor parameters and Smart Task functions               |
| <b>Indication</b>                      |  |
| LED indicator blue                     | BluePilot: sensing range indicator   |
| LED indicator green                    | Operating indicator<br>Static: power on<br>Flashing: IO-Link mode            |

<sup>1)</sup> Object with 90 % reflectance (referred to standard white, DIN 5033).

<sup>2)</sup> Average service life: 100,000 h at T<sub>U</sub> = +25 °C.

|                             |  |
|-----------------------------|--|
| LED indicator yellow        | Status of received light beam<br>Static on: object present<br>Static off: object not present |
| <b>Pin 2 configuration</b>  | External Input (test), Teach-in, switching signal  |
| <b>Special applications</b> | Detecting uneven, shiny objects, Detecting objects wrapped in film                           |

<sup>1)</sup> Object with 90 % reflectance (referred to standard white, DIN 5033).

<sup>2)</sup> Average service life: 100,000 h at  $T_U = +25 \text{ }^\circ\text{C}$ .

## Mechanics/electronics

|  |   |
|--|---|
| <b>Supply voltage</b>                  | 10 V DC ... 30 V DC <sup>1)</sup>   |
| <b>Ripple</b>                          | < 5 V <sub>pp</sub>   |
| <b>Current consumption</b>             | 30 mA <sup>2)</sup><br>50 mA <sup>3)</sup>  |
| <b>Switching output</b>                | Push-pull: PNP/NPN  |
| <b>Output: QL1 / C</b>                 | Switching output or IO-Link mode  |
| <b>Output function</b>                 | Factory setting: Pin 2 / white (MF): NPN normally open (light switching), PNP normally closed (dark switching), Pin 4 / black (QL1 / C): NPN normally closed (dark switching), PNP normally open (light switching), IO-Link |
| <b>Switching mode</b>                  | Light/dark switching  |
| <b>Signal voltage PNP HIGH/LOW</b>     | Approx. $V_S - 2.5 \text{ V} / 0 \text{ V}$   |
| <b>Signal voltage NPN HIGH/LOW</b>     | Approx. $V_S / < 2.5 \text{ V}$   |
| <b>Output current I<sub>max.</sub></b> | ≤ 100 mA  |
| <b>Response time</b>                   | ≤ 1.4 ms <sup>4)</sup>  |
| <b>Switching frequency</b>             | 350 Hz <sup>5)</sup>  |
| <b>Connection type</b>                 | Cable with M12 male connector, 4-pin, 270 mm <sup>6)</sup>  |
| <b>Cable material</b>                  | PVC   |
| <b>Circuit protection</b>              | A <sup>7)</sup><br>B <sup>8)</sup><br>C <sup>9)</sup><br>D <sup>10)</sup>   |
| <b>Protection class</b>                | III   |
| <b>Weight</b>                          | 100 g   |
| <b>Housing material</b>                | Plastic, VISTAL®  |
| <b>Optics material</b>                 | Plastic, PMMA   |
| <b>Enclosure rating</b>                | IP66 (According to EN 60529)<br>IP67 (According to EN 60529)  |

<sup>1)</sup> Limit values.

<sup>2)</sup> 16 V DC ... 30 V DC, without load.

<sup>3)</sup> 10 V DC ... 16 V DC, without load.

<sup>4)</sup> Signal transit time with resistive load in switching mode. Different values possible in COM2 mode.

<sup>5)</sup> With light/dark ratio 1:1 in switching mode. Different values possible in IO-Link mode.

<sup>6)</sup> Do not bend below 0 °C.

<sup>7)</sup> A = V<sub>S</sub> connections reverse-polarity protected.

<sup>8)</sup> B = inputs and output reverse-polarity protected.

<sup>9)</sup> C = interference suppression.

<sup>10)</sup> D = outputs overcurrent and short-circuit protected.

<sup>11)</sup> Replaces IP69K with ISO 20653: 2013-03.

|                                      |   |
|--------------------------------------|---|
|                                      | IP69 (According to EN 60529) <sup>11)</sup> |
| <b>Ambient operating temperature</b> | -40 °C ... +60 °C                           |
| <b>Ambient temperature, storage</b>  | -40 °C ... +75 °C                           |
| <b>UL File No.</b>                   | NRKH.E181493 & NRKH7.E181493                |

<sup>1)</sup> Limit values.

<sup>2)</sup> 16 V DC ... 30 V DC, without load.

<sup>3)</sup> 10 V DC ... 16 V DC, without load.

<sup>4)</sup> Signal transit time with resistive load in switching mode. Different values possible in COM2 mode.

<sup>5)</sup> With light/dark ratio 1:1 in switching mode. Different values possible in IO-Link mode.

<sup>6)</sup> Do not bend below 0 °C.

<sup>7)</sup> A = V<sub>S</sub> connections reverse-polarity protected.

<sup>8)</sup> B = inputs and output reverse-polarity protected.

<sup>9)</sup> C = interference suppression.

<sup>10)</sup> D = outputs overcurrent and short-circuit protected.

<sup>11)</sup> Replaces IP69K with ISO 20653: 2013-03.

### Safety-related parameters

|                         |           |
|-------------------------|-----------|
| <b>MTTF<sub>D</sub></b> | 415 years |
| <b>DC<sub>avg</sub></b> | 0 %       |

### Communication interface

|                                       |  |
|---------------------------------------|--|
| <b>Communication interface</b>        | IO-Link V1.1   |
| <b>Communication Interface detail</b> | COM2 (38,4 kBaud)  |
| <b>Cycle time</b>                     | 2.3 ms   |
| <b>Process data length</b>            | 16 Bit   |
| <b>Process data structure</b>         | Bit 0 = switching signal Q <sub>L1</sub><br>Bit 1 = switching signal Q <sub>L2</sub><br>Bit 2 ... 15 = empty |
| <b>VendorID</b>                       | 26   |
| <b>DeviceID HEX</b>                   | 0x80017C   |
| <b>DeviceID DEC</b>                   | 8388988  |

### Smart Task

|                            |  |
|----------------------------|--|
| <b>Smart Task name</b>     | Base logics  |
| <b>Logic function</b>      | Direct<br>AND<br>OR<br>Window<br>Hysteresis  |
| <b>Timer function</b>      | Deactivated<br>On delay<br>Off delay<br>ON and OFF delay<br>Impulse (one shot)                   |
| <b>Inverter</b>            | Yes  |
| <b>Switching frequency</b> | SIO Direct: 350 Hz <sup>1)</sup><br>SIO Logic: 300 Hz <sup>2)</sup><br>IOL: 280 Hz <sup>3)</sup> |

<sup>1)</sup> SIO Direct: sensor operation in standard I/O mode without IO-Link communication and without using internal sensor logic or time parameters (set to "direct"/"deactivated").

<sup>2)</sup> SIO Logic: Sensor operation in standard I/O mode without IO-Link communication. Sensor-internal logic or timing parameters plus Automation Functions used.

<sup>3)</sup> IOL: Sensor operation with full IO-Link communication and usage of logic, timing and Automation Function parameters.

|                                  |  |
|----------------------------------|--|
| <b>Response time</b>             | SIO Direct: 1.4 ms <sup>1)</sup><br>SIO Logic: 1.65 ms <sup>2)</sup><br>IOL: 1.75 ms <sup>3)</sup> |
| <b>Repeatability</b>             | SIO Direct: 750 µs <sup>1)</sup><br>SIO Logic: 800 µs <sup>2)</sup><br>IOL: 900 µs <sup>3)</sup>   |
| <b>Switching signal</b>          |  |
| Switching signal Q <sub>L1</sub> | Switching output   |
| Switching signal Q <sub>L2</sub> | Switching output   |

<sup>1)</sup> SIO Direct: sensor operation in standard I/O mode without IO-Link communication and without using internal sensor logic or time parameters (set to "direct"/"deactivated").

<sup>2)</sup> SIO Logic: Sensor operation in standard I/O mode without IO-Link communication. Sensor-internal logic or timing parameters plus Automation Functions used.

<sup>3)</sup> IOL: Sensor operation with full IO-Link communication and usage of logic, timing and Automation Function parameters.

## Classifications

|                       |          |
|-----------------------|----------|
| <b>ECl@ss 5.0</b>     | 27270904 |
| <b>ECl@ss 5.1.4</b>   | 27270904 |
| <b>ECl@ss 6.0</b>     | 27270904 |
| <b>ECl@ss 6.2</b>     | 27270904 |
| <b>ECl@ss 7.0</b>     | 27270904 |
| <b>ECl@ss 8.0</b>     | 27270904 |
| <b>ECl@ss 8.1</b>     | 27270904 |
| <b>ECl@ss 9.0</b>     | 27270904 |
| <b>ECl@ss 10.0</b>    | 27270904 |
| <b>ECl@ss 11.0</b>    | 27270904 |
| <b>ETIM 5.0</b>       | EC002719 |
| <b>ETIM 6.0</b>       | EC002719 |
| <b>ETIM 7.0</b>       | EC002719 |
| <b>ETIM 8.0</b>       | EC002719 |
| <b>UNSPSC 16.0901</b> | 39121528 |

## Connection diagram

Cd-390

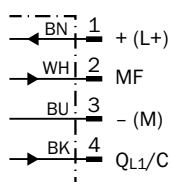

## Characteristic curve

WTS26P-xxxxx1xx

Minimum distance in mm (y) between the set sensing range and background (white, 90%)

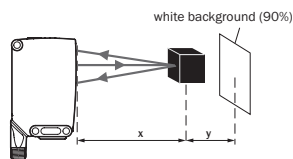
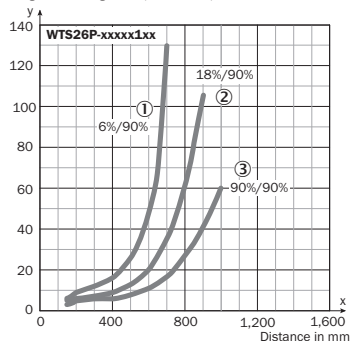

Example:  
 Sensing range on black, 6%,  
 x = 500 mm, y = 25 mm

- ① Sensing range on black, 6% remission
- ② Sensing range on gray, 18 % remission
- ③ Sensing range on white, 90% remission

## Light spot size

WTS26P-xxxxx1xx

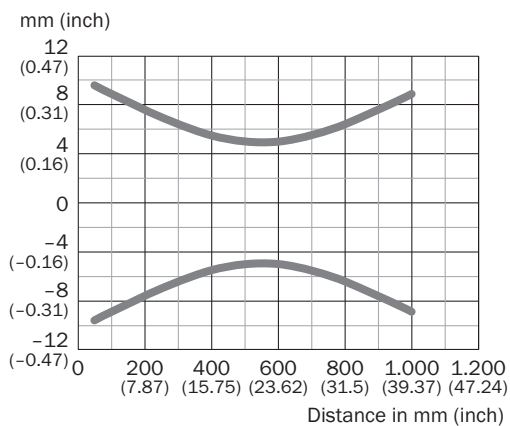

## Sensing range diagram

WTS26P-xxxx1xx

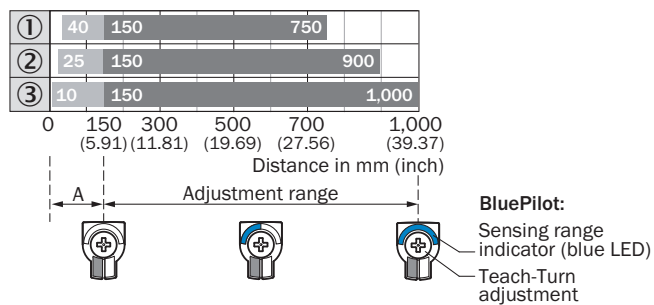

A = Detection distance (depending on object remission)

- ① Sensing range on black, 6% remission
- ② Sensing range on gray, 18 % remission
- ③ Sensing range on white, 90% remission

## Adjustments

Display and adjustment elements

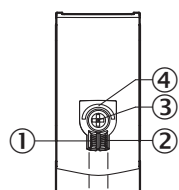

- ① LED indicator green
- ② LED indicator yellow
- ③ Teach-Turn adjustment
- ④ LED indicator blue

### Dimensional drawing (Dimensions in mm (inch))

Display and adjustment elements

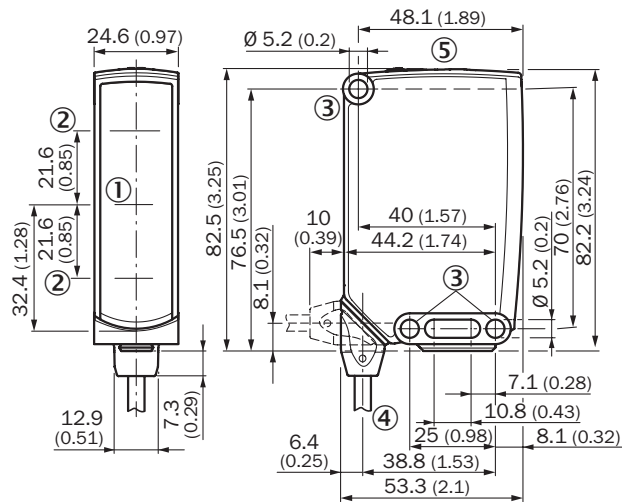

- ① Center of optical axis, sender
- ② Center of optical axis, receiver
- ③ Mounting hole,  $\varnothing$  5.2 mm
- ④ Connection
- ⑤ Display and adjustment elements

### Recommended accessories

Other models and accessories → [www.sick.com/W26](http://www.sick.com/W26)

|                                    | Brief description  | Type               | Part no. |
|------------------------------------|--|--------------------|----------|
| <b>Universal bar clamp systems</b> |  |                    |          |
|                                    | Plate N12 for universal clamp. For mounting PL30A, P250 reflectors, W27 and WTR2 sensors., Zinc plated steel (sheet), Zinc die cast (clamping bracket), Universal clamp (2022726), mounting hardware | BEF-KHS-N12        | 2071950  |
| <b>Plug connectors and cables</b>  |  |                    |          |
|                                    | Head A: female connector, M12, 4-pin, straight, A-coded<br>Head B: Flying leads<br>Cable: Sensor/actuator cable, PVC, unshielded, 5 m  | YF2A14-050VB3XLEAX | 2096235  |
|                                    | Head A: male connector, M12, 4-pin, straight<br>Head B: -<br>Cable: unshielded   | STE-1204-G         | 6009932  |



## Recommended services

Additional services → [www.sick.com/W26](https://www.sick.com/W26)

|   | Type                   | Part no.   |
|---|------------------------|------------|
| Function Block Factory  |                        |            |
| <ul style="list-style-type: none"><li><b>Description:</b> The Function Block Factory supports common programmable logic controllers (PLCs) from various manufacturers, such as Siemens, Beckhoff, Rockwell Automation and B&amp;R. More information on the FBF can be found <a _blank"="" href="https://fbf.cloud.sick.com target=">here</a>.</li></ul> | Function Block Factory | On request |

## SICK AT A GLANCE

SICK is one of the leading manufacturers of intelligent sensors and sensor solutions for industrial applications. A unique range of products and services creates the perfect basis for controlling processes securely and efficiently, protecting individuals from accidents and preventing damage to the environment.

We have extensive experience in a wide range of industries and understand their processes and requirements. With intelligent sensors, we can deliver exactly what our customers need. In application centers in Europe, Asia and North America, system solutions are tested and optimized in accordance with customer specifications. All this makes us a reliable supplier and development partner.

Comprehensive services complete our offering: SICK LifeTime Services provide support throughout the machine life cycle and ensure safety and productivity.

For us, that is “Sensor Intelligence.”

## WORLDWIDE PRESENCE:

Contacts and other locations –[www.sick.com](http://www.sick.com)