

## Features:

- Frequency Range: 6 – 22 GHz
- P1dB: 18.5 dBm @Vdd=5V
- P3dB: 19.5 dBm @Vdd=5V
- Gain: 14 dB
- Vdd =3 to 6 V
- Ids = 130 mA
- Input and Output Fully Matched to 50 Ω

## Applications:

- Communication systems
- Microwave instrumentations
- ECM

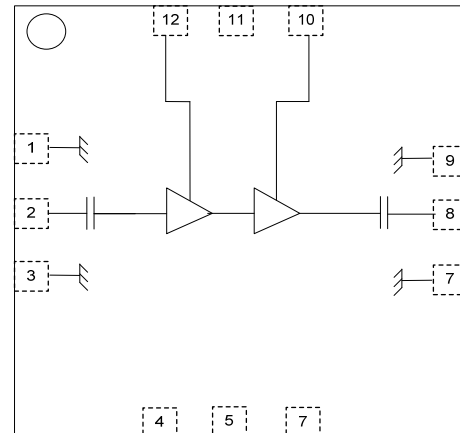

Functional Block Diagram

## Description:

The MMA-062020 is a broadband GaAs MMIC general purpose gain block for 19.5dBm saturated maximum output power and high gain over full 6 to 22GHz frequency range. This amplifier was optimally designed for broadband applications requiring flat gain with excellent input and output port matches.

## Absolute Maximum Ratings: $(T_a = 25\text{ }^\circ\text{C})^*$

SYMBOL	PARAMETERS	UNITS	Min.	Max.
Vd1, Vd2	Drain-Supply Voltage	V		6.5
Id1	Drain Supply Current	mA		70
Id2	Drain Supply Current	mA		84
Pin max	RF Input Power	dBm		20
Toper	Operating Temperature	°C		-40 to +85
Tch	Channel Temperature	°C		+150
Tstg	Storage Temperature	°C		-55 to +165
Tmax	Max. Assembly Temp (60 sec max)	°C		+300

\*Operation of this device above any one of these parameters may cause permanent damage.



# MMA-062020-C3

6-22GHz, 0.1W Gain Block  
Data Sheet

## Electrical Specifications: $V_{ds}=5V, I_{ds}=130mA, T_a=25\text{ }^\circ\text{C}, Z_0=50\text{ ohm}$

Parameter	Units	Typical Data
Frequency Range	GHz	6 - 22
Gain (Typ / Min)	dB	14 / 13.5
Gain Flatness (Typ / Max)	+/-dB	0.8 / 1
Input RL(Typ/Max)	dB	8/6
Output RL(Typ/Max)	dB	10/7
Output P1dB(Typ/Min)	dBm	18.5/18
Output IP3 (1)	dBm	28
Output Psat(Typ/Min)	dBm	19.5/18.5
Operating Current at P1dB (Typ/Max)	mA	130 / 132
Thermal Resistance	$^\circ\text{C} / \text{W}$	65

(1) Output IP3 is measured with two tones at output power of 0 dBm/tone separated by 20 MHz.

### Typical RF Performance: $V_{ds}=5V, I_{ds}=130mA, Z_0=50\text{ ohm}, T_a=25^\circ\text{C}$

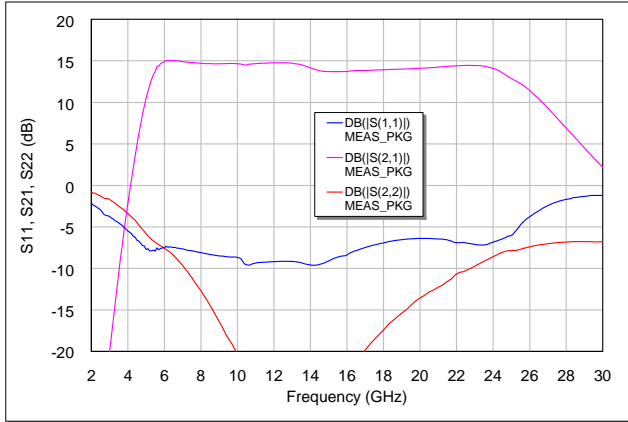

S11[dB], S21[dB], and S22[dB] vs. Frequency

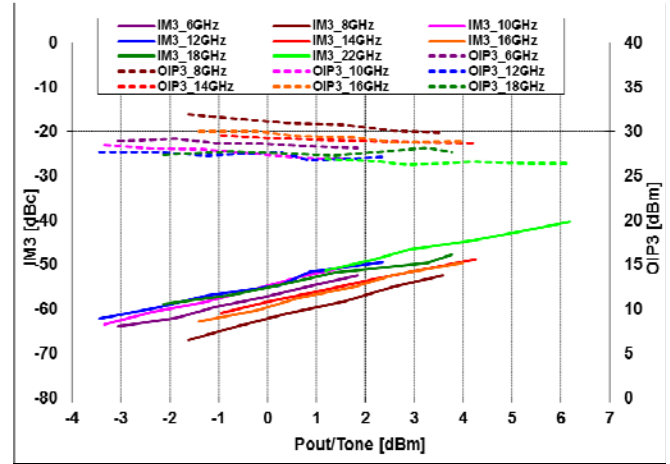

IM3 level [dBc] vs. Output power/tone [dBm]

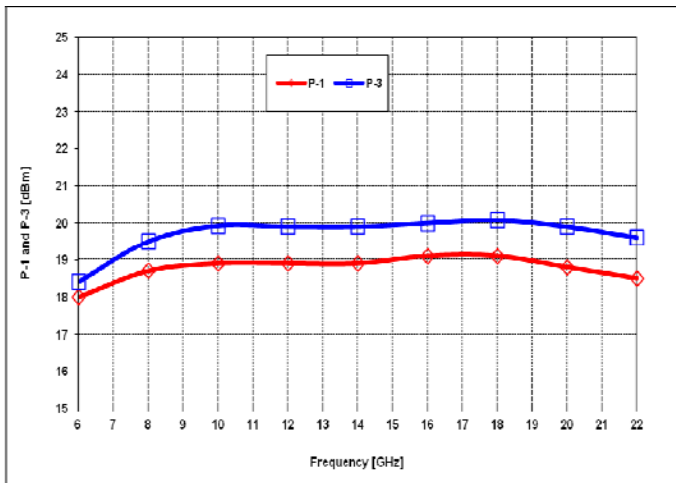

P-1 and Psat vs. Frequency

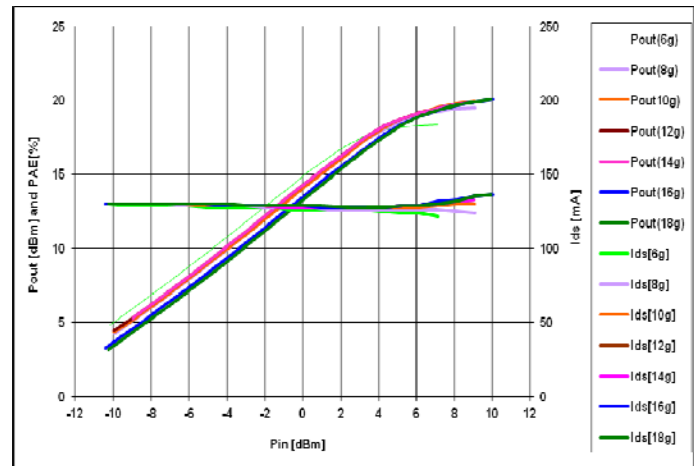

Pout[dBm], Gain[dB], and Ids[mA] vs. Input power [dBm]

## Typical Bias dependent RF Performance:

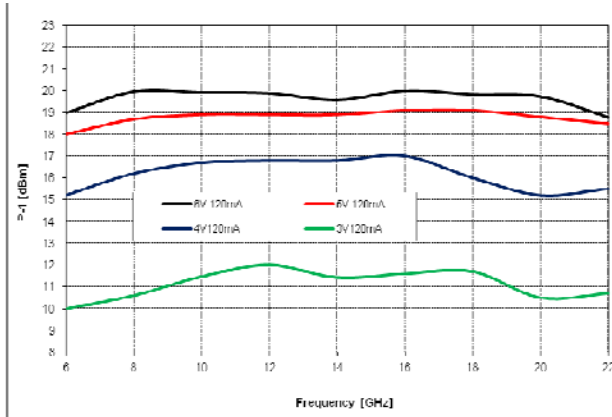

Bias dependent P1 vs. Frequency

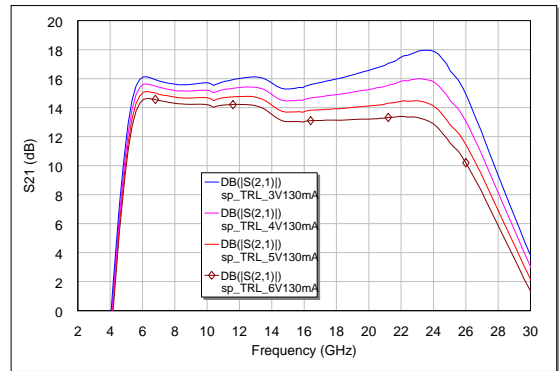

S21(dB) over voltage

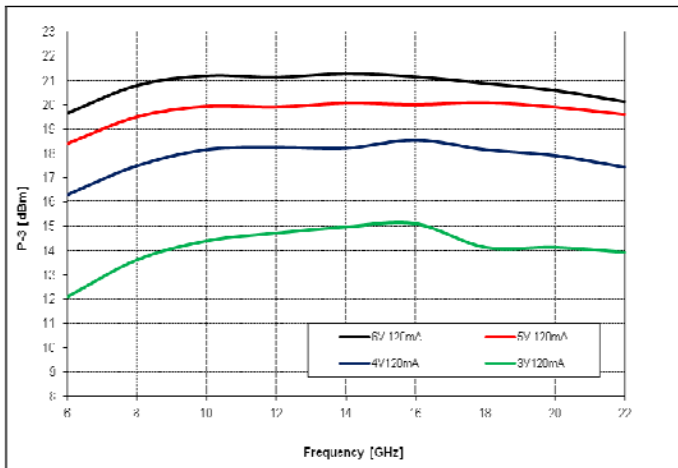

Bias dependent P-3 vs. Frequency

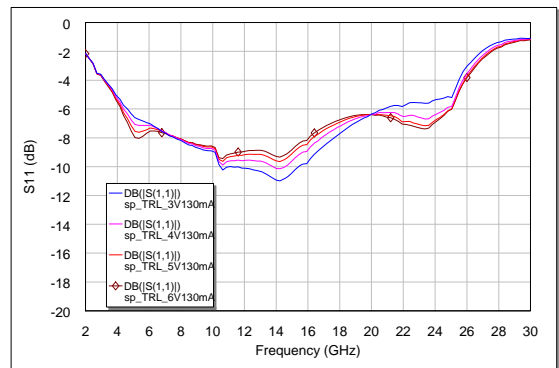

S11(dB) over Voltage

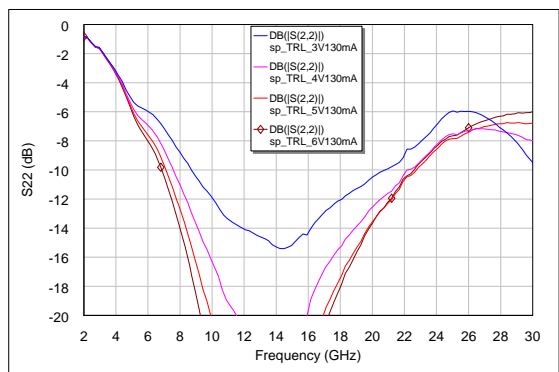

S22(dB) over Voltage

## Typical Over Temperature RF Performance: $V_{ds}=5V, I_{ds}=130mA, Z_0=50\text{ ohm}, T_a=25\text{ }^\circ\text{C}$

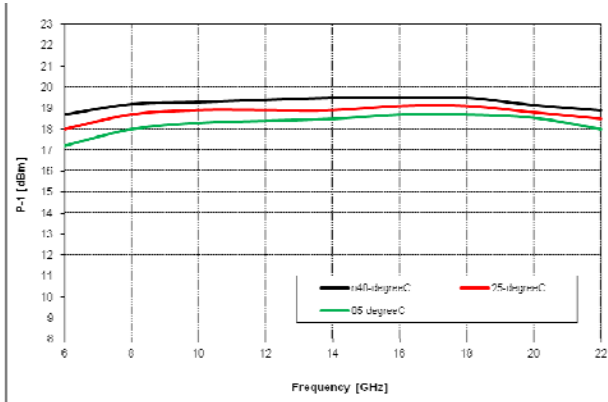

P-1 over temperature

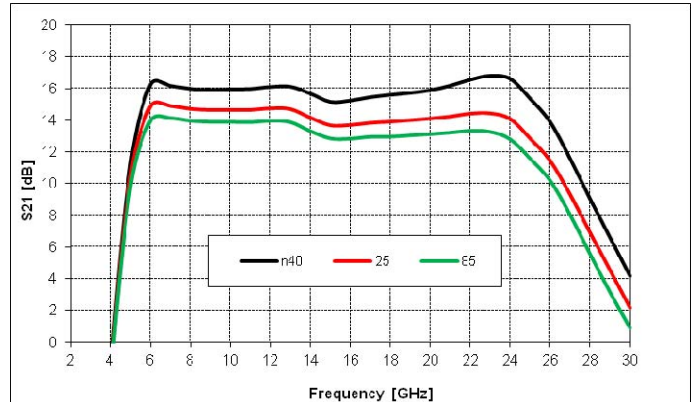

S21(dB) over temperature

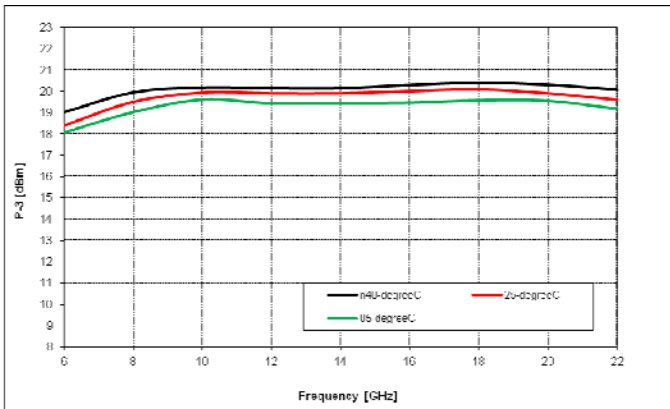

P-3 over temperature

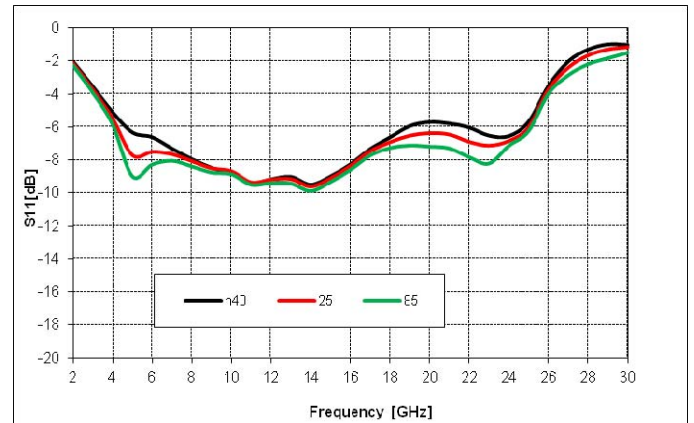

S11(dB) over temperature

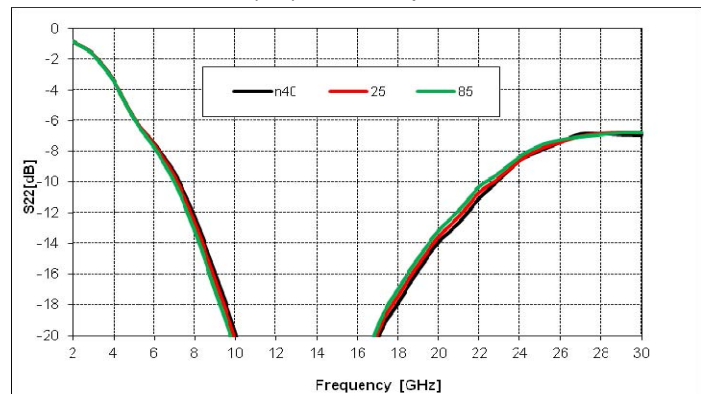

S22(dB) over Voltage



---

## **Applications**

The **MMA-062020-C3** is a GaAs PHEMT amplifier designed for Class-A condition, flat gain performance from 6GHz to 22GHz. It is applicable for cascadable gain stage for EW amplifiers, buffer stages, LO drivers, and transmitter amplifiers used in commercial communication systems. This amplifier is provided as a 3x3mm QFN package, and the packaged amplifier is fully compatible with industry standard high volume surface mount PCB assembly processes.

## **Biassing and Operation**

The **MMA-062020-C3** is normally biased with a single positive supply voltage connected to both Vd1 and Vd2 pins. The recommended drain supply voltages are 3 to 6 volts. RF input and output ports are DC decoupled internally. Typical DC supply connection with bi-passing capacitors for the **MMA-062020-C3** is shown in following pages.

## **Assembly Techniques**

GaAs MMICs are ESD sensitive. ESD preventive measures must be employed in all aspects of storage, handling, and assembly. MMIC ESD precautions, handling considerations, die attach and bonding methods are critical factors in successful GaAs MMIC performance and reliability.

## Package Pin-out:

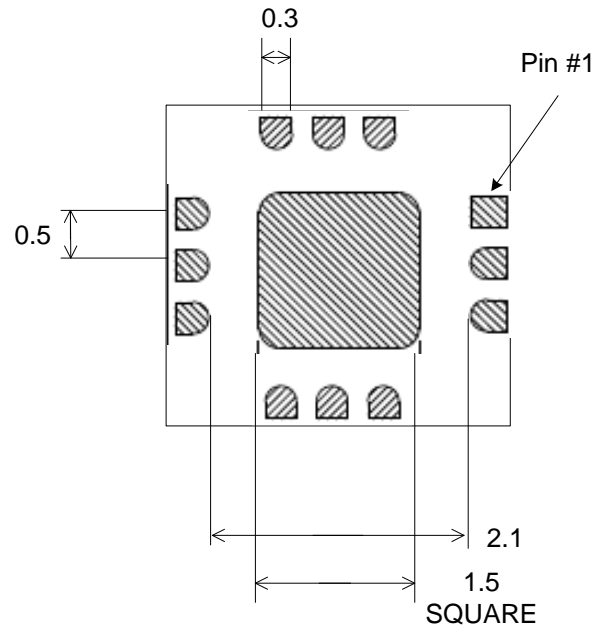
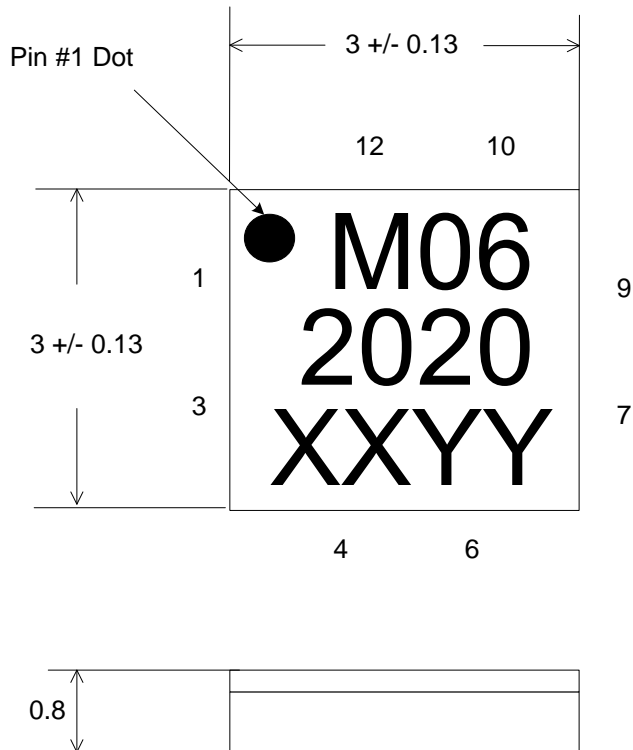

Pin	Description
2	RF Input
8	RF Output
12	Vd1
10	Vd2
1, 3, 7, 9, 13 (center pad)	Ground
4, 5, 6, 11	N/C

## Application Circuit:

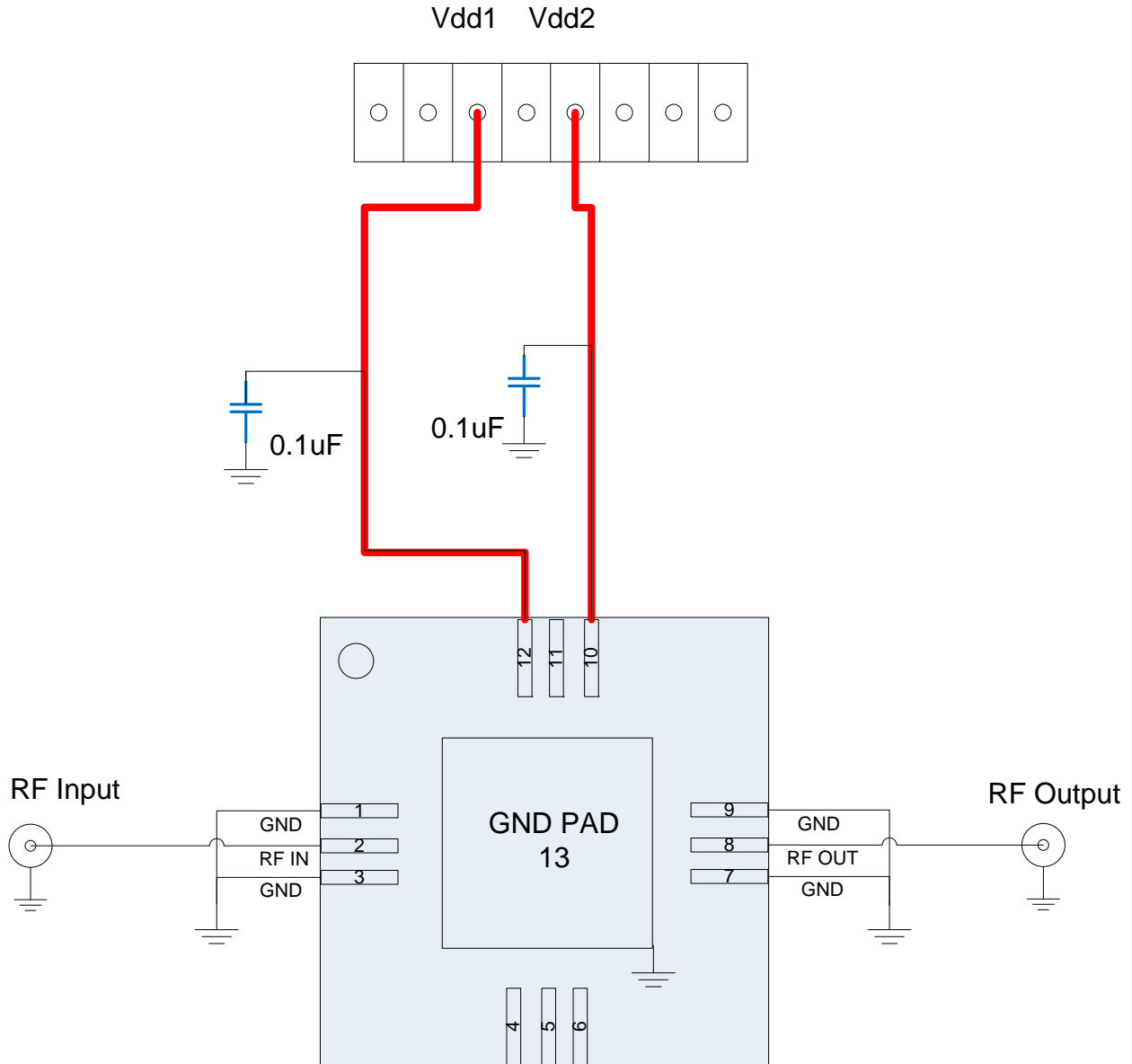



## Recommended Application Board Design:

Board Material is 10mil (Dielectric) thickness Rogers 4350B with 0.5oz copper clads. Board is soldered on a gold plated solid copper block and adequate heat-sinking is required for 0.7W total maximum power dissipation.

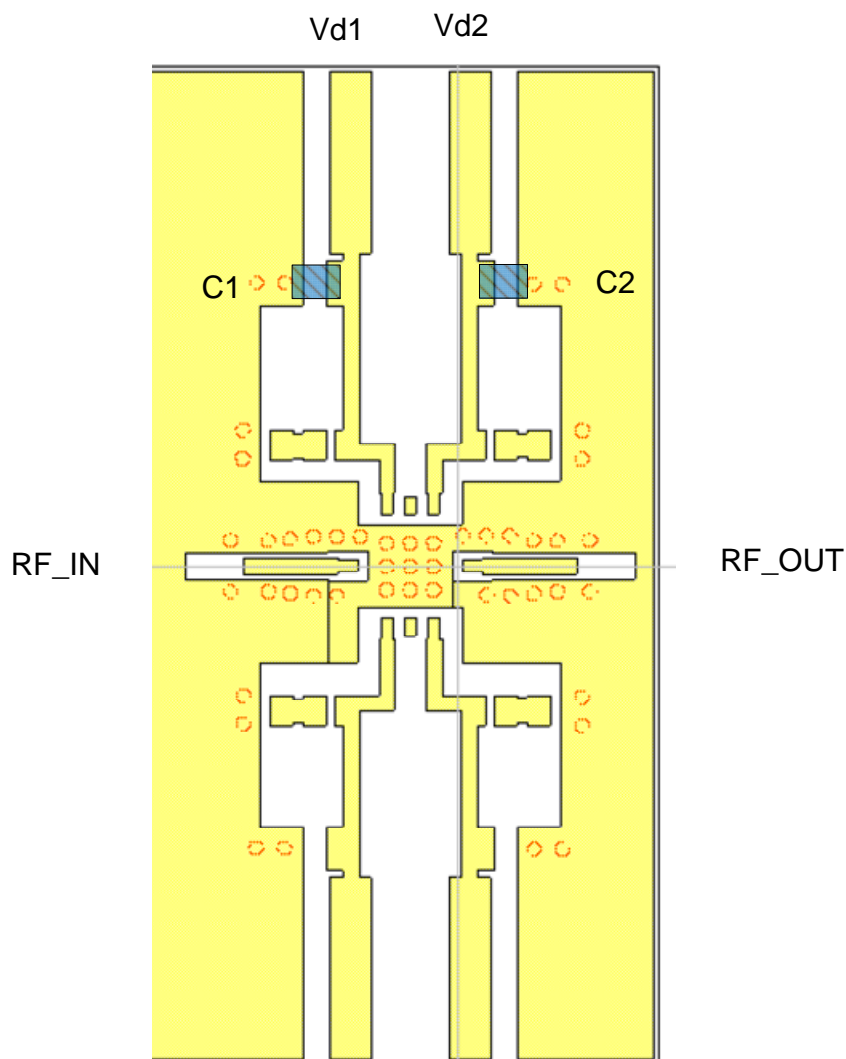

Part	Description
C1, C2	0.1uF capacitor (0603)

## Recommended Application Board Design:

Board Material is 10mil (Dielectric) thickness Rogers 4350B with 0.5oz copper clads. The board material and mounting pattern, as defined in the data sheet, optimizes RF performance and is strongly recommended. An electronic drawing of the land pattern is available upon request from MwT Sales & Application Engineering.

