

Part Number: AM2520P3C03

Features

- Subminiature package.
- Gull wing lead.
- Mechanically and spectrally matched to the infrared emitting LED lamp.
- Package : 1000pcs / reel.
- Moisture sensitivity level : level 3.
- RoHS compliant.

Description

Made with NPN silicon phototransistor chips.

Package Dimensions

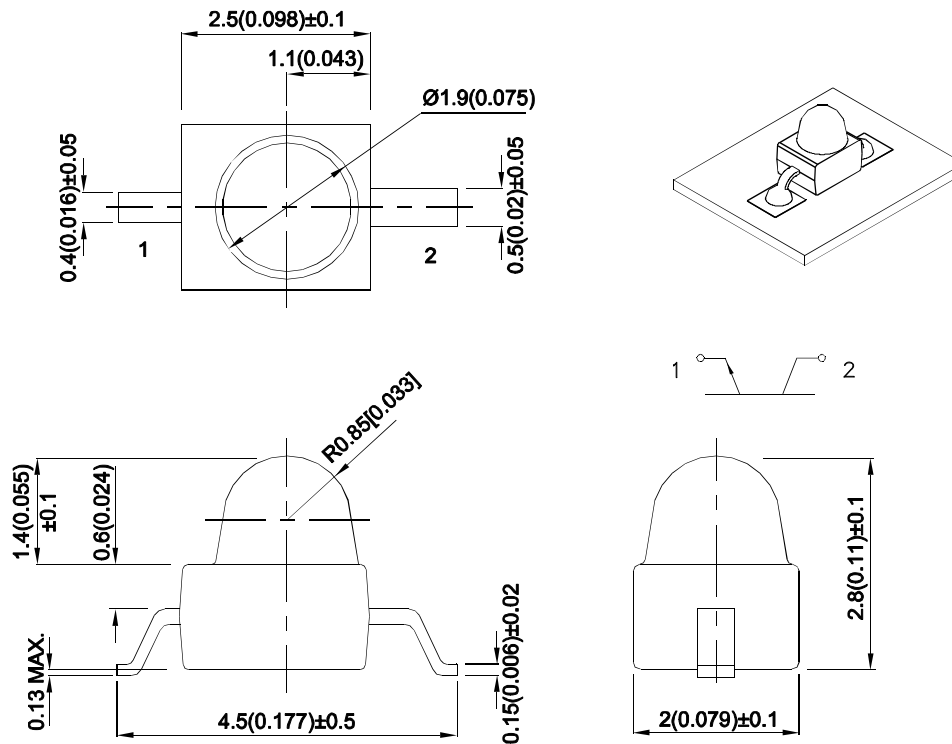

Notes:

1. All dimensions are in millimeters (inches).
2. Tolerance is $\pm 0.25(0.01)$ " unless otherwise noted.
3. Lead spacing is measured where the leads emerge from the package.
4. The specifications, characteristics and technical data described in the datasheet are subject to change without prior notice.
5. The device has a single mounting surface. The device must be mounted according to the specifications.



Electrical / Optical Characteristics at TA=25°C

Symbol	Parameter	Min.	Typ.	Max.	Units	Test Conditions
V _{BR CEO}	Collector-to-Emitter Breakdown Voltage	30			V	I _C =100uA E _e =0mW/cm ²
V _{BR ECO}	Emitter-to-Collector Breakdown Voltage	5			V	I _E =100uA E _e =0mW/cm ²
V _{CE (SAT)}	Collector-to-Emitter Saturation Voltage			0.8	V	I _C =2mA E _e =20mW/cm ²
I _{CEO}	Collector Dark Current			100	nA	V _{CE} =10V E _e =0mW/cm ²
T _R	Rise Time (10% to 90%)		15		us	V _{CE} = 5V I _C =1mA R _L =1000Ω
T _F	Fall Time (90% to 10%)		15		us	
I _(ON)	On State Collector Current	0.8	1.5		mA	V _{CE} = 5V E _e =1mW/cm ² λ=940nm
λ _{0.1}	Range of spectral bandwidth	420		1120	nm	
λ _p	Wavelength of peak sensitivity		940		nm	
2θ _{1/2}	Angle of half sensitivity		20		deg	

Absolute Maximum Ratings at TA=25°C

Parameter	Max.Ratings
Collector-to-Emitter Voltage	30V
Emitter-to-Collector Voltage	5V
Power Dissipation at (or below) 25°C Free Air Temperature	100mW
Operating Temperature	-40°C To +85°C
Storage Temperature	-40°C To +85°C

Note:

1. Relative humidity levels maintained between 40% and 60% in production area are recommended to avoid the build-up of static electricity – Ref JEDEC/JESD625-A and JEDEC/J-STD-033.

Typical Electro-Optical Characteristics Curves

Fig.1 Collector Power Dissipation vs. Ambient Temperature

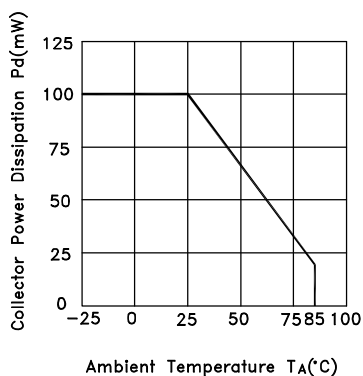

Fig.2 Spectral Sensitivity vs. Wavelength

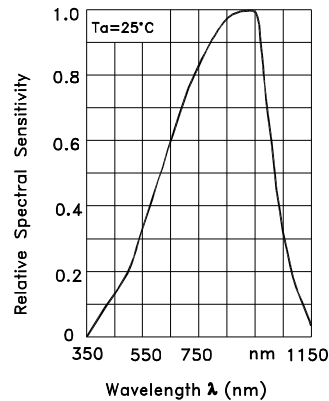

Fig.3 Relative Collector Current vs. Ambient Temperature

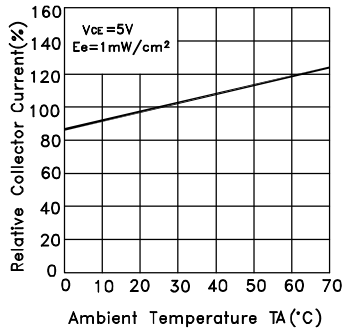

Fig.4 Collector Current
 $I_c = f(E_e), V_{ce} = 5V, T_a = 25^\circ C$

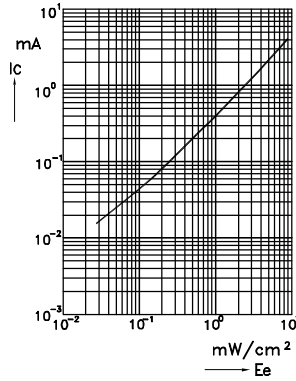

Fig.5 Collector Dark Current vs. Ambient Temperature

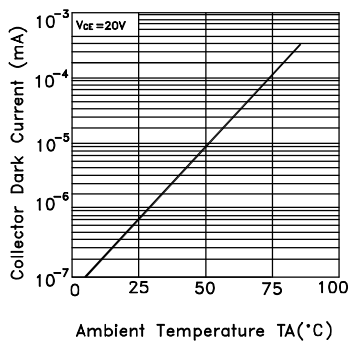

Fig.6 Collector Current vs. Collector-Emitter Voltage

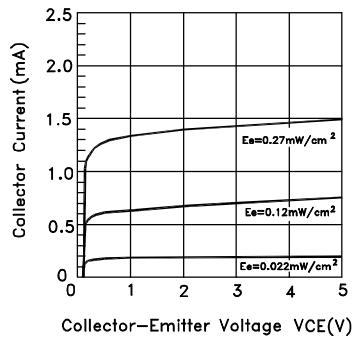
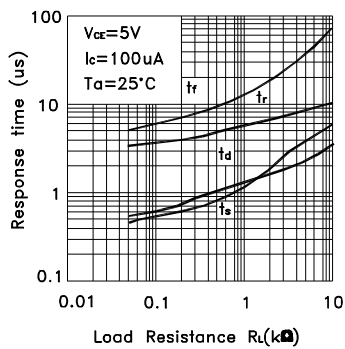
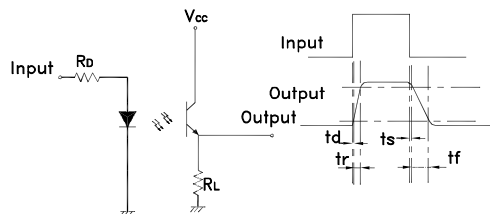

Fig.7 Response Time vs. Load Resistance



Test Circuit for Response Time



PACKING & LABEL SPECIFICATIONS

AM2520P3C03

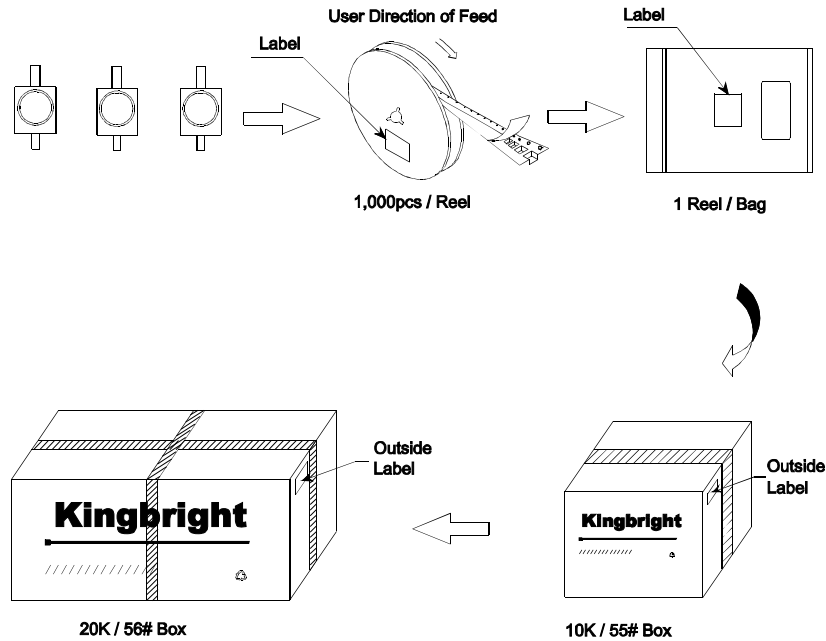

Kingbright			
P/NO: AM2520xxx			
QTY: 1000 pcs	Q.C.		
S/N: XXXX	<table border="1"> <tr> <td style="text-align: center;">Q C</td> </tr> <tr> <td style="text-align: center;">XXXX XXXX PASSED</td> </tr> </table>	Q C	XXXX XXXX PASSED
Q C			
XXXX XXXX PASSED			
CODE: XXX			
LOT NO:			
RoHS Compliant			

Terms and conditions for the usage of this document

1. The information included in this document reflects representative usage scenarios and is intended for technical reference only.
2. The part number, type, and specifications mentioned in this document are subject to future change and improvement without notice. Before production usage customer should refer to the latest datasheet for the updated specifications.
3. When using the products referenced in this document, please make sure the product is being operated within the environmental and electrical limits specified in the datasheet. If customer usage exceeds the specified limits, Kingbright will not be responsible for any subsequent issues.
4. The information in this document applies to typical usage in consumer electronics applications. If customer's application has special reliability requirements or have life-threatening liabilities, such as automotive or medical usage, please consult with Kingbright representative for further assistance.
5. The contents and information of this document may not be reproduced or re-transmitted without permission by Kingbright.
6. All design applications should refer to Kingbright application notes available at <http://www.KingbrightUSA.com/ApplicationNotes>