

S21ME8/S21ME8F

High Repetitive Peak OFF-State Voltage Type Phototriac Couplers

■ Features

- High repetitive peak OFF-state voltage (V_{DRM} : MIN. 800V)
- Low minimum trigger current (I_{FT} : MAX. 3mA)
- Internal insulation distance : 0.5mm or more
- Long creepage distance type
(Creepage distance : 8mm or more)
- Built-in zero-cross circuit
- High isolation voltage between input and output
(V_{iso} : 5 000V_{rms})
- Recognized by UL file No. E64380
Approved by BSI, No. 6690, No. 7421
Approved by SEMKO, No. 9843099
Approved by DEMKO, No. 308207
*DIN-VDE 0884 approved type is also available as an option
(S21ME8Y/S21ME8FY)
Approved by VDE, No. 77294

■ Applications

- For triggering medium/high power triac

■ Absolute Maximum Ratings (Ta=25°C)

	Parameter	Symbol	Rating	Unit
Input	*1 Forward current	I_F	15	mA
	Reverse voltage	V_R	6	V
Output	*1 RMS ON-state current	I_T	0.1	A _{rms}
	Peak one cycle surge current	I_{surge}	*3 1.2	A
	Repetitive peak OFF-state voltage	V_{DRM}	800	V
Operating temperature		T_{opr}	-30 to +100	°C
Storage temperature		T_{stg}	-55 to +125	°C
*2 Isolation voltage		V_{iso}	5 000	V _{rms}
Soldering temperature		T_{SOL}	*4 260	°C

*1 The derating factors of absolute maximum ratings due to ambient temperature are shown in Fig. 1 to 2.

*2 40 to 60%RH, AC for 1min, f=60Hz.

*3 50Hz, sine wave.

*4 For 10s.

■ Outline Dimensions

(Unit : mm)

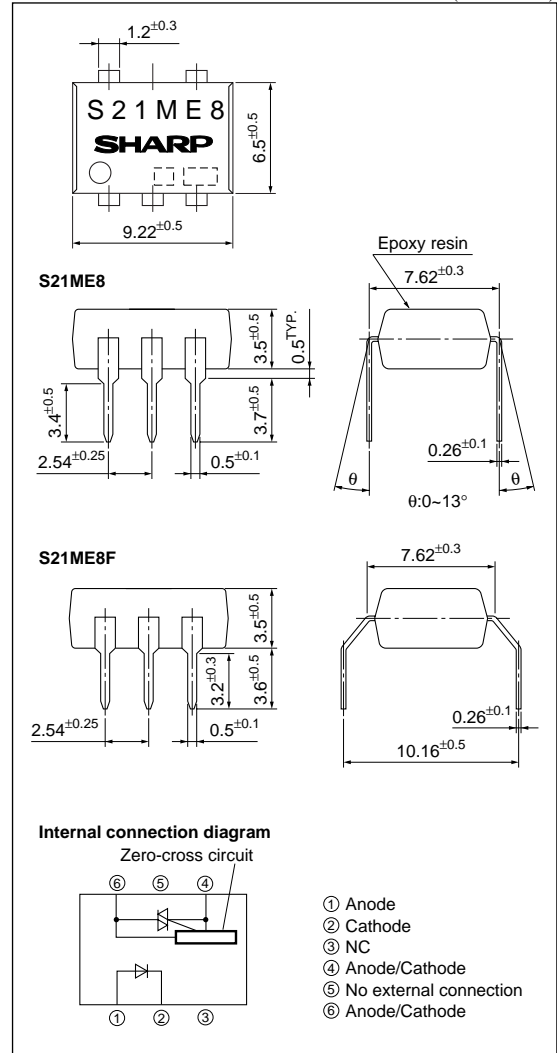

■ Electro-optical Characteristics

(Ta=25°C)

Parameter		Symbol	Conditions	MIN.	TYP.	MAX.	Unit
Input	Forward voltage	V_F	$I_F=6mA$	-	1.2	1.4	V
	Reverse current	I_R	$V_R=3V$	-	-	10^{-5}	A
Output	Repetitive peak OFF-state current	I_{DRM}	$V_{DRM}=\text{Rated}$	-	-	10^{-6}	A
	ON-state voltage	V_T	$I_T=0.1A$	-	1.7	3.0	V
	Holding current	I_H	$V_D=6V$	0.1	-	3.5	mA
	Critical rate of rise of OFF-state voltage	dV/dt	$V_{DRM}=1/\sqrt{2}\text{-Rated}$	500	-	-	V/ μs
Transfer characteristics	Zero-cross voltage	V_{ox}	$I_F=6mA$, Resistance load	-	-	20	V
	Minimum trigger current	I_{FT}	$V_D=6V$, $R_L=100\Omega$	-	-	3.0	mA
	Isolation resistance	R_{iso}	DC=500V, 40 to 60%RH	5×10^{-10}	1×10^{-11}	-	Ω
	Turn-on time	t_{on}	$V_D=6V$, $R_L=100\Omega$, $I_F=6mA$	-	-	50	μs

Fig.1 RMS ON-state Current vs. Ambient Temperature

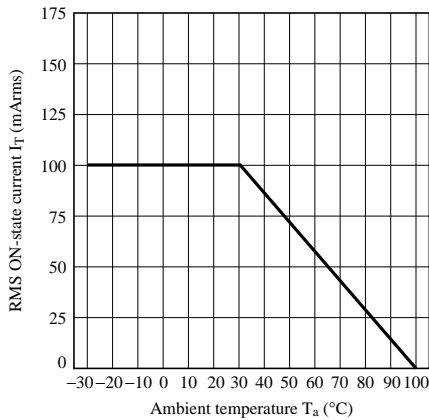

Fig.2 Forward Current vs. Ambient Temperature

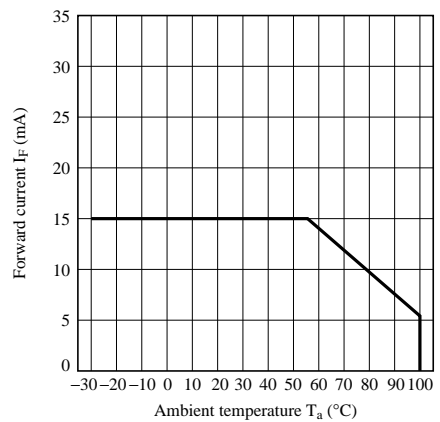

Fig.3 Forward Current vs. Forward Voltage

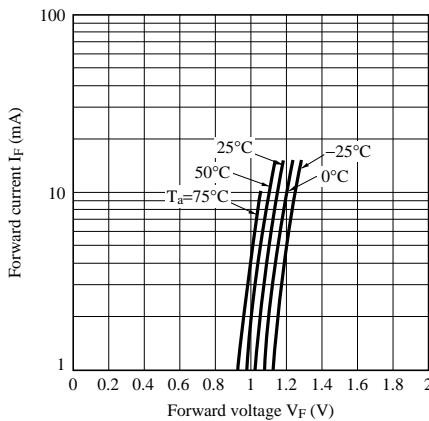

Fig.4 Minimum Trigger Current vs. Ambient Temperature

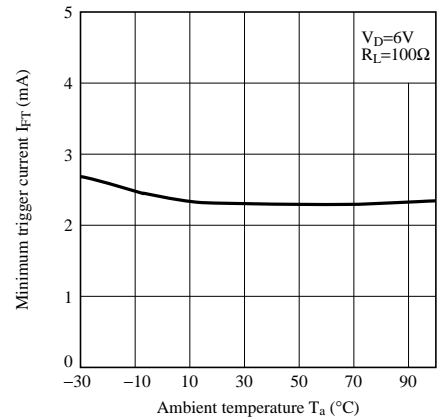

Fig.5 Relative Repetitive Peak OFF-state Voltage vs. Ambient Temperature

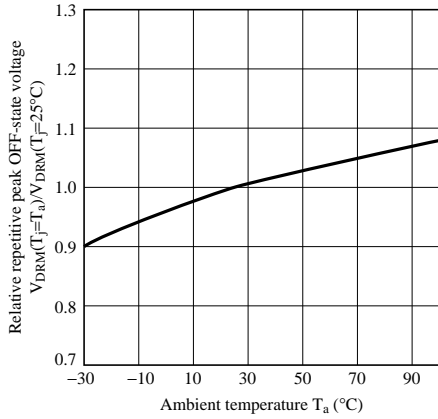

Fig.6 ON-state Voltage vs. Ambient Temperature

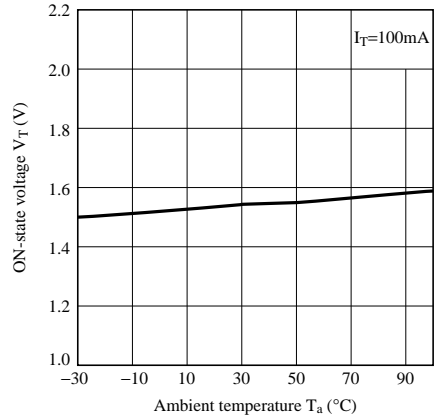

Fig.7 Holding Current vs. Ambient Temperature

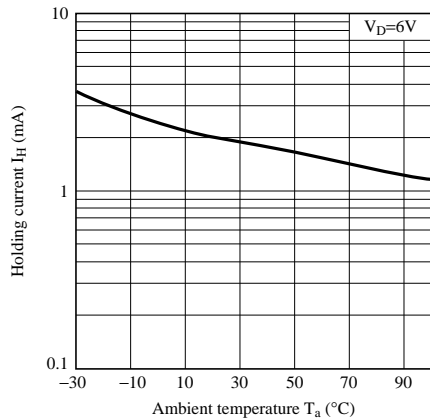

Fig.8 Repetitive Peak OFF-state Current vs. Ambient Temperature

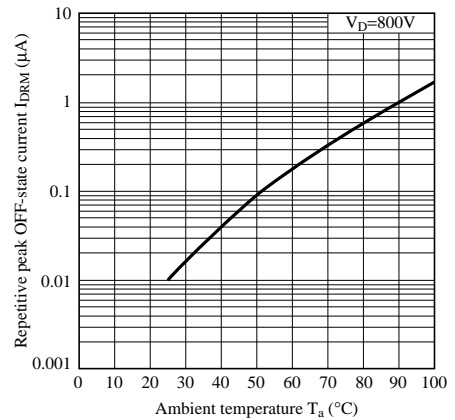

Fig.9 Turn-on Time vs. Forward Current

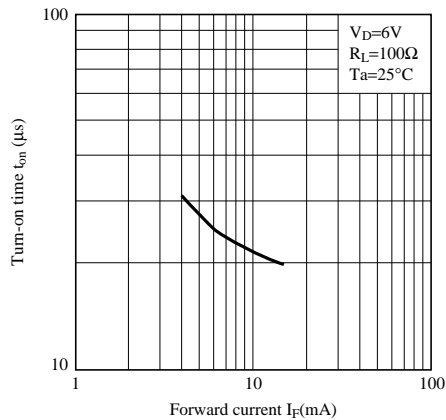

Fig.10 Zero-cross Voltage vs. Ambient Temperature

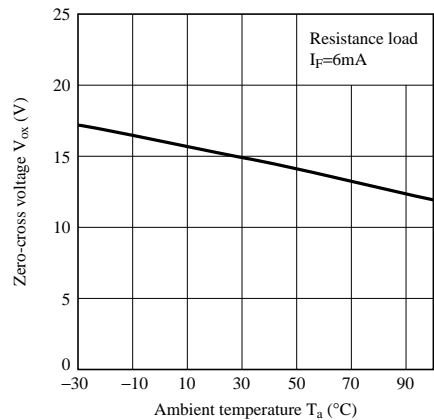

Fig.11 Zero-cross Voltage vs. Forward Current

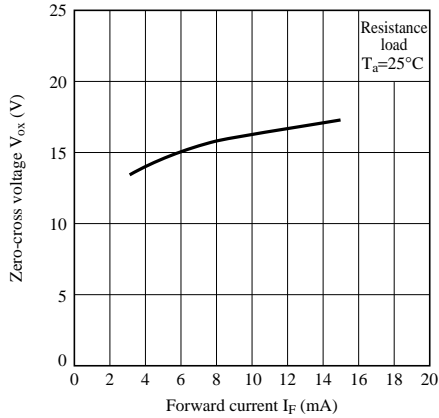

Fig.12 ON-state Current vs. ON-state Voltage

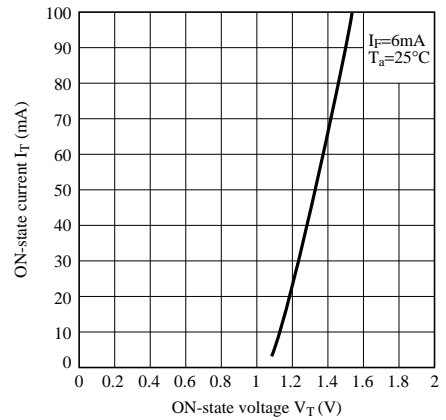
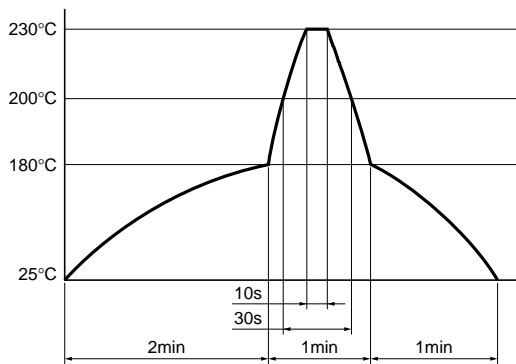

Fig.13 Reflow Soldering

Only one time soldering is recommended within the temperature profile shown below.



NOTICE

- The circuit application examples in this publication are provided to explain representative applications of SHARP devices and are not intended to guarantee any circuit design or license any intellectual property rights. SHARP takes no responsibility for any problems related to any intellectual property right of a third party resulting from the use of SHARP's devices.
- Contact SHARP in order to obtain the latest device specification sheets before using any SHARP device. SHARP reserves the right to make changes in the specifications, characteristics, data, materials, structure, and other contents described herein at any time without notice in order to improve design or reliability. Manufacturing locations are also subject to change without notice.
- Observe the following points when using any devices in this publication. SHARP takes no responsibility for damage caused by improper use of the devices which does not meet the conditions and absolute maximum ratings to be used specified in the relevant specification sheet nor meet the following conditions:
 - (i) The devices in this publication are designed for use in general electronic equipment designs such as:
 - Personal computers
 - Office automation equipment
 - Telecommunication equipment [terminal]
 - Test and measurement equipment
 - Industrial control
 - Audio visual equipment
 - Consumer electronics
 - (ii) Measures such as fail-safe function and redundant design should be taken to ensure reliability and safety when SHARP devices are used for or in connection with equipment that requires higher reliability such as:
 - Transportation control and safety equipment (i.e., aircraft, trains, automobiles, etc.)
 - Traffic signals
 - Gas leakage sensor breakers
 - Alarm equipment
 - Various safety devices, etc.
 - (iii) SHARP devices shall not be used for or in connection with equipment that requires an extremely high level of reliability and safety such as:
 - Space applications
 - Telecommunication equipment [trunk lines]
 - Nuclear power control equipment
 - Medical and other life support equipment (e.g., scuba).
- Contact a SHARP representative in advance when intending to use SHARP devices for any "specific" applications other than those recommended by SHARP or when it is unclear which category mentioned above controls the intended use.
- If the SHARP devices listed in this publication fall within the scope of strategic products described in the Foreign Exchange and Foreign Trade Control Law of Japan, it is necessary to obtain approval to export such SHARP devices.
- This publication is the proprietary product of SHARP and is copyrighted, with all rights reserved. Under the copyright laws, no part of this publication may be reproduced or transmitted in any form or by any means, electronic or mechanical, for any purpose, in whole or in part, without the express written permission of SHARP. Express written permission is also required before any use of this publication may be made by a third party.
- Contact and consult with a SHARP representative if there are any questions about the contents of this publication.