



上海三木电子有限公司

San Technology (Shanghai) Co., Ltd.

# SPECIFICATION FOR LCD MODULE

Customer P/N:  
Santek P/N: ST0430S1W-RSHLW-F  
DOC. Revision: RS01

Customer Approval:

--

	SIGNATURE	DATE
PREPARED BY	Chris	2012-09-10
CHECKED BY	Natty Lee	2012-Sep-13
APPROVED BY	Shiozaki	2012-09-13

Document Revision History

Revision	Date	Description	Changed by
RS01	2012-09-10	First Issue	

Santek / CONFIDENTIAL

## **TABLE OF CONTENTS**

<b>1. GENERAL DESCRIPTION .....</b>	<b>5</b>
<b>2. FEATURES .....</b>	<b>5</b>
<b>3. MECHANICAL SPECIFICATION .....</b>	<b>5</b>
<b>4. MECHANICAL DIMENSION.....</b>	<b>6</b>
<b>5. MAXIMUM RATINGS .....</b>	<b>7</b>
<b>6. ELECTRICAL CHARACTERISTICS .....</b>	<b>7</b>
<b>7. BACKLIGHT CHARACTERISTIC .....</b>	<b>8</b>
<b>8. MODULE FUNCTION DESCRIPTION .....</b>	<b>9</b>
8.1. PIN Description .....	9
8.2. Timing characteristics .....	11
8.3. Functional Descriptions.....	14
8.4. DC ELECTRICAL CHARACTERISTICS.....	16
<b>9. ELECTRO-OPTICAL CHARACTERISTICS .....</b>	<b>17</b>
<b>10. RELIABILITY.....</b>	<b>19</b>
10.1. MTTF.....	19
10.2. Tests .....	19
10.3. Color Performance .....	19
<b>11. INSPECTION CRITERIA.....</b>	<b>20</b>
11.1. Inspection Conditions .....	20
11.2. Light Method.....	20
11.3. Classification Of Defects .....	21
11.4. Sampling & Acceptable Quality Level.....	21
11.5. Definition Of Inspection Area.....	21
11.6. Inspection Item and Criteria .....	22

---

<b>12. PRECAUTIONS FOR USE.....</b>	<b>26</b>
12.1. Safety .....	26
12.2. Storage Conditions.....	26
12.3. Installing LCD Module.....	26
12.4. Precautions For Operation.....	26
12.5. Handling Precautions.....	27
12.6. Guarantee.....	29

Santek / CONFIDENTIAL

## 1. GENERAL DESCRIPTION

ST0430S1W-RSHLW-F is a Transmissive type color active matrix sun readable liquid crystal display which uses amorphous thin film transistor (TFT) as switching devices. This product is composed of a TFT LCD panel, driver ICs, FPC, Bezel and a backlight unit. The following table described the features of ST0430S1W-RSHLW-F.

## 2. FEATURES

Display Mode	Transmissive Type
	TFT LCD, Normally white
Display Format	RGB Strip type
Color	16.7M color
Interface	RGB data bus, 24 bit parallel data
Viewing Direction	6 O'clock (Gray Scale Inversion)
Backlight type / color	LED / White

## 3. MECHANICAL SPECIFICATION

Item	Specifications	Unit
Display Size	4.3	Inch
Dimensional outline	106.7 (W) × 68.0 (H) × 745 (D) *	mm
Resolution	480 × 3 (R,G,B) × 272	dot
Active area	95.04 (W) × 53.856 (H)	mm
Pixel pitch	0.219 (W) × 0.219 (H)	mm
Polarizer	Anti-Glare	

\* Exclude FPC

# 4. MECHANICAL DIMENSION

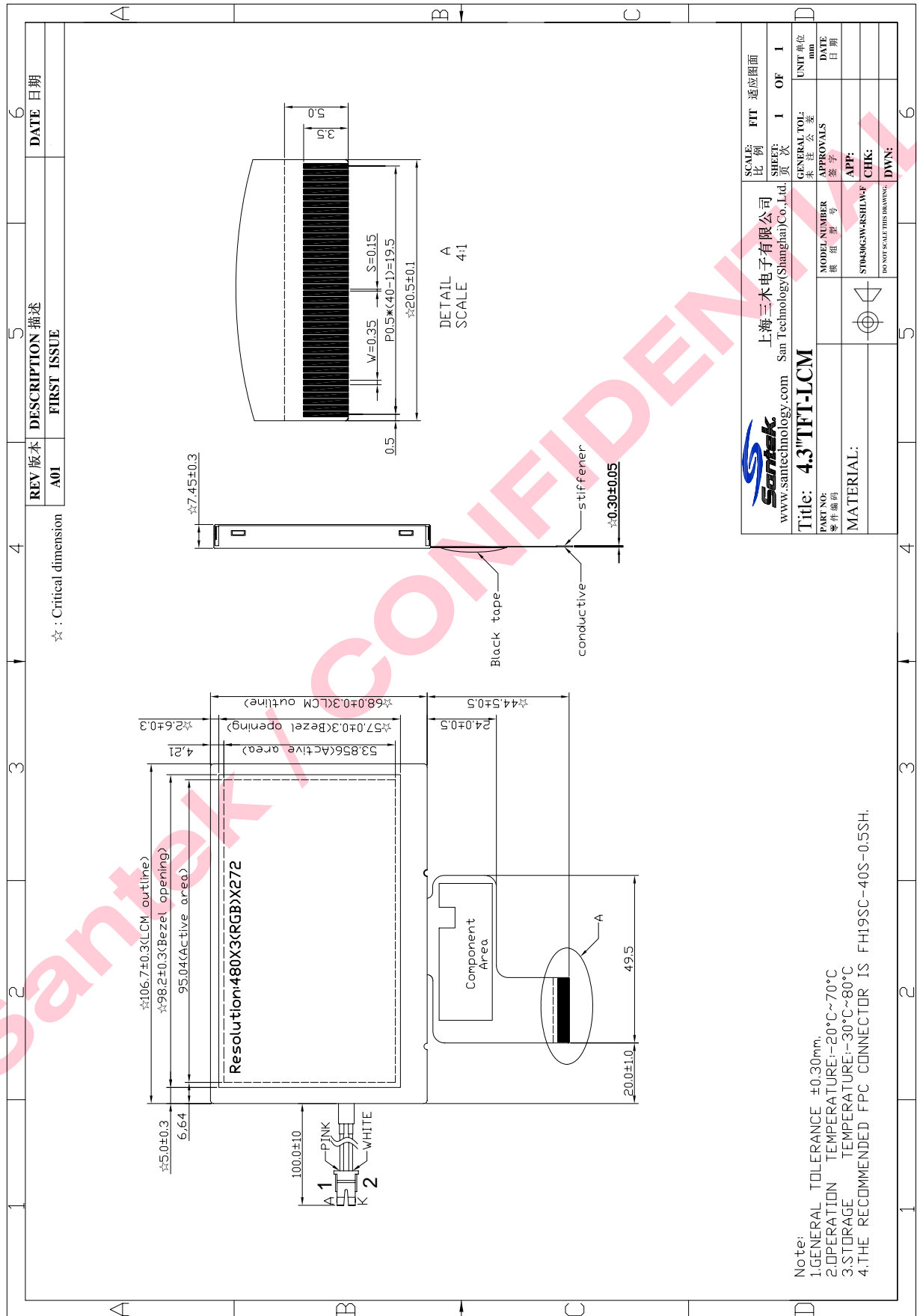

## 5. MAXIMUM RATINGS

If the operating condition exceeds the following absolute maximum ratings, the TFT LCD module may be damaged permanently.

Item	Symbol	Values		Unit	Condition
		Min.	Max.		
Logic supply voltage	VDDIO	-0.5	+5V	V	
Digital Input Voltage	D <sub>in</sub>	0	VDDIO	V	
Storage Temperature	T <sub>ST</sub>	-30	80	°C	
Operating Temperature (Ambient Temperature)	T <sub>OP</sub>	-20	70	°C	
Humidity	-	-	90	%RH	Note1

Note1: T<sub>A</sub> ≤ 40°C Without dewing

## 6. ELECTRICAL CHARACTERISTICS

Item	Symbol	Values			Unit	Remark	
		Min.	Typ.	Max.			
Supply Voltage	VDD	3.0	3.3	3.6	V	Note1	
Input Voltage	H level	V <sub>IH</sub>	0.7*VDDIO	-	VDDIO	V	Note1
	L Level	V <sub>IL</sub>	GND	-	0.3VDDIO	V	Note1
Output t Voltage	H level	V <sub>OH</sub>	VDDIO-0.4	-	-	V	Note1
	L Level	V <sub>OL</sub>	GND	-	GND+0.4	V	Note1
LCD Current Operating mode	-	-	-	21	mA		
LCD Current Standby mode	-	-	-	0.2	mA		
LCD power consumption Operation mode	Pop	-	-	69.3	mW	VDD=3.3V , 25°C	
LCD power consumption Stand by mode	Pstb	-	-	0.66	mW	VDD=3.3V , 25°C	
LCM brightness	B <sub>LCM</sub>	(1200)	(1400)	-	Cd/m <sup>2</sup>	Note 2	

Note1: These supply & Input & Output Voltage base on IC data Sheet.

Note2: a. Test Instrument: BM-7 (Distance =350mm; Field = 1°)

b. Driving conditions: Constant current I<sub>AK</sub> =165 mA

c. Measure position: The center of AA

## 7. Backlight Characteristic

Item	Symbol	Values			Unit	Remark
		Min.	Typ.	Max.		
Power Consumption	$P_{LED}$	-	2.03	-	W	
LED Current	$I_{AK}$	-	165	310	mA	
LED Voltage	$V_{AK}$	8	12.3	16	V	$I_{AK}=165mA, 25^{\circ}C$
LED life time	-	20,000	-	-	Hr	$I_f=55mA, 25^{\circ}C$ Note 2
LED Peak forward Current	$I_p$			120	mA	Note 3
Uniformity	-	70	75	%	Note 4	

Note 1: Santek suggest using constant current driving this backlight unit.

Note 2: The LED chip luminance decrease to be 50% of original

Note 3: For PWM driving each LED only .

Conditions : Pulse width  $T_w \leq 0.1ms$ , Duty ratio  $\leq 1/10$

Note 4:

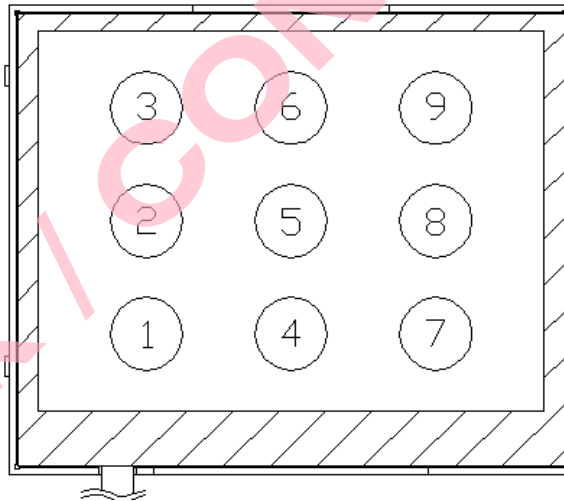

- Test Instrument: BM-7 (Distance = 350mm; Field = 1°)
- Conditions:  $I_{AK} = 165 \text{ mA}$ ,  $V_{AK}$  (Typ.) = 12.3V
- Measure Brightness: 1 ~ 9
- Uniformity = (Min. Brightness / Max. Brightness) \* 100%



## 8. MODULE FUNCTION DESCRIPTION

### 8.1. Pin Description

#### 8.1.1 LCD Pin Description

Pin	Symbol	Description	Remark
1	NC	NC connecting	
2	NC	NC connecting	
3	GND	Power Ground	
4	VDD	Power supply	
5	R0	Red data (LSB)	
6	R1	Red data	
7	R2	Red data	
8	R3	Red data	
9	R4	Red data	
10	R5	Red data	
11	R6	Red data	
12	R7	Red data (MSB)	
13	G0	Green data (LSB)	
14	G1	Green data	
15	G2	Green data	
16	G3	Green data	
17	G4	Green data	
18	G5	Green data	
19	G6	Green data	
20	G7	Green data (MSB)	
21	B0	Blue data (LSB)	
22	B1	Blue data	
23	B2	Blue data	
24	B3	Blue data	
25	B4	Blue data	
26	B5	Blue data	
27	B6	Blue data	
28	B7	Blue data (MSB)	
29	GND	Power ground	

Pin	Symbol	Description	Remark
30	PCLK	Pixel clock	
31	DISP	Display on/off	
32	HSYNC	Horizontal sync signal	
33	VSYNC	Vertical sync signal	
34	DE	Data enable	
35	NC	NC	
36	GND	Power ground	
37	NC	NC	
38	NC	NC	
39	NC	NC	
40	NC	NC	

### 8.1.2. Backlight Pin Description

1	A	Pink	
2	K	White	

## 8.2. Timing characteristics

### 8.2.1. Clock and Data Input Timing Diagram

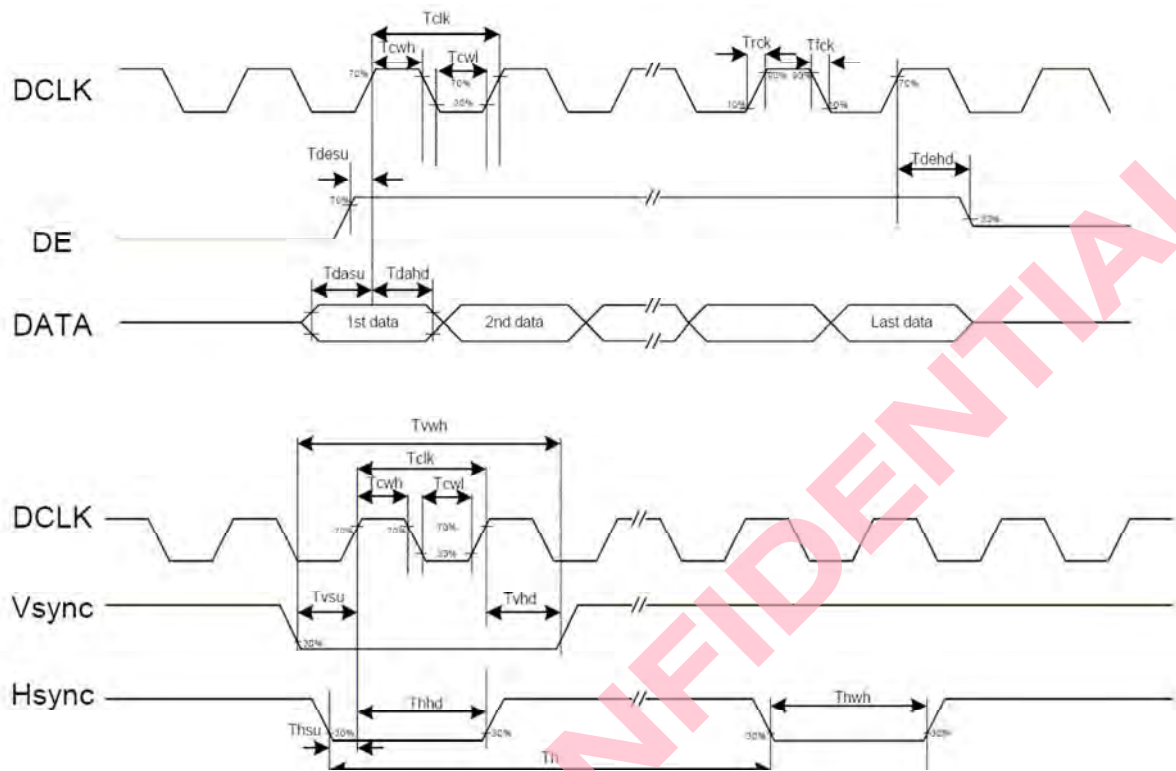

### 8.2.2. Output timing Diagram

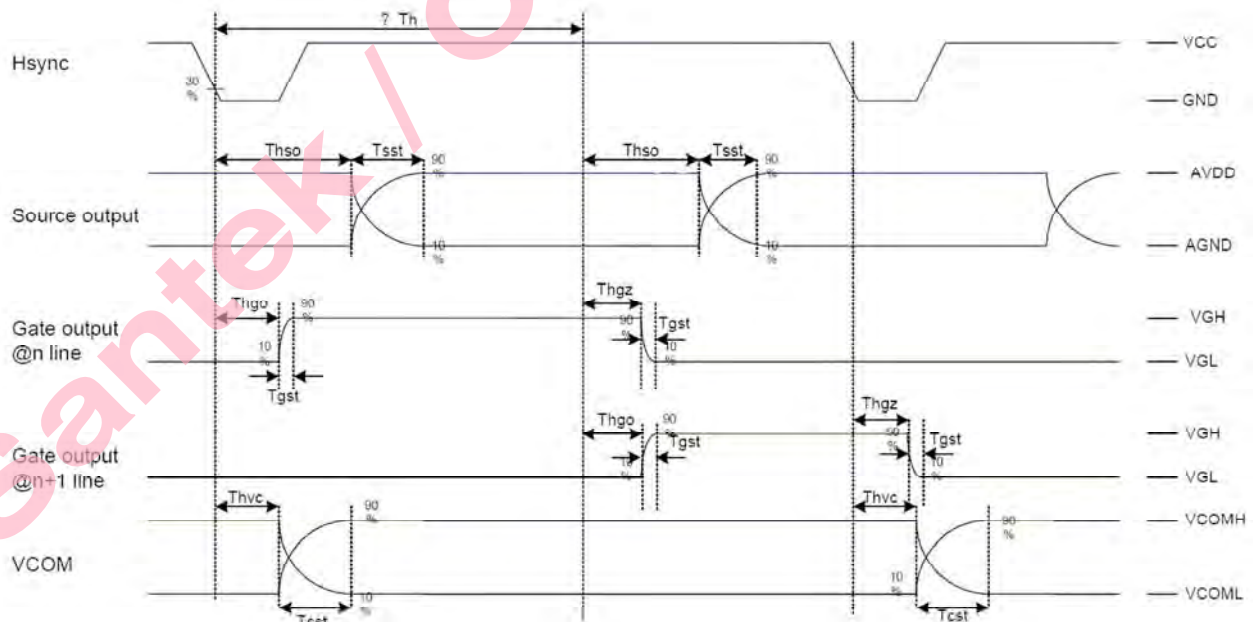

### 8.2.3. AC Electrical Characteristics

AC Electrical Characteristics (VDDIO=VDD=2.7 to 3.6v, GND=0V, TA=-20 to +85 °C)

Parameters	Symbol	Min.	Typ.	Max.	Unit	Conditions
<b>System operation timing</b>						
VDD power source slew time	TPOR	-	-	20	ms	From 0V to 99% VDD
GRB pulse width	tRSTW	10	50	-	us	R=10Kohm, C=1uF
<b>Input Output timing</b>						
DCLK clock time	Tclk	33.3	-	-	ns	DCLK=30MHz
DCLK clock low period	Tcwl	40	-	60	%	
DCLK clock high period	Tcwh	40	-	60	%	
Clock rising time	Trck	9	-	-	ns	
Clock falling time	Tfck	9	-	-	ns	
HSD width	Thwh	1	-	-	DCLK	
HSD period time	Th	55	60	65	us	
HSD setup time	Thsu	12	-	-	ns	
HSD hold time	Thhd	12	-	-	ns	
VSD width	Tvwh	1	-	-	Th	
VSD setup time	Tvsu	12	-	-	ns	
VSD hold time	Tvhd	12	-	-	ns	
Data setup time	Tdasu	12	-	-	ns	
Data hold time	Tdahd	12	-	-	ns	
DE setup time	Tdesu	12	-	-	ns	
DE hold time	Tdehd	12	-	-	ns	
Source output setting time	Tsst	-	-	12	us	10% to 90% CL=60pF, RL=2Kohm
Gate output setting time	Tgst	-	-	1200	ns	10% to 90%, CL=60pF
VCOM output setting time	Tcst	-	-	12	us	10% to 90%, CL=40nF, RL=50ohm
Time from VSD to 1st line data input	Tvs	3	8	31	Th	HV mode By HDL[4:0] setting
<b>3-wire serial communication AC timing</b>						
Serial clock	Tsck	200	-	-	ns	For SCL pin
SCL pulse low period	Tckl	40	-	60	%	
SCL pulse high period	Tckh	40	-	60	%	
Serial data setup time	Tisu	50	-	-	ns	
Serial data hold time	Tihd	50	-	-	ns	
Serial clock high/low	Tssw	50	-	-	ns	
CSB to VSD	Tcv	1	-	-	us	
CSB distinguish time	Tcd	400	-	-	ns	
CSB input setup time	Tcsu	50	-	-	ns	
CSB input hold time	Tchd	50	-	-	ns	

### 8.2.4. Data Input format

Vertical input timing

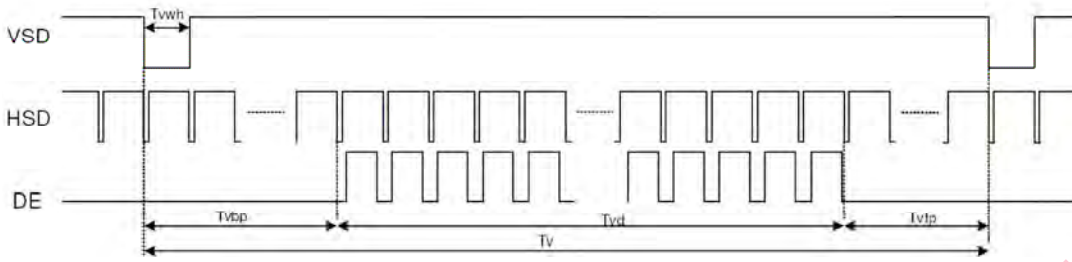

Parallel RGB Mode Data format

(HV Mode)

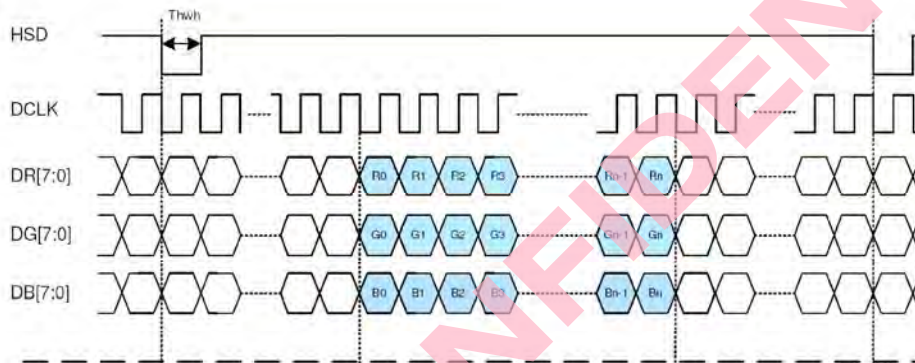

(DE Mode)

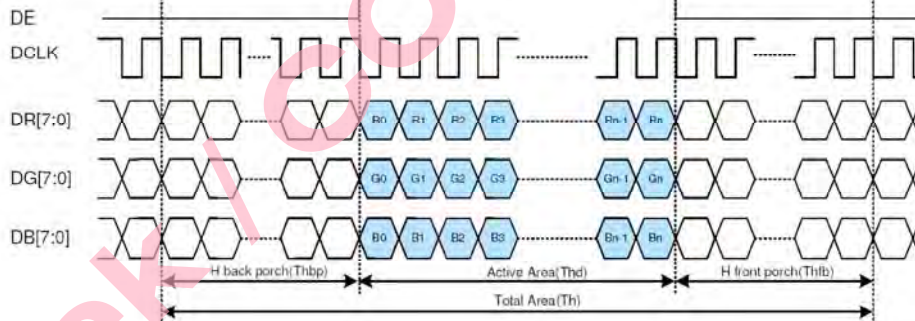

Parallel RGB input timing table

Parameter	Symbol	Value			Unit
		Min.	Typ.	Max.	
DCLK frequency	fclk	5	9	12	MHz
VSD period time	Tv	277	288	400	H
VSD display area	Tvd	272			H
VSD back porch	Tvb	3	8	31	H
VSD front porch	Tvfp	2	8	93	H
HSD period time	Th	520	525	800	DCLK
HSD display area	Thd	480			DCLK
HSD back porch	Thbp	36	40	255	DCLK
HSD front porch	Thfp	4	5	65	DCLK

### 8.3. Functional Descriptions

Global Reset Time ( RGB....pin control )

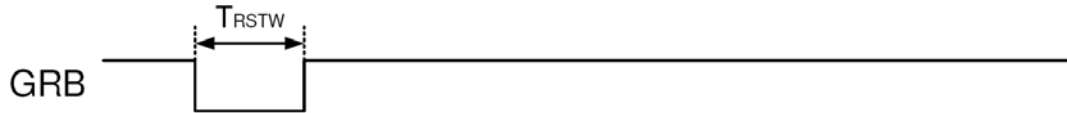

Power on/off sequence:

This IC a high-voltage LCD driver, so it may be damaged by a large current flow if an incorrect power sequence is used. Connecting the drive powers, after the logical power, VCC, is the recommended sequence. When shutting off the power, shut off the drive power and then the logic system or turn off all power simultaneously.

Power on sequence

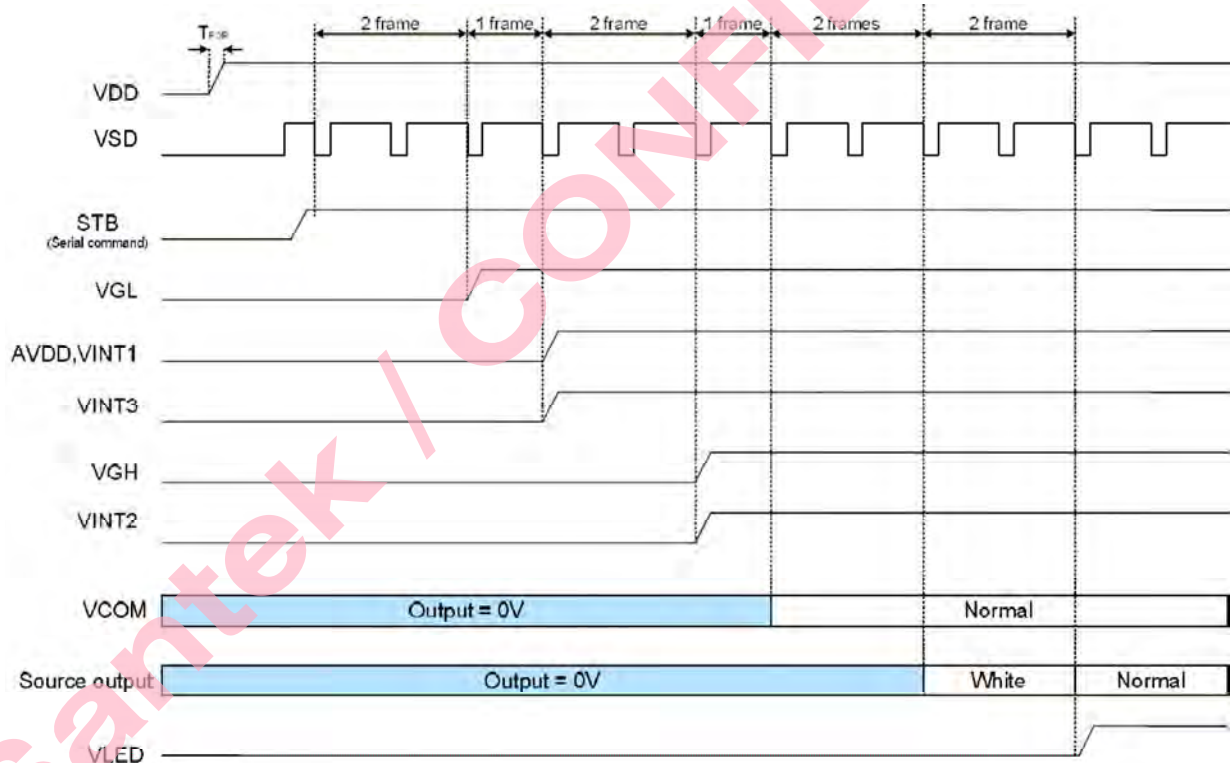

**Power off sequence**

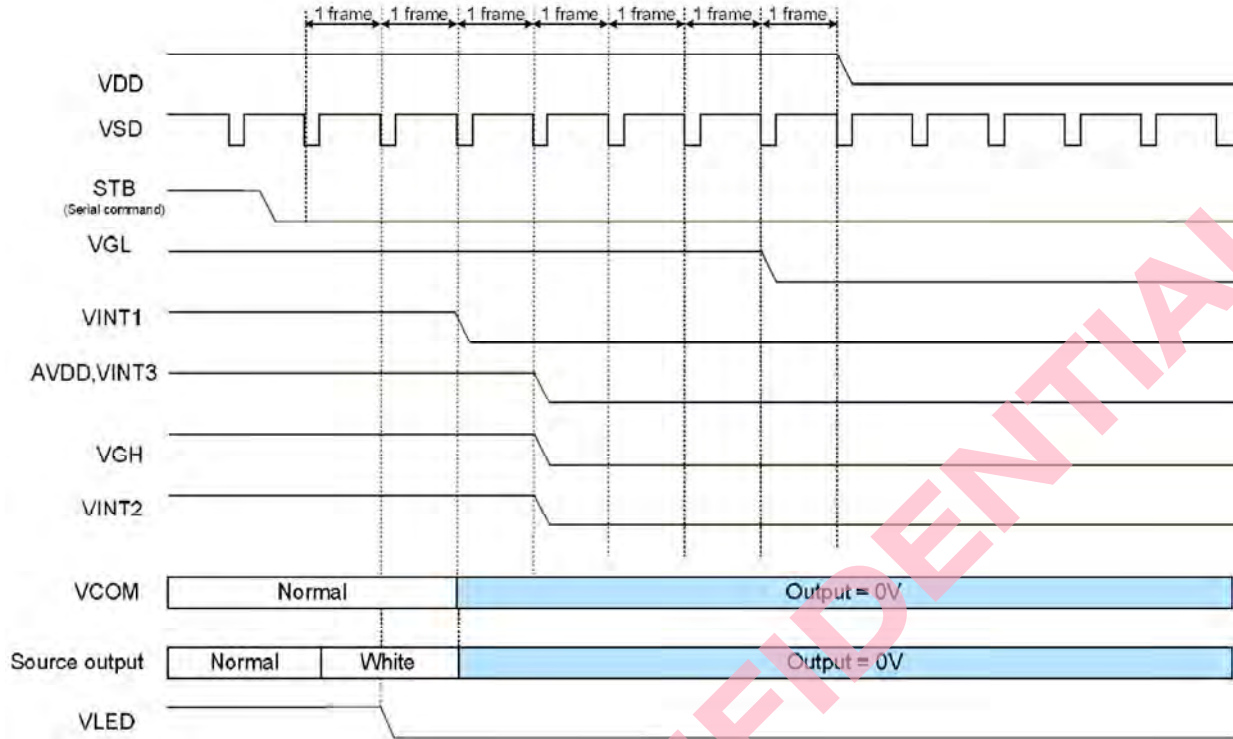

Santek / CONFIDENTIAL

## 8.4. DC ELECTRICAL CHARACTERISTICS

(VDDIO=VDD=2.7 to 3.6V, GND=AGND=PGND=0V, TA= -20 to 85 °C)

Parameters	Symbol	Min.	Typ.	Max.	Unit	Conditions
<b>Digital Block Circuit</b>						
Low Level Input Voltage	Vil	GND	-	0.3xVDDIO	V	Digital input pins
High Level Input Voltage	Vih	0.7xVDDIO	-	VDDIO	V	Digital input pins
Input Leakage Current	Ii	-	-	±1	uA	Digital input pins
Pull-high/low Impedance	Rin	-	200K	-	ohm	Digital control input pins VDDIO=3.3V
High Level Output Voltage	Voh	VDDIO-0.4	-	-	V	Digital output pins Ioh=400uA
Low Level Output Voltage	Vol	GND	-	GND+0.4	V	Digital output pins Iol=400uA
Digital Stand-by Current	I <sub>dst</sub>	-	-	50	uA	Output are High-Z, all pins are default
Digital Operating Current	I <sub>cc</sub>	-	4	-	mA	DCLK=9MHz, Fid=17.28KHz (@ 24bit RGB mode), no load
<b>Analog Block Circuit</b>						
Analog Supply Voltage	AVDD	-	5.2	5.6	V	
GAMMA reference voltage	VDDA	-	5	-	V	
Step-up Circuit 1 Output Voltage	VINT1	5.8	-	-	V	
VCOMH Output Level	VCOMH	2.46	-	5	V	By VCOMH[6:0] setting
VCOML Output Level	VCOML	-3	-	-0.46	V	By VCOML[6:0] setting; VCOML > VINT3
Feed back voltage for PWM	VFB	0.25	0.6	0.8	V	DC-DC operating.
Base drive current for PWM	IDRV	-	20	-	mA	VDD=3.3V
Voltage Deviation of Outputs	V <sub>vd</sub>	-	±20	±35	mV	Vo=0.1V ~ 0.5V & AVDD-0.5 ~ AVDD-0.1
			±15	±20	mV	Vo=0.5V ~ AVDD-0.5V
Dynamic Range of Output	V <sub>dr</sub>	0.1	-	AVDD-0.1	V	S1 to S720
Low-level Output Current of VCOM	IOLC	-	18	-	mA	VCOMH=4V, VCOML=-1V VCOM output=-1V V.S. -0.1V
High-level Output Current of VCOM	IOHC	-	-18	-	mA	VCOMH=4V, VCOML=-1V VCOM output=4V V.S. 3.1V
Source Low-level Output Current	IOLS	-	100	-	uA	S1 to S720; VO=0.1 V.S. 1V
Source High-level Output Current	IOHS	-	-100	-	uA	S1 to S720; VO=4.9 V.S 4.0
Gate Low-level Output Current	IOLG	100	-	-	uA	G1 to G544; VO=VGL V.S. VGL+0.5
Gate High-level Output Current	IOHG	-100	-	-	uA	G1 to G544; VO=VGH V.S. VGH-0.5
Analog Stand-by Current	I <sub>ast</sub>	-	-	100	uA	STB="L", all function are shutdown
Analog Operating Current	I <sub>DD</sub>	-	15	-	mA	DCLK=9MHz, Fid=17.28KHz (@ 24bit RGB mode), No load



## 9. ELECTRO-OPTICAL CHARACTERISTICS

The following items are measured under stable conditions. The optical characteristics should be measured in dark room or equivalent state with the methods shown in Note 1.

Item	Symbol	Condition	Min	Typ	Max	Unit	Remark	
Response time	$T_R+T_F$	$\Theta=0, -20^\circ\text{C}$	-	135	-	ms	Note 2	
		$\Theta=0, 25^\circ\text{C}$	-	25	-			
		$\Theta=0, 70^\circ\text{C}$	-	15	-			
Contrast ratio	CR	At the center point of A.A.	-	450	-	-	Note 3	
Color Chromaticity	White	$W_x$	$\Theta=0$	0.24	0.29	0.34	-	Note 4
		$W_y$		0.25	0.30	0.35		
Viewing Angle	$\Phi_H$	12	$CR \geq 10$	-	50	-	Degree	Note 5
	$\theta_R$	3		-	60	-		
	$\Phi_L$	6		-	65	-		
	$\theta_L$	9		-	60	-		

$T_a=25\pm 2^\circ\text{C}$

Note:

### 1. Test equipment setup

After stabilizing and leaving the panel alone at a given temperature for 30 minutes, the measurement should be executed. Measurement should be executed in a stable, windless, and dark room. Optical specifications are measured by Topcon BM-5A with a viewing angle of  $1^\circ$  at a distance of 50cm and normal direction.

### 2. Definition of response time: $T_R$ and $T_F$

The figure below is the output signal of the photo detector.

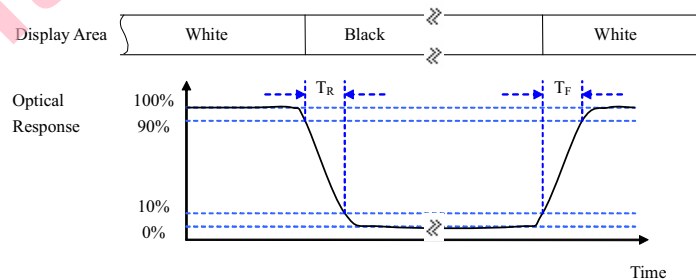

3. Definition of contrast ratio:

$$\text{Contrast ratio (CR)} = \frac{\text{Brightness measured when LCD is at "white state"}}{\text{Brightness measured when LCD is at "black state"}}$$

White  $V_i = V_{i50\%} \pm 1.5V$

Black  $V_i = V_{i50\%} \mp 2.0V$

"±" means that the analog input signal swings in phase with VCOM signal.

"∓" means that the analog input signal swings out of phase with VCOM signal.

$V_{i50\%}$ : The analog input voltage when transmission is 50%.

The 100% transmission is defined as the transmission of LCD panel when all the input terminals of module are electrically opened.

4. Measured at the center area of the panel when all the input terminals of LCD panel are electrically opened.

5. Definition of viewing angle:

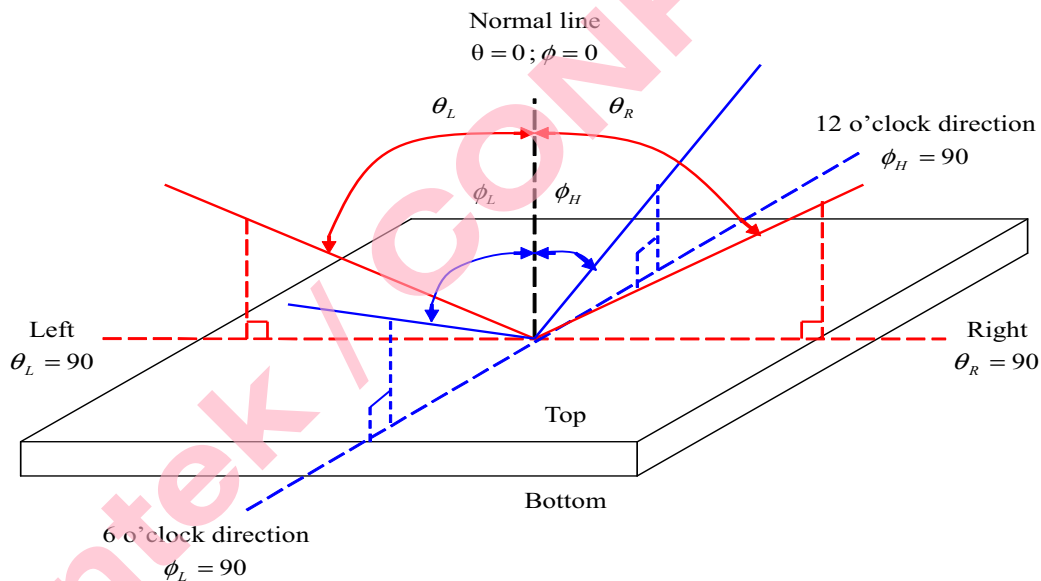

## 10. RELIABILITY

### 10.1. MTTF

The LCD module shall be designed to meet a minimum MTTF value of 50,000 hours with normal condition. (25°C in the room without sunlight; not include lifetime of backlight and Touch Panel).

### 10.2. Tests

NO.	ITEM	CONDITION	CRITERION
1	High Temperature Operating	+70°C 240 hrs	<ul style="list-style-type: none"> <li>◦ No defect of operational function in room temperature are allowable(23±5°C).</li> <li>◦ Leakage current should be below double of initial value.</li> </ul>
2	Low Temperature Operating	-20°C 240 hrs	
3	High Temperature Non-Operating	+80°C 240 hrs	
4	Low Temperature Non-Operating	-30°C 240 hrs	
5	High Temperature/Humidity Non-Operating	50°C ; 90%RH ; 240 hrs	
6	Temperature Shock Operating	-30°C ← → 80°C (30min) (5min) (30min) 10CYCLES	
7	Electro-static Discharge	HBM : ±2kv	

Note 1: Test after 24 hours in room temperature(23±5°C).

Note 2: The sampling above is individually for each reliability testing condition.

Note 3: The color fading of polarizing filter should not care.

Note 4: All of the reliability testing chamber above, is using D.I. water.(Min value:1.0 MΩ-cm)

Note 5: In case of malfunction defect caused by ESD damage, if it would be recovered to normal state after resetting, it would be judged as a good part.

### 10.3. Color Performance

No.	ITEM	Criterion (initial)
1	Luminance	>50%
2	NTSC	>70%
3	Contrast Ratio	>50%

## 11. INSPECTION CRITERIA

### 11.1. Inspection Conditions

#### 11.1.1. Environmental conditions

The environmental conditions for inspection shall be as follows

Room temperature:  $23\pm 5^{\circ}\text{C}$

Humidity:  $50\pm 20\% \text{RH}$

#### 11.1.2. The external visual inspection

With a single  $1000\pm 200$ lux fluorescent lamp as the light source, the inspection was in the distance of 30cm or more from the LCD to the inspector's eyes.

### 11.2. Light Method

#### 11.2.1. Environment lamp under $1000\pm 200$ lux, Viewing direction for inspection over 300 mm

#### 11.2.2. The distance from eye to defect around 300mm, the distance from ND Filter to defect around 25~30mm

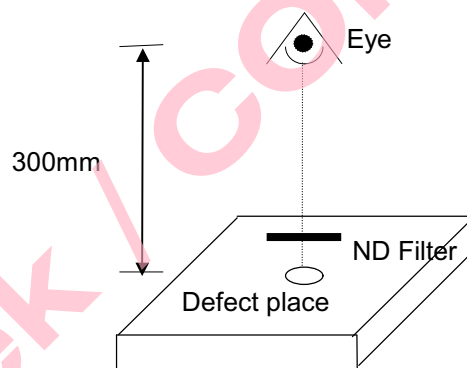

### 11.3. Classification Of Defects

#### 11.3.1. Major defect

A major defect refers to a defect that may substantially degrade usability for product applications.

#### 11.3.2. Minor defect

A minor defect refers to a defect which is not considered to be able substantially degrade the product application or a defect that deviates from existing standards almost unrelated to the effective use of the product or its operation.

Notes: If the LCD/LCM 's cosmetic and display performance do not specify in "inspection criterion", it should be based on these delivered samples.

### 11.4. Sampling & Acceptable Quality Level

Level II, MIL-STD-105E

Inspection Item	Major defect	Minor defect
Cosmetic	1.0%	1.5%
Electrical test	0.4%	0.65%

### 11.5. Definition Of Inspection Area

V.A: Viewing Area

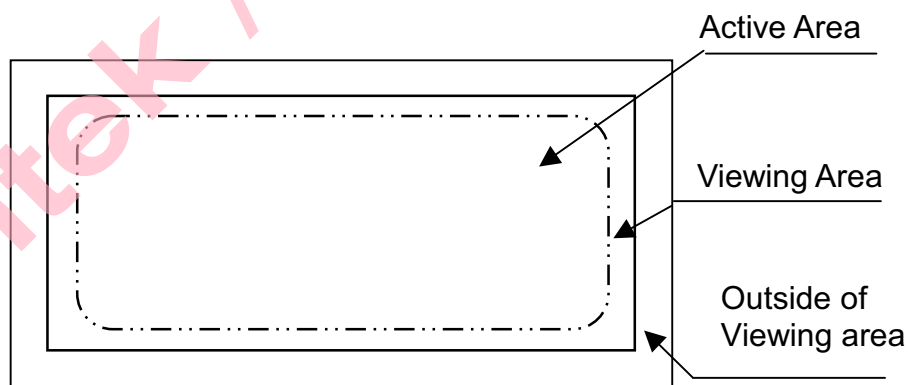

A.A: Active Area



## 11.6. Inspection Item and Criteria

### 11.6.1. Cosmetic criterion

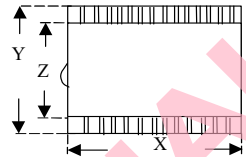
#### (1) Glass defect

No	Defect	Criteria	Remark
1	Dimension (Minor)	By engineering diagram	
2	Cracks (Major)	Extensive crack <b>【Reject】</b>	

#### (2) LCM appearance defect with in A.A

No	Defect	Criteria	Remark	
1	Round type (Minor)	Spec.	Permissible	1. $\phi = (L+W)/2$ , L: Length, W: Width 2. Disregard if out of A.A.
		$\phi < 0.15\text{mm}$	Disregard	
		$0.15\text{mm} \leq \phi \leq 0.50\text{mm}$	3	
		$0.50\text{mm} < \phi$	0	
2	Scratch (Minor)	Spec.	Permissible	1. L: Length, W: Width 2. Disregard if out of A.A.
		$W \leq 0.01\text{mm}$ and $L \leq 10\text{mm}$	Disregard	
		$0.01\text{mm} < W \leq 0.05\text{mm}$ and $L \leq 10\text{mm}$	4	
		$W > 0.05\text{mm}$ or $L > 10\text{mm}$	0	
3	Fiber (Minor)	Spec.	Permissible	1. L: Length, W: Width 2. Disregard if out of A.A.
		$W \leq 1.0\text{mm}$ and $L \leq 1.5\text{mm}$	4	
		$W > 1.0\text{mm}$ or $L > 1.5\text{mm}$	0	
4	Polarizer Bubble (Minor)	Spec.	Permissible	1. $\phi = (L+W)/2$ , L: Length, W: Width 2. Disregard if out of A.A.
		$\phi < 0.25\text{mm}$	Disregard	
		$0.25\text{mm} \leq \phi \leq 0.50\text{mm}$	2	
		$0.50\text{mm} < \phi$	0	

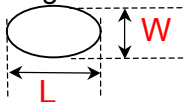
No	Defect	Criteria		Remark
5	Polarizer Dent (Minor)	Spec.	Permissible Q'ty	1. $\phi = (L+W)/2$ , L: Length, W: Width 2. Disregard if out of A.A. 
		$\phi < 0.25\text{mm}$	Disregard	
		$0.25\text{mm} \leq \phi \leq 0.50\text{mm}$	4	
		$0.50\text{mm} < \phi$	0	

(3) FPC

No	Defect	Criteria		Remark
1	Copper peeling (Minor)	Copper peeling	<b>【Reject】</b>	

(4) Black tape

No	Defect	Criteria		Remark
1	Shift (Minor)	IC exposed	<b>【Reject】</b>	
2	No black tape (Minor)	No black tape	<b>【Reject】</b>	

(5) Silicon

No	Defect	Criteria		Remark
1	Amount of silicon (Minor)	ITO exposed	<b>【Reject】</b>	

(6) Bezel

No	Defect	Criteria		Remark
1	Oxidized spot (Minor)	Oxidized spot, rust	<b>【Reject】</b>	
2	Outline deformation (Minor)	By engineering diagram		
3	Greasiness (Minor)	Greasiness	<b>【Reject】</b>	
4	Spots, round Type (Minor)	$H \leq$ By engineering diagram <b>【Disregard】</b>		H=Total height (thickness)
5	Plating (Minor)	Bubble, peeling	<b>【Reject】</b>	

(7) Power cord

No	Defect	Criteria	Remark
1	Power cord (Minor)	Power core loose	

11.6.2. LCM electrical criterion

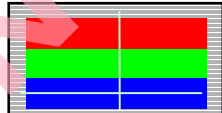
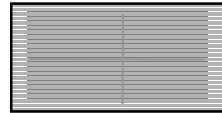
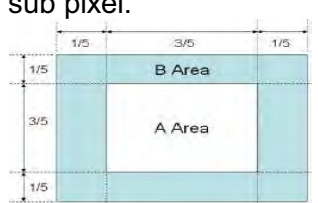
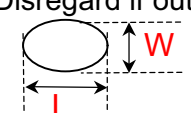
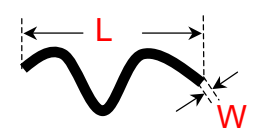
No	Defect	Criteria			Remark	
1	No display (Major)	Not allowed				
2	Missing line (Major)	Not allowed				
3	Darker or lighter line (Major)	Not allowed				
4	Bright / Dark point (Minor)	A Area	B Area	Total	1. 1sub-pixel: 1R or 1G or 1B 2. Point defect area $\geq 1/2$ sub pixel. 	
		Bright point	0	2		2
		Dark dot point	2	3		3
		Bright +Dark point	2	3		4
	Two adjacent dot	0	1	1		
5	Round type (Minor)	Spec.		Permissible Q'ty	1. $\phi = (L+W)/2$ , L: Length, W: Width 2. Disregard if out of A.A. 	
		$\phi < 0.15\text{mm}$		Disregard		
		$0.15\text{mm} \leq \phi \leq 0.50\text{mm}$		3		
		$0.50\text{mm} < \phi$		0		
6	Scratch (Minor)	Spec.		Permissible Q'ty	1. L: Length, W: Width 2. Disregard if out of A.A. 	
		$W \leq 0.01\text{mm}$ and $L \leq 10\text{mm}$		Disregard		
		$0.01\text{mm} < W \leq 0.05\text{mm}$ and $L \leq 10\text{mm}$		4		
		$W > 0.05\text{mm}$ or $L > 10\text{mm}$		0		



No	Defect	Criteria		Remark
7	Fiber (Minor)	Spec.	Permissible Q'ty	1.L: Length, W: Width 2. Disregard if out of A.A. 
		$W \leq 1.0\text{mm}$ and $L \leq 1.5\text{mm}$	4	
		$W > 1.0\text{mm}$ or $L > 1.5\text{mm}$	0	
8	Polarizer Bubble (Minor)	Spec.	Permissible Q'ty	1. $\phi = (L+W)/2$ , L: Length, W: Width 2. Disregard if out of A.A. 
		$\phi < 0.25\text{mm}$	Disregard	
		$0.25\text{mm} \leq \phi \leq 0.50\text{mm}$	2	
		$0.50\text{mm} < \phi$	0	
9	Polarizer Dent (Minor)	Spec.	Permissible Q'ty	1. $\phi = (L+W)/2$ , L: Length, W: Width 2. Disregard if out of A.A. 
		$\phi < 0.25\text{mm}$	Disregard	
		$0.25\text{mm} \leq \phi \leq 0.50\text{mm}$	4	
		$0.50\text{mm} < \phi$	0	
10	Mura (Minor)	By 2% ND filter invisible		

### 11.6.3.Others

1. Issues that are not defined in this document shall be discussed and agreed with both parties. (Customer and supplier)
2. Unless otherwise agreed upon in writing, the criteria shall be applied to both parties. (Customer and supplier)

## 12. PRECAUTIONS FOR USE

### 12.1. Safety

- (1) Do not swallow any liquid crystal, even if there is no proof that liquid crystal is poisonous.
- (2) If the LCD panel breaks, be careful not to get liquid crystal to touch your skin.
- (3) If skin is exposed to liquid crystal, wash the area thoroughly with alcohol or soap.

### 12.2. Storage Conditions

- (1) Store the panel or module in a dark place where the temperature is  $23\pm 5^{\circ}\text{C}$  and the humidity is below  $50\pm 20\% \text{RH}$ .
- (2) Store in anti-static electricity container.
- (3) Store in clean environment, free from dust, active gas, and solvent.
- (4) Do not tear off the vacuum treatment package before assembling.
- (5) Do not place the module near organics solvents or corrosive gases.
- (6) Do not crush, shake, or jolt the panel or module.
- (7) Do not exposed to direct sun light of fluorescent lamps.

### 12.3. Installing LCD Module

Attend to the following items when installing the LCM.

- (1) Cover the surface with a transparent protective plate or touch panel to protect the polarizer and LC cell.
- (2) When assembling the LCM into other equipment, the spacer to the bit between the LCM and the fitting plate should have enough height to avoid causing stress to the module surface, refer to the individual specifications for measurements. The measurement tolerance should be  $\pm 0.1\text{mm}$ .

### 12.4. Precautions For Operation

- (1) Viewing angle varies with the change of liquid crystal driving voltage ( $V_0$ ). Adjust  $V_0$  to show the best contrast.
- (2) Driving the LCD in the voltage above the limit will shorten its lifetime.
- (3) Response time is greatly delayed at temperature below the operating temperature range. However, this does not mean the LCD will be out of the order. It will recover when it returns to the specified temperature range.
- (4) When turning the power on, input each signal after the positive/negative voltage becomes stable.
- (5) Do not apply water or any liquid on product which composed T/P.

---

## 12.5. Handling Precautions

- (1) Avoid static electricity that can damage the CMOS LSI; please wear the wrist strap when handling.
  - (2) The polarizing plate of the display is very fragile. So, please handle it very carefully.
  - (3) Do not give external shock.
  - (4) Do not apply excessive force on the surface; it may cause display abnormal.
  - (5) Do not wipe the polarizing plate with a dry cloth, as it may easily scratch the surface of plate.
  - (6) Do not use ketonics solvent & Aromatic solvent, use with a soft cloth soaked with a cleaning naphtha solvent.
  - (7) Do not operate it above the absolute maximum rating.
  - (8) Do not remove the panel or frame from the module.
- Do not apply water or any liquid on product which composed T/P.

### 12.5.1. Handling precaution for LCM

LCM is easy to be damaged.  
Please note below and be careful for handling!

#### **Correct handling:**



As above picture, please handle with anti-static gloves around LCM edges.

#### **Incorrect handling:**

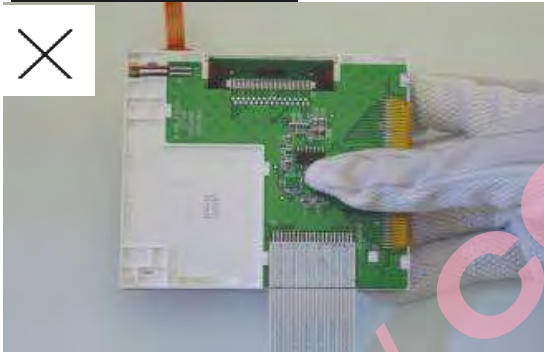

Please don't touch IC directly.

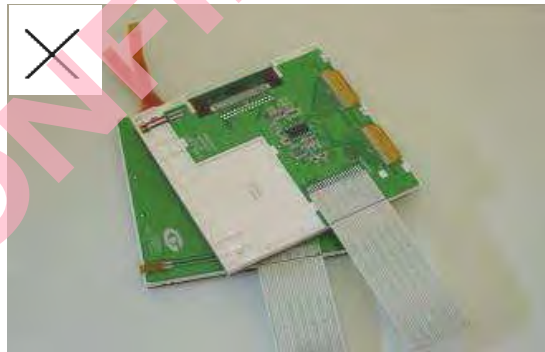

Please don't stack LCM.

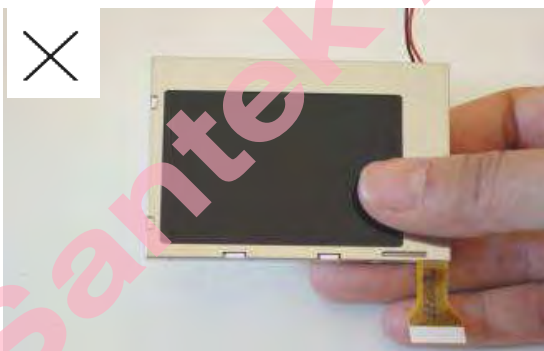

Please don't hold the surface of panel.

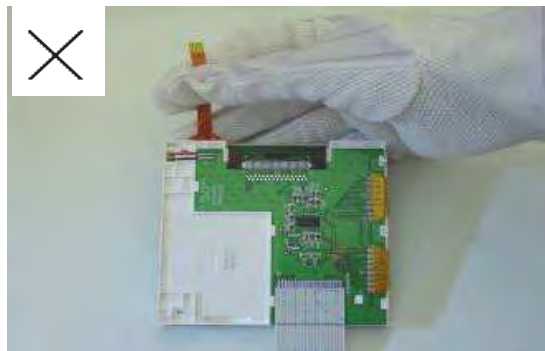

Please don't stretch interface of output, such as FPC cable.

## 12.6. Guarantee

- 12.6.1.** The period is within 12 months since the date of shipping out under normal using and storage conditions.
- 12.6.2.** Any defect not caused by Santek is not guaranteed to the customer. The defect phenomenon should be agreed by both parties.

Santek / CONFIDENTIAL