

DATASHEET

Multi-Channel Superluminescent Diode Source

Integrated Spectral Bench (ISB2)

Multi-SLED Light Source, 6 SLEDs: 1300nm, 1340nm, 1390nm, 1430nm, 1480nm, 1550nm, PM Fiber, High Degree of Polarization, Spectral Coverage: 1265nm-1605nm, FWHM: 340nm, CW: 1435nm, Light Output Power >40mW

Luxmux Part Number: ASM000511



A. PRODUCT DESCRIPTION

The Luxmux broadband multi-superluminescent diode source (Multi-SLED) ASM000511 combines six output beams as a single spectrum product. The system provides individual control of light sources through a digitally controlled interface. Individual SLED performance dashboards are provided for optimum set up calibration as required. The light source is integrated with a high-performance SLED driver and temperature control electronics in a rugged compact package. Power meters can be added for additional monitoring capability.

Luxmux's Spectral Stitching technique of integrating multiple wavelengths into a single broad spectrum is designed for optimum coupling efficiency into a single mode fiber. This brings exceptional flexibility and usability to the sensing marketplace. The Multi-SLED can be spectrally tailored to suit specific application needs and offer excellent back reflection immunity. This provides extremely high stability, making these sources ideal for the applications included below:

B. KEY FEATURES

- Six superluminescent diodes (SLEDs)
- All SLEDs can be run from 0 – 100% of maximum rating
- Fiber-coupled output power: >40mW
- Bandwidth FWHM > 340nm, @10dB > 390nm
- Luxmux's patented technology for spectral stitching provides optimum power and bandwidth
- Multiple communication interfaces: USB, RS-232, Ethernet
- Each SLED comes with a built-in independent monitor photodiode and one common thermoelectric cooler (TEC) for all SLEDs
- Internally optimized for maximum coupling efficiency with PM1550-XP Fiber
- Monolithic integration of a Broadband Dual Stage PMF Isolator (35dB)
- Light output: FC/APC Connector (Optional FC/PC or SMA)
- User friendly GUI and custom API available for test automation

C. APPLICATIONS

- Optical Component Testing
- Telecom Test Equipment
- Medical Optical Coherence Tomography
- Industrial Optical Coherence Tomography
- Metrology
- Biomedical Imaging Systems
- Optical Sensing
- White Light Interferometry & Chromatic Dispersion
- Research and Development

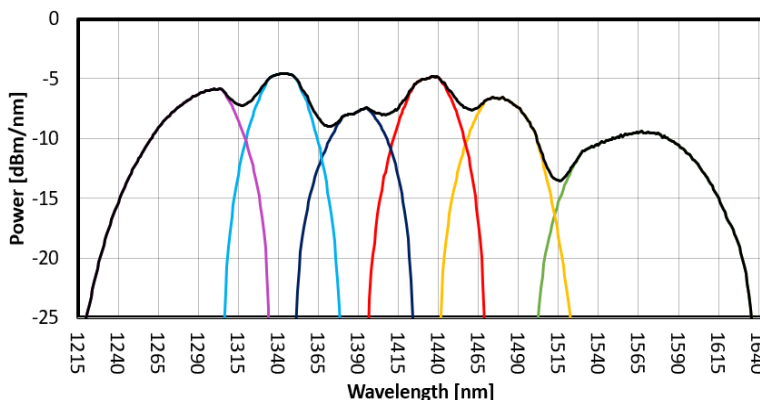

#LTC-ISB2-1300_1340_1390_1430_1480_1550-PM-HP-1265_1605-340-1435-40_DS_2021_08_05

This document is the property of Luxmux, and contains proprietary information. Luxmux reserves the right to make product design or specification changes without notice.



D. ABSOLUTE MAXIMUM RATINGS (see note 1)

| Parameter | Symbol | Condition | Minimum | Maximum | Unit |
|--|-------------------|---------------------------|---------|---------|------|
| DRIVER POWER SUPPLY SPECIFICATIONS | | | | | |
| Input Power Supply Voltage | V _s | CW | 10 | 14 | V |
| Input Power Supply Current | I _s | CW | 5 | - | A |
| TEMPERATURE SPECIFICATIONS | | | | | |
| Case Temperature (see note 2) | T _{Case} | | 0 | 60 | °C |
| Storage Temperature (see note 4) | T _{stg} | No condensation, Unbiased | -40 | 85 | °C |
| Storage Humidity (see note 4) | RH _{stg} | | 5 | 85 | %RH |
| Ambient Operating Temperature (See note 3) | T _{OP} | | 0 | 50 | °C |

Notes:

- Please note that exceeding the Absolute Maximum Ratings above may cause device failure. Luxmux does not bear responsibility for laser power damage that is attributed to electrostatic discharge, excessive current levels, and current spikes (transients). Any attempts to increase the laser drive current above the pre-set limits or recommended specification limits, can damage the device, and nullify the warranty period. It should be emphasized that the current limit set points cannot be exceeded.
- T_{Case} and T_{TEC} are monitored by internal thermistor with external readout.
- For optimum performance of the Integrated Spectral Bench (ISB2), the ISB2 must be operated within the specified temperature ranges. The Multi-SLED® has an internal thermoelectric cooler (TEC) to remove heat from the light source and dissipate it through the ISB2 case. It is required to provide free air circulation around the ISB2 device. It is always recommended to cool down the unit with a fan, and/or to mount the ISB2 on an appropriate heatsink, capable of dissipating up to 15W. The thermal resistance between ISB2 metal case and heatsink can be minimized by applying thermal grease, thermal glue or thermal pad between the contact surfaces. **When the Multi-SLED® is used without a heatsink, maximum ambient operating temperature is 35°C.** The specification lists the operating temperature for the electrical/optical characteristics, which is the temperature of the ISB2 during the time that the specifications were measured. Variation in temperature beyond what is specified can have a significant effect on the optical characteristics, like changes in wavelength or drop in output power.
- Storage temperature and relative humidity should be chosen so the dew point of the humid air around the package is below the storage temperature of the package, to avoid condensation inside the ISB2 enclosure.



Redefining Spectral Boundaries

E. OPTICAL AND ELECTRICAL SPECIFICATIONS (see note 5)

| Parameter | Symbol | Condition | Minimum | Typical | Maximum | Unit |
|---|--------------------|---|---------|---------|---------|------|
| DRIVER POWER SUPPLY SPECIFICATIONS | | | | | | |
| Input Power Supply Voltage | V _s | CW | 10 | 12 | 14 | V |
| Input Power Supply Current | I _s | CW | 5 | - | - | A |
| Input Power Supply Voltage Ripple and Noise | γ | CW | - | - | 200 | mVpp |
| OPTICAL SPECIFICATIONS | | | | | | |
| Center Wavelength (see note 6) | | | | | | |
| SLED 1 – 1550nm | CWL | CW T _{OP} = 25°C T _{TEC} = 21°C IOP | 1540 | 1550 | 1560 | nm |
| SLED 2 – 1480nm | | | 1470 | 1480 | 1490 | |
| SLED 3 – 1430nm | | | 1420 | 1430 | 1440 | |
| SLED 4 – 1390nm | | | 1380 | 1390 | 1400 | |
| SLED 5 – 1340nm | | | 1330 | 1340 | 1350 | |
| SLED 6 – 1300nm | | | 1290 | 1300 | 1310 | |
| SLED 1+2+3+4+5+6 – 1435nm | | | 1425 | 1435 | 1445 | |
| PM Fiber Coupled Power (see note 7) | | | | | | |
| SLED 1 – 1550nm | P | CW T _{OP} = 25°C T _{TEC} = 21°C IOP | 5 | | | mW |
| SLED 2 – 1480nm | | | 6 | | | |
| SLED 3 – 1430nm | | | 8 | - | - | |
| SLED 4 – 1390nm | | | 6 | | | |
| SLED 5 – 1340nm | | | 8 | | | |
| SLED 6 – 1300nm | | | 7 | | | |
| SLED 1+2+3+4+5+6 – 1435nm | | | 40 | | | |
| Bandwidth FWHM (see note 8) | | | | | | |
| SLED 1 – 1550nm | B _{FWHM} | CW T _{OP} = 25°C T _{TEC} = 21°C IOP | | 70 | | nm |
| SLED 2 – 1480nm | | | | 40 | | |
| SLED 3 – 1430nm | | | | 35 | | |
| SLED 4 – 1390nm | | | - | 40 | - | |
| SLED 5 – 1340nm | | | | 35 | | |
| SLED 6 – 1300nm | | | | 50 | | |
| SLED 1+2+3+4+5+6 – 1435nm | | | | 340 | | |
| Bandwidth @ -10dB | | | | | | |
| SLED 1 – 1550nm | B _{@10dB} | CW T _{OP} = 25°C T _{TEC} = 21°C IOP | | 90 | | nm |
| SLED 2 – 1480nm | | | | 65 | | |
| SLED 3 – 1430nm | | | | 60 | | |
| SLED 4 – 1390nm | | | - | 65 | - | |
| SLED 5 – 1340nm | | | | 60 | | |
| SLED 6 – 1300nm | | | | 90 | | |
| SLED 1+2+3+4+5+6 – 1435nm | | | | 390 | | |
| Spectrum Ripple (see note 9) | R | CW T _{OP} = 25°C T _{TEC} = 21°C IOP | < 0.15 | < 0.30 | < 0.45 | dB |

#LTC-ISB2-1300_1340_1390_1430_1480_1550-PM-HP-1265_1605-340-1435-40_DS_2021_08_05

This document is the property of Luxmux, and contains proprietary information. Luxmux reserves the right to make product design or specification changes without notice.

Luxmux Technology Corporation, 1030-2424 4th Street SW, Calgary, Canada, T2S 2T4

sales@luxmux.com, +1 (587) 392-6192, www.luxmux.com



Redefining Spectral Boundaries

| Parameter | Symbol | Condition | Minimum | Typical | Maximum | Unit |
|---|-----------------|---|--|--------------------------|--|-------|
| Spectral Coverage | SC | CW $T_{OP} = 25^{\circ}\text{C}$ $T_{TEC} = 21^{\circ}\text{C } I_{OP}$ | - | 1265 – 1605 | - | nm |
| Polarization Extinction Ratio (see note 10) SLED 1 – 1550nm SLED 2 – 1480nm SLED 3 – 1430nm SLED 4 – 1390nm SLED 5 – 1340nm SLED 6 – 1300nm | PER | CW $T_{OP} = 25^{\circ}\text{C}$ $T_{TEC} = 21^{\circ}\text{C } I_{OP}$ | 19.0 20.1 19.5 17.8 18.0 17.8 | - | - | dB |
| RIN | RIN | CW $T_{OP} = 25^{\circ}\text{C}$ $T_{TEC} = 21^{\circ}\text{C } I_{OP}$ | - | < -130 | - | dB/Hz |
| Power Stability (After 1h warm up) | P_{STAB} | $T_{OP} = 25^{\circ}\text{C} \pm 2.5$ | - | < 0.1 | - | dB |
| Warmup Time | W | CW $T_{OP} = 25^{\circ}\text{C}$ $T_{TEC} = 21^{\circ}\text{C } I_{OP}$ | 15 | 30 | 60 | Min. |
| CONSTANT CURRENT MODE | | | | | | |
| Operating Current SLED 1 – 1550nm SLED 2 – 1480nm SLED 3 – 1430nm SLED 4 – 1390nm SLED 5 – 1340nm SLED 6 – 1300nm | I_{OP} | CW $T_{OP} = 25^{\circ}\text{C}$ $T_{TEC} = 21^{\circ}\text{C } I_{OP}$ | - | - | 500 350 350 400 400 500 | mA |
| Current Setting Resolution | R_{IOP_SET} | | | | 0.1 | mA |
| SLED Current Reading Resolution | R_{IOP_READ} | | | 0.1 | | mA |
| MODULATION MODE | | | | | | |
| Waveform | | | - | Square | - | |
| Modulation Frequency Range | f_{mod} | | 0.016 | - | 1000 | Hz |
| Duty Cycle | D | | 10 | 50 | 90 | % |
| INTERNAL MONITOR DIODE | | | | | | |
| Monitor Diode Current Reading | I_{mon} | | - | - | 500 | uA |
| Monitor Diode Current Reading Resolution | $RES_{I_{mon}}$ | | - | 7.6 | - | nA |
| LIGHT OUTPUT CONNECTOR | | | | | | |
| Type of Fiber Connector | | | - | FC/PC, FC/APC, SMA | - | |

#LTC-ISB2-1300_1340_1390_1430_1480_1550-PM-HP-1265_1605-340-1435-40_DS_2021_08_05

This document is the property of Luxmux, and contains proprietary information. Luxmux reserves the right to make product design or specification changes without notice.

Luxmux Technology Corporation, 1030-2424 4th Street SW, Calgary, Canada, T2S 2T4

sales@luxmux.com, +1 (587) 392-6192, www.luxmux.com



Redefining Spectral Boundaries

| Parameter | Symbol | Condition | Minimum | Typical | Maximum | Unit |
|--|------------------------------|--------------------|----------------------|-------------------------|-----------------------|-------------------------|
| SLED TEC SPECIFICATIONS | | | | | | |
| SLED TEC Temperature Setpoint | T _{SLED_SET} | | 0 | - | 40 | °C |
| SLED TEC Temperature Setpoint Resolution | R _{TSLED_SET} | | - | 0.1 | - | °C |
| SLED TEC Temperature Reading | T _{SLED_READ} | | -40 | - | 100 | °C |
| SLED TEC Temperature Reading Resolution | R _{TSLED_READ} | | - | 0.1 | - | °C |
| TEMPERATURE SPECIFICATIONS | | | | | | |
| Heatsink Temperature Reading Range | T _{HS} | | -40 | - | 100 | °C |
| Heatsink Temperature Reading Resolution | R _{T_{HS}} | | - | 0.1 | - | °C |
| SLED 6 Temperature Reading | R _{T_{HS}6} | | -40 | | 75 | °C |
| POWER METER | | | | | | |
| Spectral Response Range | λ _{PM} | | 900 | - | 1870 | nm |
| Photosensitive Area | A _{PM} | | - | Φ1 | - | mm |
| Power Meter Current Reading | P _{PM} | | 50 | - | - | uA |
| Peak Sensitivity Wavelength | λ _p | | - | 1750 | - | nm |
| Photo Sensitivity | S | λ = λ _p | 0.9 | 1.1 | - | A/W |
| Typical Dark Current | I _D | | | 1 | 10 | nA |
| Detectivity | D* | λ = λ _p | 2 x 10 ¹² | 5.5 x 10 ¹² | - | cm*Hz ^{1/2} /W |
| Noise Equivalent Power | NEP | λ = λ _p | - | 1.5 x 10 ⁻¹⁴ | 4 x 10 ⁻¹⁴ | W/Hz ^{1/2} |
| POWER METER TEC SPECIFICATIONS | | | | | | |
| Power Meter TEC Temperature Setpoint | T _{PM_SET} | | -20 | - | 40 | °C |
| Power Meter TEC Temperature Setpoint Resolution | R _{TPM_SET} | | - | 0.1 | - | °C |
| Power Meter TEC Temperature Reading | T _{PM_READ} | | -40 | - | 85 | °C |
| Power Meter TEC Temperature Reading Resolution | R _{TPM_READ} | | - | 0.1 | - | °C |
| Notes: | | | | | | |
| 5. There may be differences in typical values of output power, power stability, wavelength and bandwidth, due to coupling efficiency. These values are references and there is no guarantee that each particular ISB2 module will have EXACTLY the typical values shown on the previous chart. | | | | | | |
| 6. Center Wavelength is defined as the center point of the 3dB bandwidth of each individual SLED. | | | | | | |
| 7. The ISB2 – Integrated Spectral Bench uses a Dual Stage Isolator for back reflection protection. Isolators are used to protect a source from back reflections or signals that may occur after the isolator. Back reflections can damage a laser source or cause it to amplitude modulate, or frequency shift. In high-power applications, back reflections can cause instabilities and power spikes. Luxmux does not bear responsibility for laser power damage that is attributed to hot spots in the beam. | | | | | | |

#LTC-ISB2-1300_1340_1390_1430_1480_1550-PM-HP-1265_1605-340-1435-40_DS_2021_08_05

This document is the property of Luxmux, and contains proprietary information. Luxmux reserves the right to make product design or specification changes without notice.

8. BeST-SLED® FWHM is defined as the bandwidth from the lowest spectral dip, when all the SLEDs are on.
9. Resolution of 0.1nm. Figure of merit does not include dips between SLEDs.
10. Polarization Extinction Ratio is defined as the ratio of optical powers of perpendicular polarizations, expressed in decibels (dB).

F. PLOTS - Test performed at $T_{OP}=25^{\circ}C$ and $T_{TEC}=21^{\circ}C$

FIG. 1: ISB2 SPECTRUM

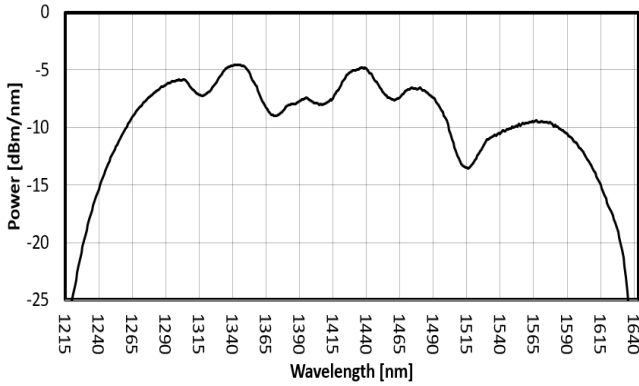

FIG. 2: SLED 1 SPECTRUM

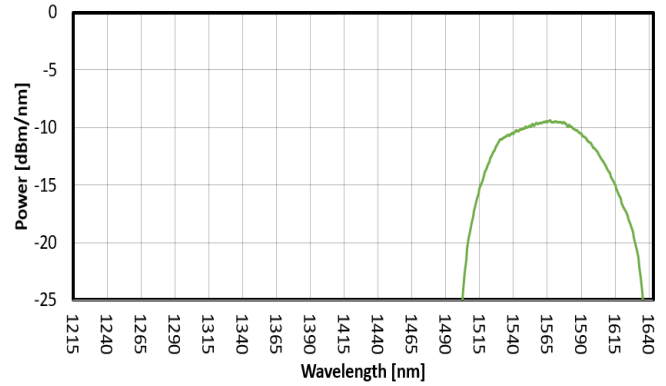

FIG. 3: SLED 2 SPECTRUM

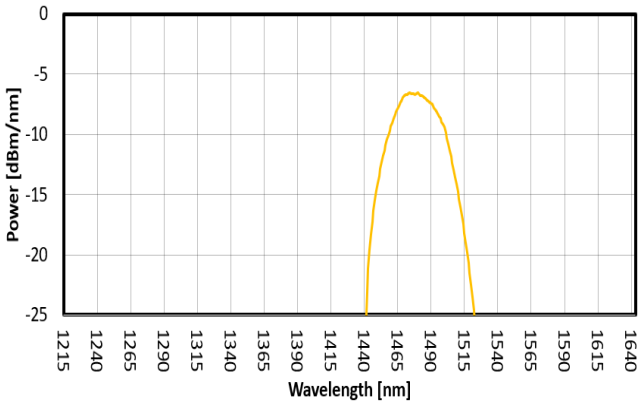

FIG. 4: SLED 3 SPECTRUM

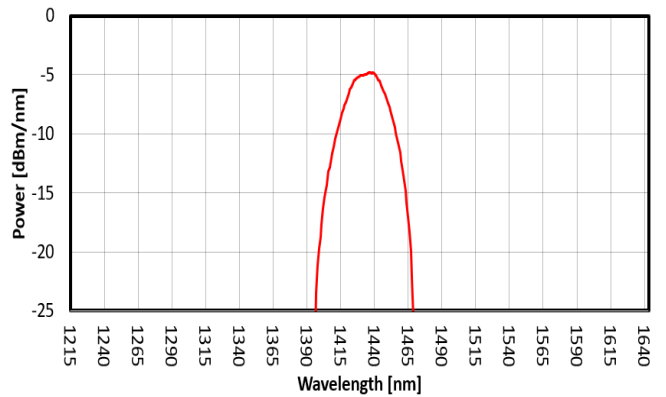

FIG. 5: SLED 4 SPECTRUM

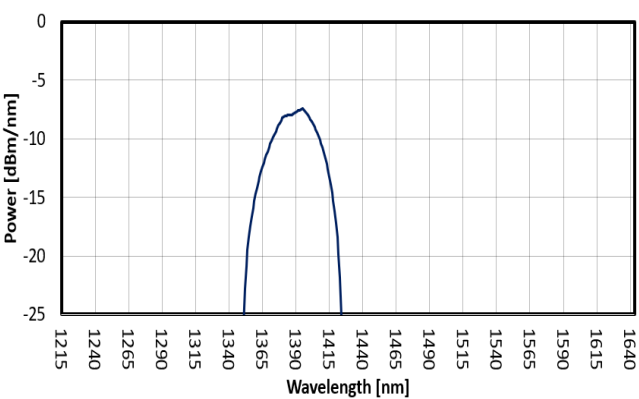

FIG. 6: SLED 5 SPECTRUM

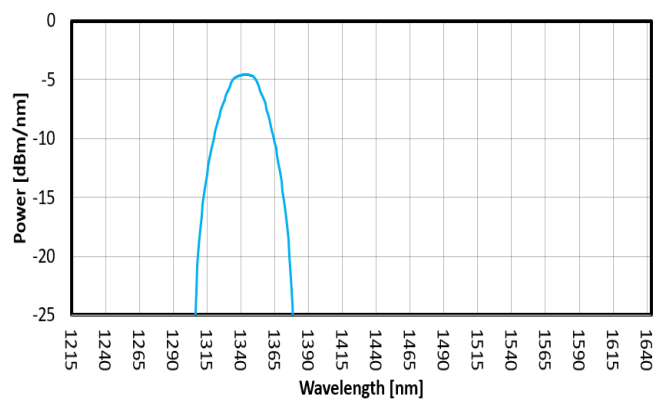

FIG. 7: SLED 6 SPECTRUM

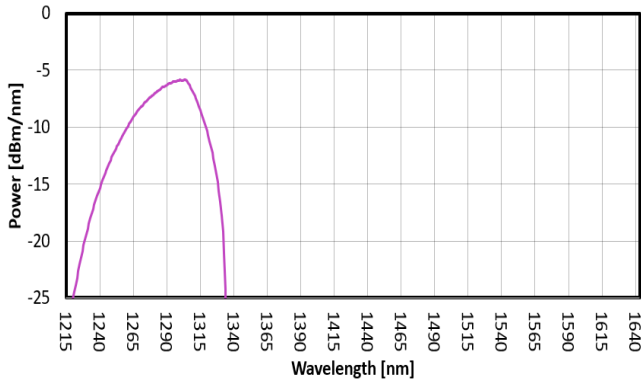

FIG. 8: SLED 1 OUTPUT POWER VS CURRENT

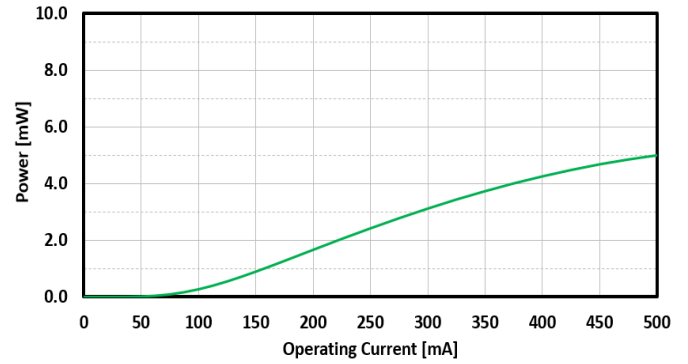

FIG. 9: SLED 2 OUTPUT POWER VS CURRENT

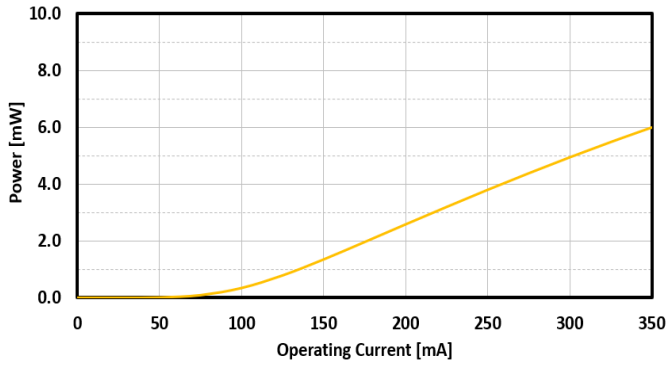

FIG. 10: SLED 3 OUTPUT POWER VS CURRENT

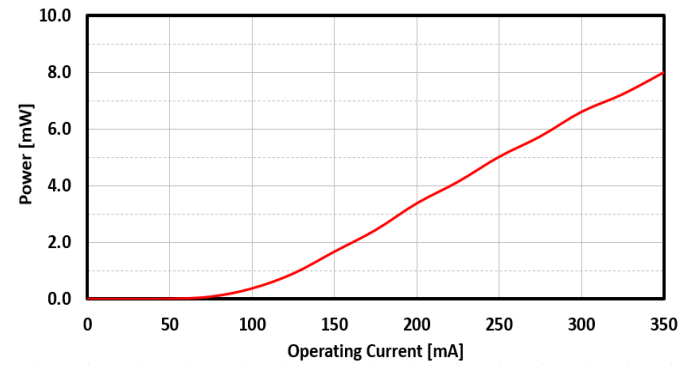

FIG. 11: SLED 4 OUTPUT POWER VS CURRENT

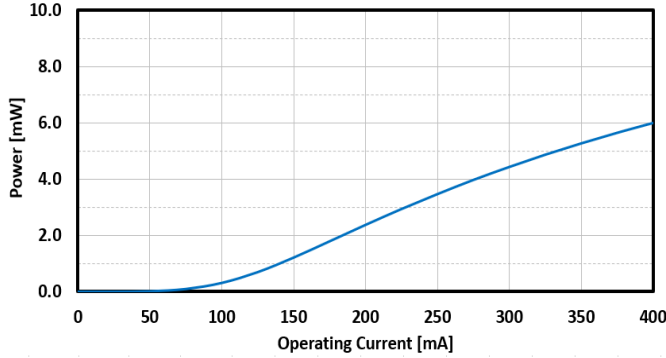

FIG. 12: SLED 5 OUTPUT POWER VS CURRENT

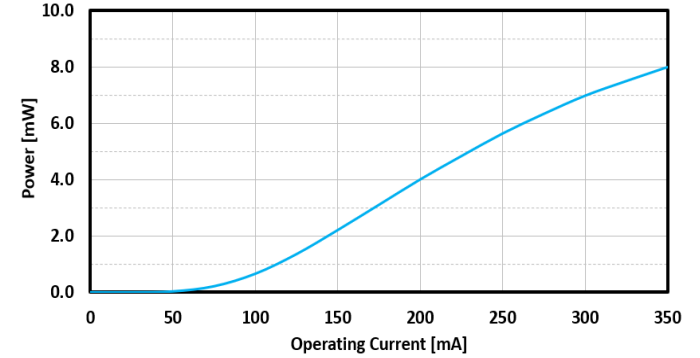

FIG. 13: SLED 6 OUTPUT POWER VS CURRENT

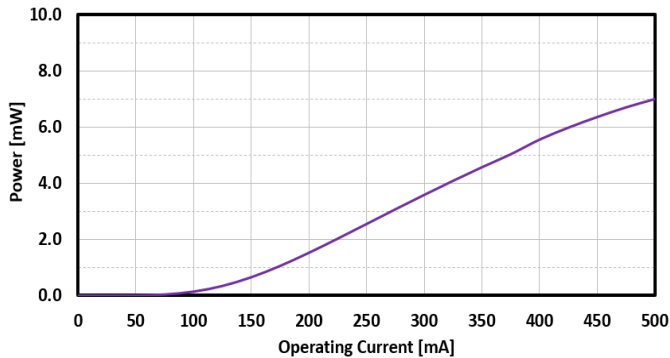

FIG. 14: ISB2 TYPICAL POWER STABILITY

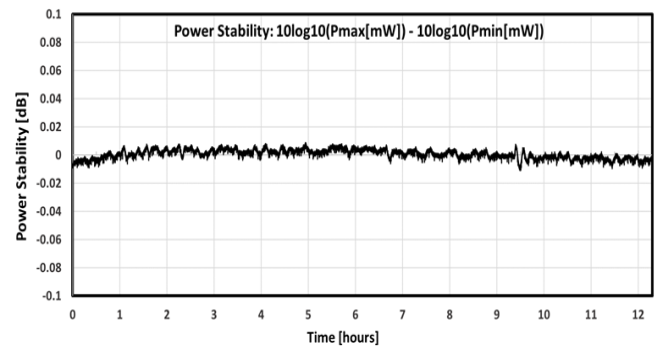
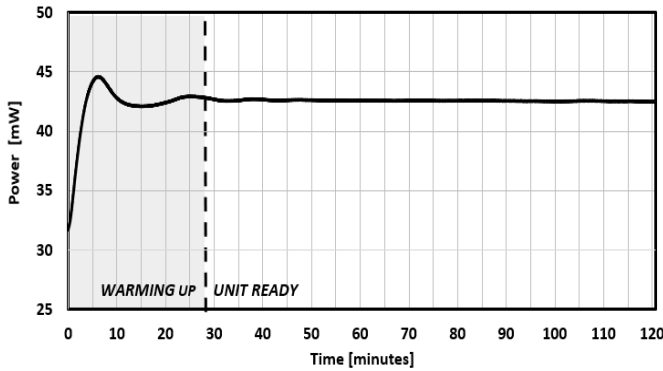

FIG. 15: WARM-UP TIME



G. CONNECTORS



| Item | Description |
|------|--|
| A | FC/APC Connector (Optional: FC/PC, SMA) |
| B | Power Barrel Connector Jack 2.00mm ID, 5.50mm OD, 9.5 mm Length. Center Positive $\ominus - \oplus$ Input: AC 100-240V Output: 12V 5V min |
| C | USB 2.0 Type B |
| D | RJ45 for MODBUS TCP/IP Communication |
| E | D-SUB 9 Positions for RS-232 Communication |
| F | Switches to change between PC Mode - Manual Mode and to turn SLED on when operating in Manual Mode |

H. D-SUB CONNECTOR PIN OUT

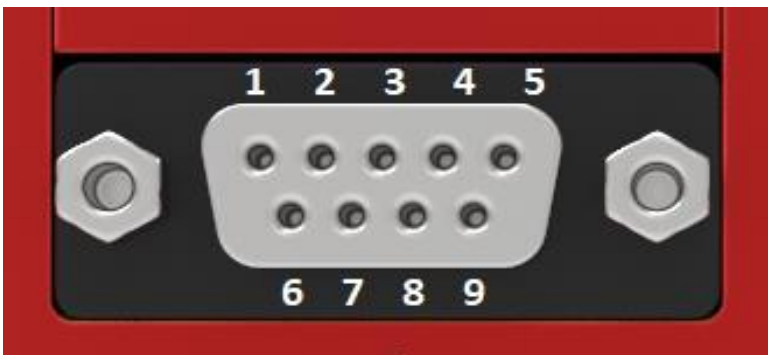

| Pin # | Function RS-232 |
|-------|-----------------|
| 1 | Not used |
| 2 | Tx |
| 3 | Rx |
| 4 | Not used |
| 5 | GND |
| 6 | Not used |
| 7 | Not used |
| 8 | Not used |
| 9 | Not used |

I. MANUAL CONTROL

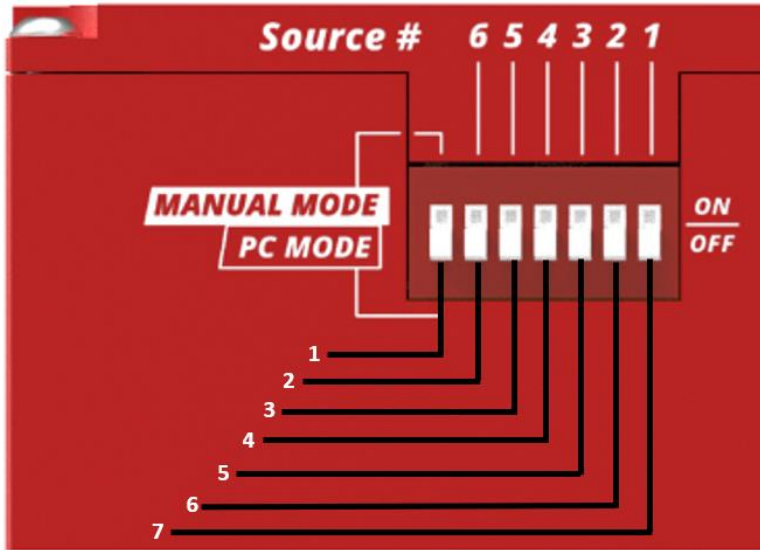

| Pin # | UP | DOWN |
|-------|-----------------------------|-------------------------|
| 1 | Light Source in Manual Mode | Light Source in PC Mode |
| 2 | SLED 6 ON | SLED 6 OFF |
| 3 | SLED 5 ON | SLED 5 OFF |
| 4 | SLED 4 ON | SLED 4 OFF |
| 5 | SLED 3 ON | SLED 3 OFF |
| 6 | SLED 2 ON | SLED 2 OFF |
| 7 | SLED 1 ON | SLED 1 OFF |

J. OSE2 32-PIN BUTTERFLY PACKAGE PIN OUT

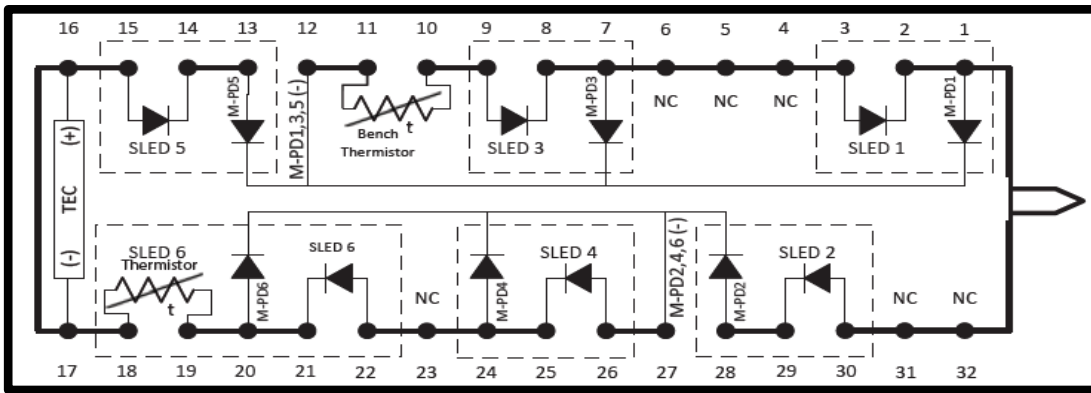

| External Pin Assignment – BeST-SLED: 6 SLEDs | | | | | | | |
|--|------------|----|---------------|----|-------------------|----|---------------|
| 1 | M-PD1 (+) | 9 | SLED 3(+) | 17 | TEC (-) | 25 | SLED 4 (-) |
| 2 | SLED 1 (-) | 10 | Thermistor | 18 | SLED 6 Thermistor | 26 | SLED 4 (+) |
| 3 | SLED 1 (+) | 11 | Thermistor | 19 | SLED 6 Thermistor | 27 | M-PD2,4,6 (-) |
| 4 | NC | 12 | M-PD1,3,5 (-) | 20 | M-PD6 (+) | 28 | M-PD2 (+) |
| 5 | NC | 13 | M-PD5 (+) | 21 | SLED 6 (-) | 29 | SLED 2 (-) |
| 6 | NC | 14 | SLED 5 (-) | 22 | SLED 6 (+) | 30 | SLED 2 (+) |
| 7 | M-PD3 (+) | 15 | SLED 5 (+) | 23 | NC | 31 | NC |
| 8 | SLED 3 (-) | 16 | TEC (+) | 24 | M-PD4 (+) | 32 | NC |

K. MECHANICAL DIAGRAM – STANDARD ISB2

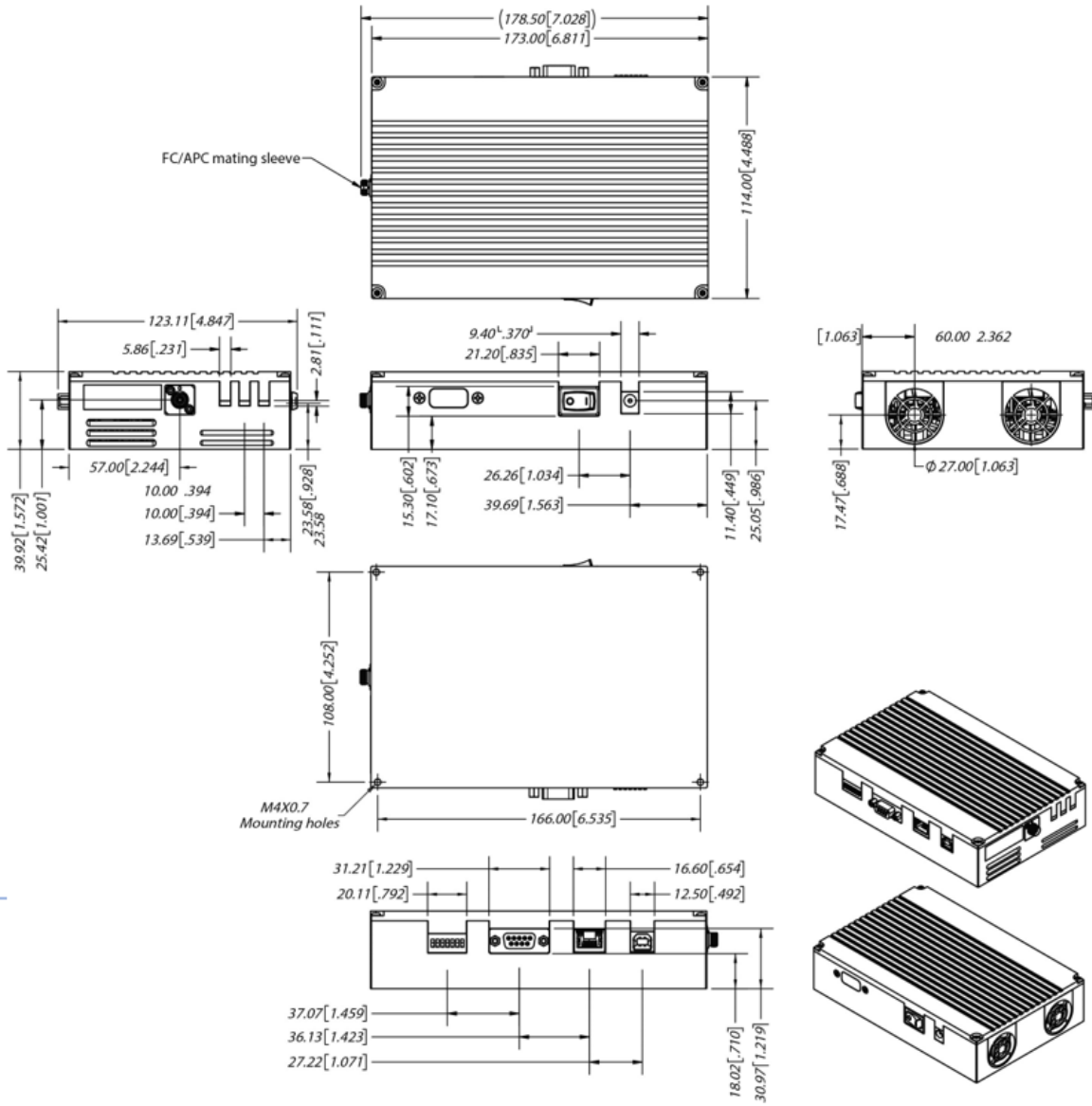

L. MECHANICAL DIAGRAM – STANDARD ISB2 WITH POWER METER

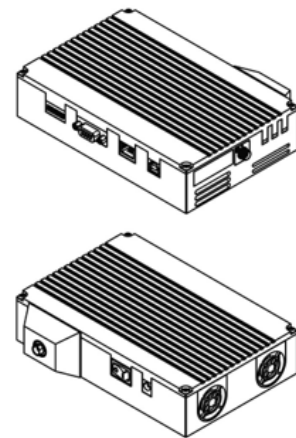
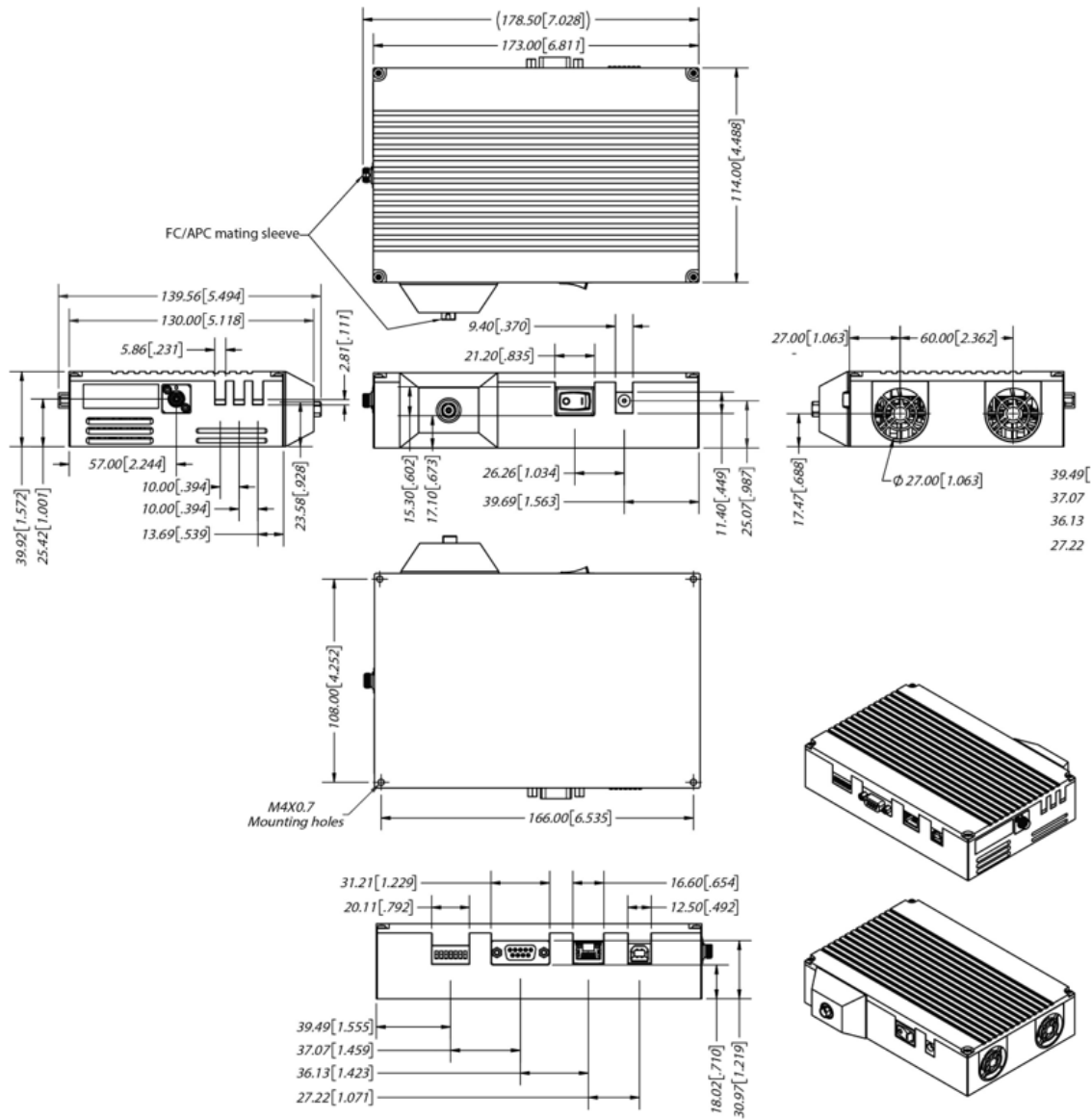

M. SAFETY

All statements regarding safety of operation and technical data will only apply when the unit is operated correctly.

The driver must not be operated in environments susceptible to explosion hazards. Do not obstruct the air ventilation slots. If any parts of the driver, or electronics are broken or exposed, contact Luxmux technical support and do not attempt to operate the unit.

The BeST-SLED® Integrated Spectral Bench (ISB2) is a Class 1M laser product. It is safe for all conditions of use except when passed through magnifying optics such as microscopes and telescopes. It produces a beam that is divergent. If light is re-focused use protective eye wear.

N. APPLICATION PROTOCOL INTERFACE (API)

Luxmux's driver utilizes the MODBUS Protocol for communications. Users can find numerous detailed specifications for the protocol on the internet. MODBUS is used widely in industrial applications. The driver is designed to use this protocol over all of its communication interfaces, MODBUS – RTU is a master/slave protocol and is employed by the USB or RS232 port, and MODBUS - TCP/IP is a client/server protocol and is employed by the Ethernet Interface.

The MODBUS specification has outlined how a user can adapt the overall packet structure to suit each interface requirement. The primary section of a MODBUS packet is known as the Protocol Data Unit (PDU) and it is independent of the underlying communication interface. The PDU includes additional byte fields for the MODBUS transaction per the Application Data Unit (ADU).

A high-level overview of MODBUS Protocol can be found on the BeST-SLED® Integrated Spectral Bench User Manual. If users want to develop their own API, the ISB2 Register Map is available upon request. Please contact technical support: techsupport@luxmux.com.



O. ORDERING CODE

| ORDERING CODE: | | LTC | ISB2 | SLEDs | FT | DOP | SC | FWHM | CW | LOP |
|----------------|---|-----|------|-------|----|-----|----|------|----|-----|
| LTC | Luxmux Technology Corporation | | | | | | | | | |
| ISB2 | Best-SLED® Optical Spectral Engine G2 | | | | | | | | | |
| SLEDs | SLED center wavelength, choose from one of the models in the table 1300nm, 1340nm, 1390nm, 1430nm, 1480nm, 1550nm, 1615nm, 1680nm [choose up to 6] | | | | | | | | | |
| FT | Fiber Type, choose 1: PM: Polarization Maintaining SM: Single Mode FS: Free Space | | | | | | | | | |
| DOP | Degree of Polarization LP: Low Degree of Polarization HP: High Degree of Polarization | | | | | | | | | |
| SC | Spectral Coverage [nm] | | | | | | | | | |
| FWHM | Full Width Half Maximum [nm] [FWHM defined as the bandwidth from the lowest spectral dip] | | | | | | | | | |
| CW | Center Wavelength [nm] | | | | | | | | | |
| LOP | Light Output Power [mW] | | | | | | | | | |

Legend:

- Product Code
- Available Options
- Taken From Table

| Part Number | Ordering Code: LTC-ISB2-(SLEDs)-(FT)-(DOP)-(SC)-(FWHM)-(CW)-(LOP) | SLEDs [nm] | FT | SC [nm] | FWHM [nm] | CW [nm] | LOP [mW] |
|-------------|--|------------------------------------|----|-------------|-----------|---------|----------|
| ASM000501 | LTC-ISB2-1615_1680-PM-HP-1575_1725-150-1650-12 | 1615, 1680 | PM | 1575 - 1725 | 150 | 1650 | 12 |
| ASM000502 | LTC-ISB2-1480_1550_1615-PM-HP-1435_1640-205-1538-18 | 1480, 1550, 1615 | PM | 1435 - 1640 | 205 | 1538 | 18 |
| ASM000503 | LTC-ISB2-1340_1390_1430-PM-HP-1310_1465-155-1388-20 | 1340, 1390, 1430 | PM | 1310 - 1465 | 155 | 1388 | 20 |
| ASM000504 | LTC-ISB2-1300_1340_1390_1430-PM-HP-1265_1465-200-1365-25 | 1300, 1340, 1390, 1430 | PM | 1265 - 1465 | 200 | 1365 | 25 |
| ASM000505 | LTC-ISB2-1480_1550_1615_1680-PM-HP-1435_1725-290-1580-25 | 1480, 1550, 1615, 1680 | PM | 1435 - 1725 | 290 | 1580 | 25 |
| ASM000506 | LTC-ISB2-1300_1340_1390_1430_1480-PM-HP-1265_1500-235-1383-35 | 1300, 1340, 1390, 1430, 1480 | PM | 1265 - 1500 | 235 | 1383 | 35 |
| ASM000507 | LTC-ISB2-1340_1390_1430_1480_1550-PM-HP-1305_1605-300-1455-35 | 1340, 1390, 1430, 1480, 1550 | PM | 1305 - 1605 | 300 | 1455 | 35 |
| ASM000508 | LTC-ISB2-1300_1390_1480_1550_1615_1680-PM-HP-1265_1725-460-1495-40 | 1300, 1390, 1480, 1550, 1615, 1680 | PM | 1265 - 1725 | 460 | 1495 | 40 |
| ASM000509 | LTC-ISB2-1480_1550-PM-HP-1435_1605-170-1520-12 | 1480, 1550 | PM | 1435 - 1605 | 170 | 1520 | 12 |
| ASM000510 | LTC-ISB2-1340_1390_1430_1480_1550_1615-PM-HP-1310_1640-330-1475-38 | 1340, 1390, 1430, 1480, 1550, 1615 | PM | 1310 - 1640 | 330 | 1475 | 38 |
| ASM000511 | LTC-ISB2-1300_1340_1390_1430_1480_1550-PM-HP-1265_1605-340-1435-40 | 1300, 1340, 1390, 1430, 1480, 1550 | PM | 1265 - 1605 | 340 | 1435 | 40 |
| ASM000512 | LTC-ISB2-1430_1480_1550-PM-HP-1410_1605-195-1508-19 | 1430, 1480, 1550 | PM | 1410 - 1605 | 195 | 1508 | 19 |
| ASM000513 | LTC-ISB2-1300_1340_1390-PM-HP-1265_1420-155-1343-20 | 1300, 1340, 1390 | PM | 1265 - 1420 | 155 | 1343 | 20 |
| ASM000514 | LTC-ISB2-1390_1430_1480-PM-HP-1355_1500-145-1428-19 | 1390, 1430, 1480 | PM | 1355 - 1500 | 145 | 1428 | 19 |
| ASM000515 | LTC-ISB2-1550_1615_1680-PM-HP-1515_1725-210-1620-18 | 1550, 1615, 1680 | PM | 1515 - 1725 | 210 | 1620 | 18 |
| ASM000516 | LTC-ISB2-1300_1340-PM-HP-1265_1365-100-1315-12 | 1300, 1340 | PM | 1265 - 1365 | 100 | 1315 | 12 |
| ASM000517 | LTC-ISB2-1390_1480_1550-PM-HP-1340_1610-270-1475-20 | 1390, 1480, 1550 | PM | 1340 - 1610 | 270 | 1475 | 20 |
| ASM000518 | LTC-ISB2-1300_1390_1480-PM-HP-1265_1500-235-1383-20 | 1300, 1390, 1480 | PM | 1265 - 1500 | 235 | 1383 | 20 |
| ASM000519 | LTC-ISB2-1390_1480_1550_1615_1680-PM-HP-1340_1725-385-1533-32 | 1390, 1480, 1550, 1615, 1680 | PM | 1340 - 1725 | 385 | 1533 | 32 |
| ASM000520 | LTC-ISB2-1550_1615-PM-HP-1530_1630-100-1580-10 | 1550, 1615 | PM | 1530 - 1630 | 100 | 1580 | 10 |

#LTC-ISB2-1300_1340_1390_1430_1480_1550-PM-HP-1265_1605-340-1435-40_DS_2021_08_05

This document is the property of Luxmux, and contains proprietary information. Luxmux reserves the right to make product design or specification changes without notice.



Redefining Spectral Boundaries

| Part Number | Ordering Code: LTC-ISB2-(SLED5)-(FT)-(DOP)-(SC)-(FWHM)-(CW)-(LOP) | SLEDs [nm] | FT | SC [nm] | FWHM [nm] | CW [nm] | LOP [mW] |
|-------------|--|------------------------------------|----|-------------|-----------|---------|----------|
| ASM000601 | LTC-ISB2-1615_1680-SM-HP-1575_1725-150-1650-12 | 1615, 1680 | SM | 1575 - 1725 | 150 | 1650 | 12 |
| ASM000602 | LTC-ISB2-1480_1550_1615-SM-HP-1435_1640-205-1538-18 | 1480, 1550, 1615 | SM | 1435 - 1640 | 205 | 1538 | 18 |
| ASM000603 | LTC-ISB2-1340_1390_1430-SM-HP-1310_1465-155-1388-20 | 1340, 1390, 1430 | SM | 1310 - 1465 | 155 | 1388 | 20 |
| ASM000604 | LTC-ISB2-1300_1340_1390_1430-SM-HP-1265_1465-200-1365-25 | 1300, 1340, 1390, 1430 | SM | 1265 - 1465 | 200 | 1365 | 25 |
| ASM000605 | LTC-ISB2-1480_1550_1615_1680-SM-HP-1435_1725-290-1580-25 | 1480, 1550, 1615, 1680 | SM | 1435 - 1725 | 290 | 1580 | 25 |
| ASM000606 | LTC-ISB2-1300_1340_1390_1430_1480-SM-HP-1265_1500-235-1383-35 | 1300, 1340, 1390, 1430, 1480 | SM | 1265 - 1500 | 235 | 1383 | 35 |
| ASM000607 | LTC-ISB2-1340_1390_1430_1480_1550-SM-HP-1305_1605-300-1455-35 | 1340, 1390, 1430, 1480, 1550 | SM | 1305 - 1605 | 300 | 1455 | 35 |
| ASM000608 | LTC-ISB2-1300_1390_1480_1550_1615_1680-SM-HP-1265_1725-460-1495-40 | 1300, 1390, 1480, 1550, 1615, 1680 | SM | 1265 - 1725 | 460 | 1495 | 40 |
| ASM000609 | LTC-ISB2-1480_1550-SM-HP-1435_1605-170-1520-12 | 1480, 1550 | SM | 1435 - 1605 | 170 | 1520 | 12 |
| ASM000610 | LTC-ISB2-1340_1390_1430_1480_1550_1615-SM-HP-1310_1640-330-1475-38 | 1340, 1390, 1430, 1480, 1550, 1615 | SM | 1310 - 1640 | 330 | 1475 | 38 |
| ASM000611 | LTC-ISB2-1300_1340_1390_1430_1480_1550-SM-HP-1265_1605-340-1435-40 | 1300, 1340, 1390, 1430, 1480, 1550 | SM | 1265 - 1605 | 340 | 1435 | 40 |
| ASM000612 | LTC-ISB2-1430_1480_1550-SM-HP-1410_1605-195-1508-19 | 1430, 1480, 1550 | SM | 1410 - 1605 | 195 | 1508 | 19 |
| ASM000613 | LTC-ISB2-1300_1340_1390-SM-HP-1265_1420-155-1343-20 | 1300, 1340, 1390 | SM | 1265 - 1420 | 155 | 1343 | 20 |
| ASM000614 | LTC-ISB2-1390_1430_1480-SM-HP-1355_1500-145-1428-19 | 1390, 1430, 1480 | SM | 1355 - 1500 | 145 | 1428 | 19 |
| ASM000615 | LTC-ISB2-1550_1615_1680-SM-HP-1515_1725-210-1620-18 | 1550, 1615, 1680 | SM | 1515 - 1725 | 210 | 1620 | 18 |
| ASM000616 | LTC-ISB2-1300_1340-SM-HP-1265_1365-100-1315-12 | 1300, 1340 | SM | 1265 - 1365 | 100 | 1315 | 12 |
| ASM000617 | LTC-ISB2-1390_1480_1550-SM-HP-1340_1610-270-1475-20 | 1390, 1480, 1550 | SM | 1340 - 1610 | 270 | 1475 | 20 |
| ASM000618 | LTC-ISB2-1300_1390_1480-SM-HP-1265_1500-235-1383-20 | 1300, 1390, 1480 | SM | 1265 - 1500 | 235 | 1383 | 20 |
| ASM000619 | LTC-ISB2-1390_1480_1550_1615_1680-SM-HP-1340_1725-385-1533-32 | 1390, 1480, 1550, 1615, 1680 | SM | 1340 - 1725 | 385 | 1533 | 32 |
| ASM000620 | LTC-ISB2-1550_1615-SM-HP-1530_1630-100-1580-10 | 1550, 1615 | SM | 1530 - 1630 | 100 | 1580 | 10 |

| Part Number | Ordering Code: LTC-ISB2-(SLED5)-(FT)-(DOP)-(SC)-(FWHM)-(CW)-(LOP) | SLEDs [nm] | FT | SC [nm] | FWHM [nm] | CW [nm] | LOP [mW] |
|-------------|--|------------------------------------|----|-------------|-----------|---------|----------|
| ASM000701 | LTC-ISB2-1615_1680-SM-LP-1575_1725-150-1650-12 | 1615, 1680 | SM | 1575 - 1725 | 150 | 1650 | 12 |
| ASM000702 | LTC-ISB2-1480_1550_1615-SM-LP-1435_1640-205-1538-18 | 1480, 1550, 1615 | SM | 1435 - 1640 | 205 | 1538 | 18 |
| ASM000703 | LTC-ISB2-1340_1390_1430-SM-LP-1310_1465-155-1388-20 | 1340, 1390, 1430 | SM | 1310 - 1465 | 155 | 1388 | 20 |
| ASM000704 | LTC-ISB2-1300_1340_1390_1430-SM-LP-1265_1465-200-1365-25 | 1300, 1340, 1390, 1430 | SM | 1265 - 1465 | 200 | 1365 | 25 |
| ASM000705 | LTC-ISB2-1480_1550_1615_1680-SM-LP-1435_1725-290-1580-25 | 1480, 1550, 1615, 1680 | SM | 1435 - 1725 | 290 | 1580 | 25 |
| ASM000706 | LTC-ISB2-1300_1340_1390_1430_1480-SM-LP-1265_1500-235-1383-35 | 1300, 1340, 1390, 1430, 1480 | SM | 1265 - 1500 | 235 | 1383 | 35 |
| ASM000707 | LTC-ISB2-1340_1390_1430_1480_1550-SM-LP-1305_1605-300-1455-35 | 1340, 1390, 1430, 1480, 1550 | SM | 1305 - 1605 | 300 | 1455 | 35 |
| ASM000708 | LTC-ISB2-1300_1390_1480_1550_1615_1680-SM-LP-1265_1725-460-1495-40 | 1300, 1390, 1480, 1550, 1615, 1680 | SM | 1265 - 1725 | 460 | 1495 | 40 |
| ASM000709 | LTC-ISB2-1480_1550-SM-LP-1435_1605-170-1520-12 | 1480, 1550 | SM | 1435 - 1605 | 170 | 1520 | 12 |
| ASM000710 | LTC-ISB2-1340_1390_1430_1480_1550_1615-SM-LP-1310_1640-330-1475-38 | 1340, 1390, 1430, 1480, 1550, 1615 | SM | 1310 - 1640 | 330 | 1475 | 38 |
| ASM000711 | LTC-ISB2-1300_1340_1390_1430_1480_1550-SM-LP-1265_1605-340-1435-40 | 1300, 1340, 1390, 1430, 1480, 1550 | SM | 1265 - 1605 | 340 | 1435 | 40 |
| ASM000712 | LTC-ISB2-1430_1480_1550-SM-LP-1410_1605-195-1508-19 | 1430, 1480, 1550 | SM | 1410 - 1605 | 195 | 1508 | 19 |
| ASM000713 | LTC-ISB2-1300_1340_1390-SM-LP-1265_1420-155-1343-20 | 1300, 1340, 1390 | SM | 1265 - 1420 | 155 | 1343 | 20 |
| ASM000714 | LTC-ISB2-1390_1430_1480-SM-LP-1355_1500-145-1428-19 | 1390, 1430, 1480 | SM | 1355 - 1500 | 145 | 1428 | 19 |
| ASM000715 | LTC-ISB2-1550_1615_1680-SM-LP-1515_1725-210-1620-18 | 1550, 1615, 1680 | SM | 1515 - 1725 | 210 | 1620 | 18 |
| ASM000716 | LTC-ISB2-1300_1340-SM-LP-1265_1365-100-1315-12 | 1300, 1340 | SM | 1265 - 1365 | 100 | 1315 | 12 |
| ASM000717 | LTC-ISB2-1390_1480_1550-SM-LP-1340_1610-270-1475-20 | 1390, 1480, 1550 | SM | 1340 - 1610 | 270 | 1475 | 20 |
| ASM000718 | LTC-ISB2-1300_1390_1480-SM-LP-1265_1500-235-1383-20 | 1300, 1390, 1480 | SM | 1265 - 1500 | 235 | 1383 | 20 |
| ASM000719 | LTC-ISB2-1390_1480_1550_1615_1680-SM-LP-1340_1725-385-1533-32 | 1390, 1480, 1550, 1615, 1680 | SM | 1340 - 1725 | 385 | 1533 | 32 |
| ASM000720 | LTC-ISB2-1550_1615-SM-LP-1530_1630-100-1580-10 | 1550, 1615 | SM | 1530 - 1630 | 100 | 1580 | 10 |

#LTC-ISB2-1300_1340_1390_1430_1480_1550-PM-HP-1265_1605-340-1435-40_DS_2021_08_05

This document is the property of Luxmux, and contains proprietary information. Luxmux reserves the right to make product design or specification changes without notice.



Redefining Spectral Boundaries

| Part Number | Ordering Code: LTC-ISB2-(SLEDS)-(FT)-(DOP)-(SC)-(FWHM)-(CW)-(LOP) | SLEDs [nm] | FT | SC [nm] | FWHM [nm] | CW [nm] | LOP [mW] |
|-------------|---|------------------------------------|----|-------------|-----------|---------|----------|
| ASM000801 | LTC-ISB2-1615_1680-FS-HP-1575_1725-150-1650-35 | 1615, 1680 | FS | 1575 - 1725 | 150 | 1650 | 35 |
| ASM000802 | LTC-ISB2-1480_1550_1615-FS-HP-1435_1640-205-1538-55 | 1480, 1550, 1615 | FS | 1435 - 1640 | 205 | 1538 | 55 |
| ASM000803 | LTC-ISB2-1340_1390_1430-FS-HP-1310_1465-155-1388-65 | 1340, 1390, 1430 | FS | 1310 - 1465 | 155 | 1388 | 65 |
| ASM000804 | LTC-ISB2-1300_1340_1390_1430-FS-HP-1265_1465-200-1365-90 | 1300, 1340, 1390, 1430 | FS | 1265 - 1465 | 200 | 1365 | 90 |
| ASM000805 | LTC-ISB2-1480_1550_1615_1680-FS-HP-1435_1725-290-1580-80 | 1480, 1550, 1615, 1680 | FS | 1435 - 1725 | 290 | 1580 | 80 |
| ASM000806 | LTC-ISB2-1300_1340_1390_1430_1480-FS-HP-1265_1500-235-1383-115 | 1300, 1340, 1390, 1430, 1480 | FS | 1265 - 1500 | 235 | 1383 | 115 |
| ASM000807 | LTC-ISB2-1340_1390_1430_1480_1550-FS-HP-1305_1605-300-1455-110 | 1340, 1390, 1430, 1480, 1550 | FS | 1305 - 1605 | 300 | 1455 | 110 |
| ASM000808 | LTC-ISB2-1300_1390_1480_1550_1615_1680-FS-HP-1265_1725-460-1495-125 | 1300, 1390, 1480, 1550, 1615, 1680 | FS | 1265 - 1725 | 460 | 1495 | 125 |
| ASM000809 | LTC-ISB2-1480_1550-FS-HP-1435_1605-170-1520-45 | 1480, 1550 | FS | 1435 - 1605 | 170 | 1520 | 45 |
| ASM000810 | LTC-ISB2-1340_1390_1430_1480_1550_1615-FS-HP-1310_1640-330-1475-120 | 1340, 1390, 1430, 1480, 1550, 1615 | FS | 1310 - 1640 | 330 | 1475 | 120 |
| ASM000811 | LTC-ISB2-1300_1340_1390_1430_1480_1550-FS-HP-1265_1605-340-1435-130 | 1300, 1340, 1390, 1430, 1480, 1550 | FS | 1265 - 1605 | 340 | 1435 | 130 |
| ASM000812 | LTC-ISB2-1430_1480_1550-FS-HP-1410_1605-195-1508-60 | 1430, 1480, 1550 | FS | 1410 - 1605 | 195 | 1508 | 60 |
| ASM000813 | LTC-ISB2-1300_1340_1390-FS-HP-1265_1420-155-1343-70 | 1300, 1340, 1390 | FS | 1265 - 1420 | 155 | 1343 | 70 |
| ASM000814 | LTC-ISB2-1390_1430_1480-FS-HP-1355_1500-145-1428-65 | 1390, 1430, 1480 | FS | 1355 - 1500 | 145 | 1428 | 65 |
| ASM000815 | LTC-ISB2-1550_1615_1680-FS-HP-1515_1725-210-1620-55 | 1550, 1615, 1680 | FS | 1515 - 1725 | 210 | 1620 | 55 |
| ASM000816 | LTC-ISB2-1300_1340-FS-HP-1265_1365-100-1315-50 | 1300, 1340 | FS | 1265 - 1365 | 100 | 1315 | 50 |
| ASM000817 | LTC-ISB2-1390_1480_1550-FS-HP-1340_1610-270-1475-60 | 1390, 1480, 1550 | FS | 1340 - 1610 | 270 | 1475 | 60 |
| ASM000818 | LTC-ISB2-1300_1390_1480-FS-HP-1265_1500-235-1383-70 | 1300, 1390, 1480 | FS | 1265 - 1500 | 235 | 1383 | 70 |
| ASM000819 | LTC-ISB2-1390_1480_1550_1615_1680-FS-HP-1340_1725-385-1533-100 | 1390, 1480, 1550, 1615, 1680 | FS | 1340 - 1725 | 385 | 1533 | 100 |
| ASM000820 | LTC-ISB2-1550_1615-FS-HP-1530_1630-100-1580-30 | 1550, 1615 | FS | 1530 - 1630 | 100 | 1580 | 30 |

#LTC-ISB2-1300_1340_1390_1430_1480_1550-PM-HP-1265_1605-340-1435-40_DS_2021_08_05

This document is the property of Luxmux, and contains proprietary information. Luxmux reserves the right to make product design or specification changes without notice.