

## 5ACM\_4 series

5W- Single Output AC-DC Converter - Universal Input - Isolated & Regulated

### AC-DC Converter 5 Watt

- ⊕ Wide input voltage range: 85~264VAC/100~400VDC
- ⊕ Over current protection
- ⊕ Short circuit protection (SCP)
- ⊕ High efficiency
- ⊕ High safety isolation 4000VAC
- ⊕ Ultra-slim SIP package
- ⊕ Industrial grade
- ⊕ IEC62368/EN62368/UL62368 approval

The 5ACM\_4 series is a high efficiency green power modules provided by GAPTEC. The features of this series are: Accept either AC or DC input, wide input voltage, high efficiency, low power consumption, safety isolation etc. All models are particularly suitable for the applications such as industrial, electric power, instrumentation, smart home which do not have high requirement on EMC. EMC application circuit must be added if the products need to be applied to EMC harsh environment.



#### Common specifications

Short circuit protection:	Continuous, automatic recovery
Temperature rise at full load:	25°C TYP
Cooling:	Free air convection
Operation temperature range:	-25°C – +85°C
Storage temperature range:	-40°C – +105°C
Welding temperature:	Wave-soldering: 260±5°C; time:5~10s Manual-welding: 360±10°C; time:3~5s
Storage humidity range:	105% (max.)
Power derating:	-25°C ~ 0°C: 0.8%/°C MIN 55°C ~ 85°C: 1.33%/°C MIN
Safety standard:	IEC62368/EN62368/UL62368
Safety-regulated certification:	EN62368/UL62368
Safety class:	Class II
Hot plug:	Unavailable
Case material:	Plastic [UL94-V0]
MTBF (MIL-HDBK-217F@25°C):	>300,000 hours
Weight:	7g

#### Input specifications

Item	Test condition	Min	Typ	Max	Units
Input voltage range	• Conventional	100		240	VAC
	• AC Input	85		264	VAC
	• DC Input	100		400	VDC
Input frequency		47		63	Hz
Input current	• 115VAC			0.2	A
	• 230VAC			0.1	A
Inrush current	• 115VAC		5		A
	• 230VAC		10		A
Leakage current	CY0 is 1nF/400VAC			0.25	mA

#### Isolation specifications

Item	Test condition	Min	Typ	Max	Units
Isolation voltage	Input-Output, tested for 1 minute	4000			VAC

#### Output specifications

Item	Operating condition	Min	Typ	Max	Units
Output voltage accuracy	• 3.3V output		±2	±3	%
	• Others		±1	±2	%
Line regulation	Full load		±0.5		%
Load regulation	10% to 100% load		±1	±1.5	%
Temperature drift	100% full load		±0.02		%/°C
Ripple & Noise*	20MHz Bandwidth (peak-peak value)		50	150	mV
Stand-by Power				0.5	W
Over-current Protection	≥150%Io self-recovery				
Over-voltage Protection	3.3/5V output =	≤ 7.5 V (Output voltage clamp)			
	9V output =	≤ 15 V (Output voltage clamp)			
	12/15V output =	≤ 20 V (Output voltage clamp)			
	24V output =	≤ 30 V (Output voltage clamp)			
Min. load		0			%
Switching frequency	Full load, nominal input			60	KHz
Hold-up time	• 115VAC input		15		ms
	• 230VAC input		75		ms

#### Example:

**5ACM\_05S4**  
 5 = 5Watt; AC = AC-DC; M = case style; 5Vout; S = Single Output;  
 4 = 4kVAC isolation

#### Note:

- Module required dispensing fixed after assembled;
- This part is open frame, at least 6.4mm safety distance between the the primary and secondary external components of the module is needed to meet the safety requirement;
- All specifications were measured at Ta = 25°C, humidity <75%, nominal input voltage and rated output load unless otherwise specified;
- All index testing methods in this datasheet are based on our Company's corporate standards;
- The performance indexes of the product models listed in this manual are as above, but some indexes of non-standard model products will exceed the abovementioned requirements, and please directly contact our technician for specific information;
- We can provide product customization service;
- Specifications of this product are subject to changes without prior notice.

## 5ACM\_4 series

5W- Single Output AC-DC Converter - Universal Input - Isolated & Regulated

Approval	Model	Power [W]	Nominal Output [Vo]	Current Output [Io]	Efficiency [%, typ]	Capacitive load [ $\mu$ F, max]
UL/CE/CB	5ACM_03S4	3.3	3.3V	1A	67	2200
UL/CE/CB	5ACM_05S4	5	5V	1A	74	1500
UL/CE/CB	5ACM_09S4	5	9V	0.56A	75	680
UL/CE/CB	5ACM_12S4	5	12V	0.42A	76	470
UL/CE/CB	5ACM_15S4	5	15V	0.34A	77	330
UL/CE/CB	5ACM_24S4	5	24V	0.21A	79	100

### EMC specifications

EMC / EMI / Conducted disturbance	CISPR32/EN55032, CISPR32/EN55032,	CLASS A (see Typical application circuit) CLASS B (see EMC solution-recommended circuit)
EMC / EMI / Radiated emission	CISPR32/EN55032,	CLASS B (see Typical application circuit or EMC solution-recommended circuit)
EMC / EMS / Electrostatic discharge	IEC/EN 61000-4-2	contact $\pm$ 6KV perf. Criteria B
EMC / EMS / Radiation Immunity	IEC/EN 61000-4-3	10V/m perf. Criteria A
EMC / EMS / EFT	IEC/EN 61000-4-4 IEC/EN 61000-4-4	$\pm$ 2kV (see Typical application circuit) $\pm$ 4kV (see EMC solution-recommended circuit) perf. Criteria B perf. Criteria B
EMC / EMS / Surge Immunity	IEC/EN 61000-4-5	$\pm$ 1KV/ $\pm$ 2KV (see Typical application circuit or EMC solution-recommended circuit) perf. Criteria B
EMC / EMS / Conducted disturbance	IEC/EN 61000-4-6	10 Vr.m.s (see EMC solution-recommended circuit) perf. Criteria A
EMC / EMS / Immunity for power	IEC/EN 61000-4-8	10A/m perf. Criteria A
EMC / EMS / Voltage dips, short and drop interruptions immunity	IEC/EN 61000-4-11	0%-70% perf. Criteria B

## Product typical curve

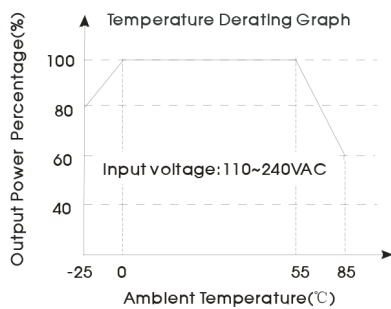

Note: Input voltage should be derated based on temperature derating when it is 85~110VAC / 240~264VAC.

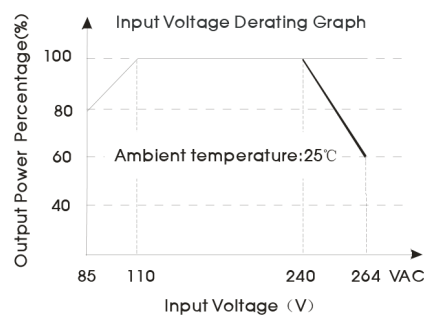

Note: When Input DC, VDC=1.414VAC-20.

## Efficiency

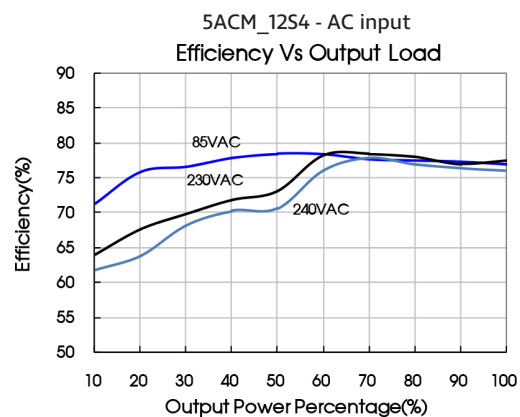
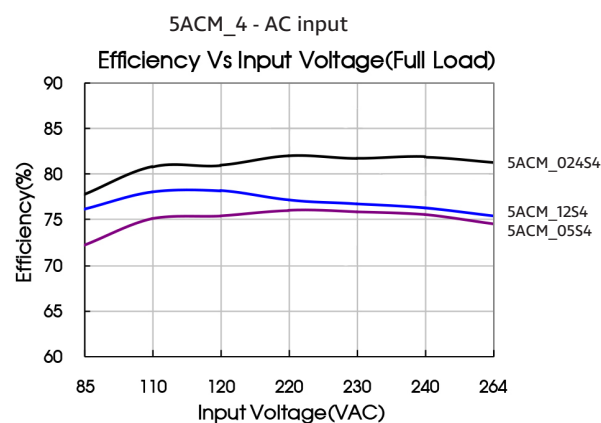

## 5ACM\_4 series

5W- Single Output AC-DC Converter - Universal Input - Isolated & Regulated

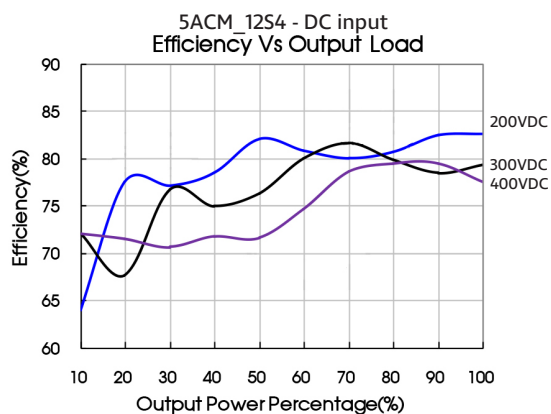
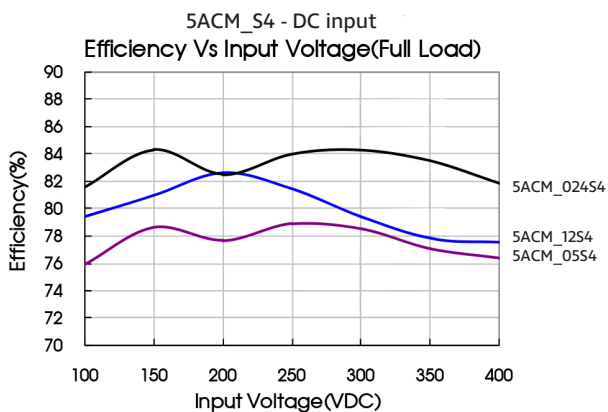

## Typical application circuit

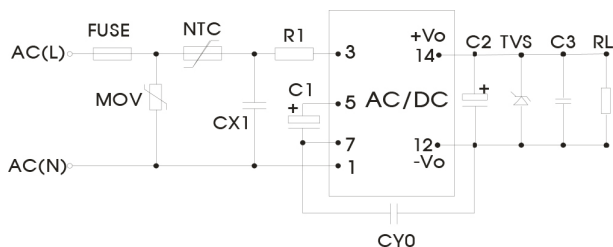

Fig. 1: Typical application circuit

Model	C1 (required)	C2 (required)	R1	C3	CX1	CY0	NTC	MOV	Fuse (required)	TVS
5ACM_0354	10 $\mu$ F/400V	220 $\mu$ F/35V	12 $\Omega$ /2W	100nF/50V	0.1 $\mu$ F/275VAC	1nF/400VAC	13D-5	S14K350	1A/250V	SMBJ7.0A
5ACM_0554	10 $\mu$ F/400V	220 $\mu$ F/35V	12 $\Omega$ /2W	100nF/50V	0.1 $\mu$ F/275VAC	1nF/400VAC	13D-5	S14K350	1A/250V	SMBJ7.0A
5ACM_0954	10 $\mu$ F/400V	220 $\mu$ F/35V	12 $\Omega$ /2W	100nF/50V	0.1 $\mu$ F/275VAC	1nF/400VAC	13D-5	S14K350	1A/250V	SMBJ12A
5ACM_1254	10 $\mu$ F/400V	150 $\mu$ F/35V	12 $\Omega$ /2W	100nF/50V	0.1 $\mu$ F/275VAC	1nF/400VAC	13D-5	S14K350	1A/250V	SMBJ20A
5ACM_1554	10 $\mu$ F/400V	150 $\mu$ F/35V	12 $\Omega$ /2W	100nF/50V	0.1 $\mu$ F/275VAC	1nF/400VAC	13D-5	S14K350	1A/250V	SMBJ20A
5ACM_2454	10 $\mu$ F/400V	150 $\mu$ F/35V	12 $\Omega$ /2W	100nF/50V	0.1 $\mu$ F/275VAC	1nF/400VAC	13D-5	S14K350	1A/250V	SMBJ30A

Note:

1. C1:

When AC input, C1 is used as filter capacitor, the value of C1 is recommended to be 10 $\mu$ F /400V.

When DC input, C1 is used as EMC filter capacitor, the value of C1 is recommended to be 10 $\mu$ F/400V(when the input voltage is above 370VDC, the recommended value of C1 is 10 $\mu$ F/450V).

2. Output filtering capacitor C2 is electrolytic capacitor, C2 is recommended to apply electrolytic capacitor with high frequency and low resistance. For capacitance and current of capacitor please refer to manufacture's datasheet. Capacitance withstand voltage derating should be 80% or above. C3 is ceramic capacitor, which is used to filter high-frequency noise.

## EMC solution-recommended circuit

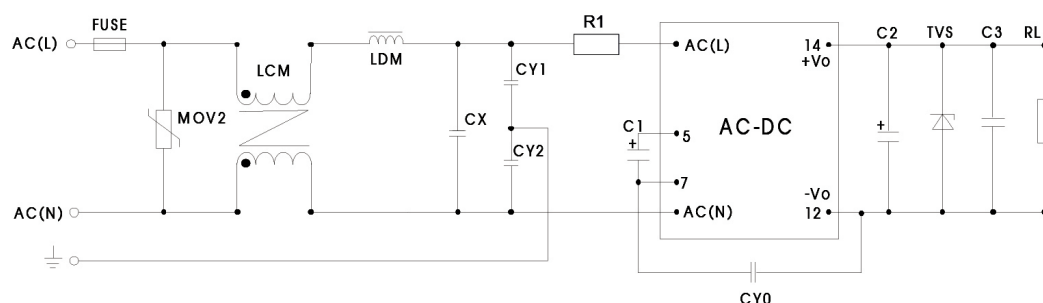

## 5ACM\_4 series

5W- Single Output AC-DC Converter - Universal Input - Isolated & Regulated

### EMC recommended circuit PCB layout

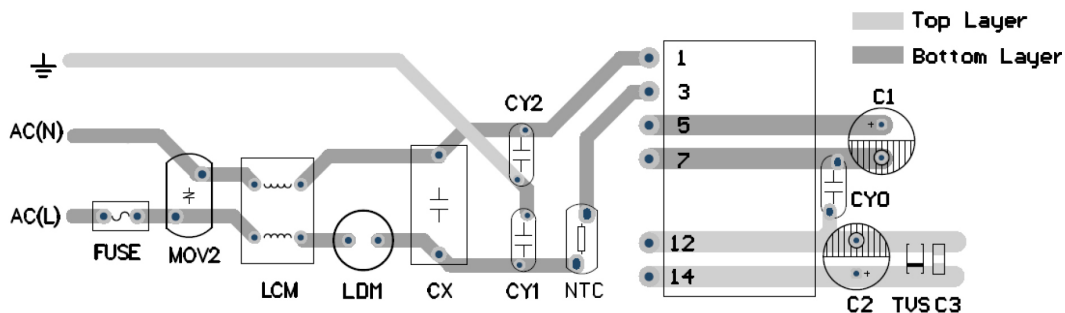

Suggestions for safety regulation and wiring width: wire width  $\geq 3\text{mm}$ , distance between wires  $\geq 6\text{mm}$ , and distance between wire and ground  $\geq 6\text{mm}$

Components	Recommended parameter
MOV2	S14K320
CY1, CY2	1nF/400VAC
CX	0.1 $\mu\text{F}$ /275VAC
LCM	3.5mH
LDM	330 $\mu\text{H}$
R1	12 $\Omega$ /2W
Fuse (required)	1A/250V, slow fusing

### Mechanical dimensions

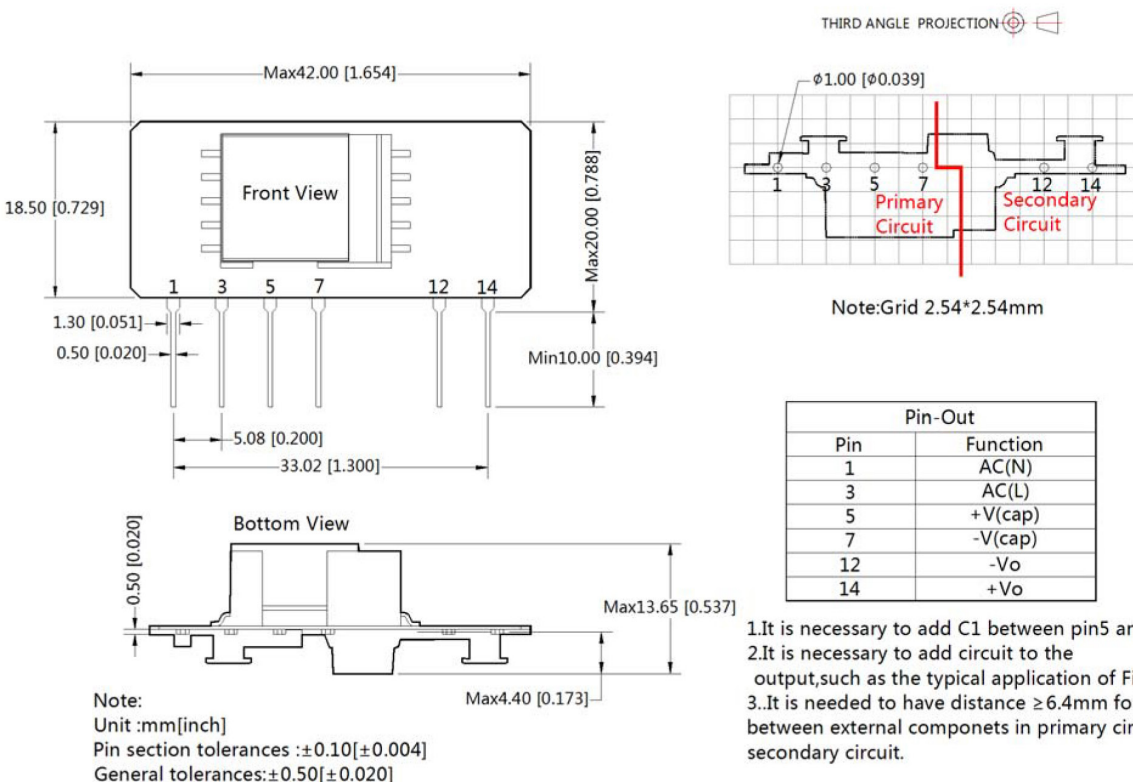

- 1.It is necessary to add C1 between pin5 and pin7.
- 2.It is necessary to add circuit to the output,such as the typical application of Figure 1.
- 3.It is needed to have distance  $\geq 6.4\text{mm}$  for safety between external componets in primary circuit and secondary circuit.