

GENERAL DESCRIPTION

The XRP6657 is a high efficiency synchronous step down DC to DC converter capable of delivering up to 1.5 Amp of current and optimized for portable battery-operated applications.

Operating over an input voltage range of 2.5V to 5.5V, it provides an adjustable regulated output voltage down to 0.6V. The XRP6657 uses a constant 1.3 MHz frequency pulse width modulation (PWM) scheme allowing for compact external components, low output voltage ripple and fixed frequency noise, while Pulse Skip Mode (PSM) is used to improve light load efficiency. A low dropout mode provides 100% duty cycle operation.

The solution footprint is further reduced by a current mode internal compensation network and built-in synchronous switch removing the need for an external Schottky. Over-current and over-temperature protection insures safe operations under abnormal operating conditions.

The XRP6657 is available in a compact RoHS compliant "green"/halogen free thin 6-pin DFN package.

APPLICATIONS

- Point of Loads
- Set-Top Boxes
- Portable Media Players
- Hard Disk Drives

FEATURES

- **Guaranteed 1.5A Output Current**
 - Fixed 1.3MHz Frequency PWM Operations
 - Up to 95% efficiency
 - Input Voltage: 2.5V to 5.5V
- **Adjustable Output Voltage**
- **Internal Compensation Network**
- **No Schottky Diode Required**
- **LDO Operation: 100% Duty Cycle**
- **240 μ A Quiescent Current (no load)**
- **1 μ A Shutdown Current**
- **Soft Start Function**
- **Over-current/Over-temperature Protection**
- **"Green"/Halogen Free DFN-6 Package**

TYPICAL APPLICATION DIAGRAM

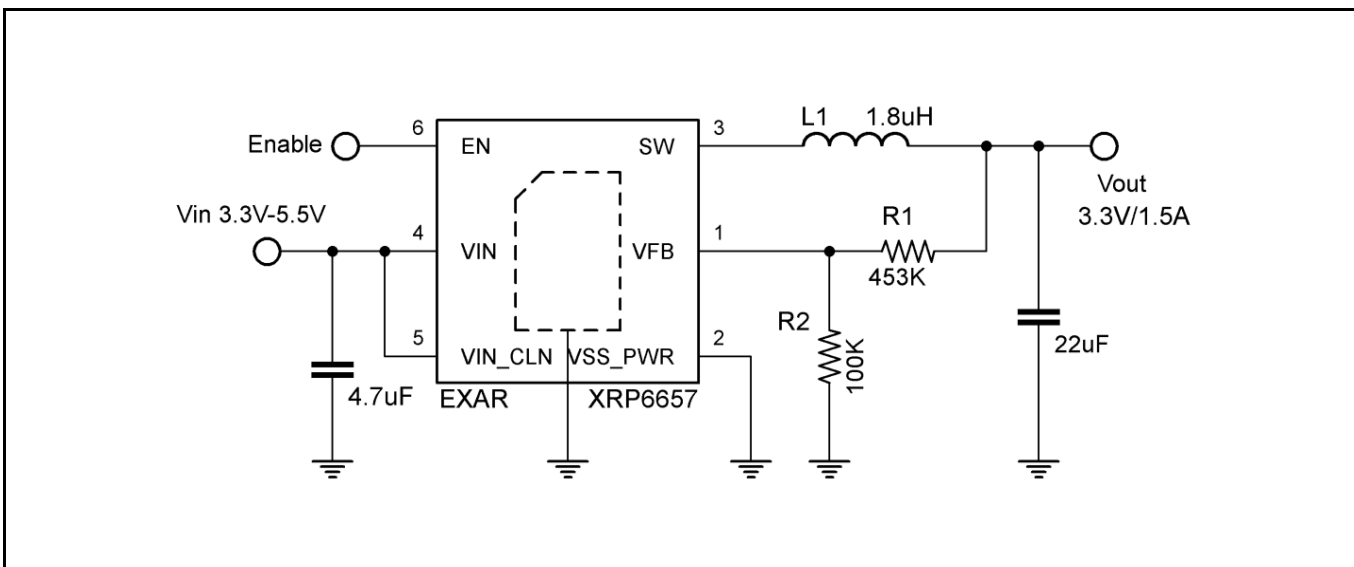

Fig. 1: XRP6657 Application Diagram

1.5A 1.3MHz Synchronous Step Down Converter

ABSOLUTE MAXIMUM RATINGS

These are stress ratings only and functional operation of the device at these ratings or any other above those indicated in the operation sections of the specifications below is not implied. Exposure to absolute maximum rating conditions for extended periods of time may affect reliability.

Input Voltage V_{IN} -0.3V to 6.0V
 EN, V_{FB} Voltage -0.3V to V_{IN}
 SW Voltage..... -0.3V to ($V_{IN}+0.3V$)
 PMOS Switch Source Current (DC)..... 2A
 NMOS Switch Sink Current (DC)..... 2A
 Peak Switch Sink and Source Current..... 3.5A
 Lead Temperature (Soldering, 10 sec) 260°C
 Storage Temp. Range T_{STG} -65°C to 150°C
 ESD Rating (HBM - Human Body Model) 2kV
 ESD Rating (MM - Machine Model) 200V

OPERATING RATINGS

Input Voltage Range V_{IN}2.5V to 5.5V
 Ambient Temperature Range T_A -40°C to 85°C
 Junction Temperature Range T_J-40°C to 125°C
 Thermal Resistance θ_{JC} 10°C/W
 Thermal Resistance θ_{JA} 55°C/W

Note 1: T_J is a function of the ambient temperature T_A and power dissipation P_D ($T_J = T_A + P_D \times 55^\circ\text{C/W}$).

Note 2: XRP6657 has a build-in temperature protection circuitry to avoid damages from overload conditions.

ELECTRICAL SPECIFICATIONS

Specifications are for an Operating Junction Temperature of $T_A = 25^\circ\text{C}$ only; limits applying over the full Operating Ambient Temperature range are denoted by a “•”. Minimum and Maximum limits are guaranteed through test, design, or statistical correlation. Typical values represent the most likely parametric norm at $T_A = 25^\circ\text{C}$, and are provided for reference purposes only. Unless otherwise indicated, $V_{IN} = 5.0V$, $T_A = 25^\circ\text{C}$.

Parameter	Min.	Typ.	Max.	Units	Conditions
Feedback Current I_{VFB}			±100	nA	
Regulated Feedback Voltage V_{FB}	0.588	0.600	0.612	V	$T_A = 25^\circ\text{C}$
	0.585	0.600	0.615		• $-40^\circ\text{C} \leq T_A \leq 85^\circ\text{C}$
Reference Voltage Line Regulation ΔV_{FB}^3			0.4	%/V	• $V_{IN} = 2.5V$ to 5.5V
Output Voltage Accuracy $\Delta V_{OUT}\%$	-2.5		2.5	%	•
Output Over-Voltage Lockout ΔV_{OVL}	20	50	80	mV	$\Delta V_{OVL} = V_{OVL} - V_{FB}$
Output Voltage Line Regulation ΔV_{OUT}^4			0.4	%/V	• $V_{IN} = 2.5V$ to 5.5V
Peak Inductor Current I_{PK}		2.4		A	$V_{IN}=3V$, $V_{FB}=0.5V$ or $V_{OUT}=90\%$, duty cycle<35%
Output Voltage Load Regulation $V_{LOADREG}$		0.2		%/A	$I_{OUT}=10mA$ to 1.5A
Quiescent Current I_{Q^2}		240	340	µA	$V_{FB}=0.5V$ or $V_{OUT}=90\%$
Shutdown Current $I_{SHUTDOWN}$		0.1	1	µA	$V_{EN}=0V$, $V_{IN}=4.2V$
Oscillator Frequency f_{OSC}	1.04	1.3	1.56	MHz	• $V_{FB}=0.6V$ or $V_{OUT}=100\%$
Minimum Duty Cycle D_{MIN}		20		%	
RDS(ON) of PMOS R_{PFET}		0.18		Ω	$I_{SW}=750mA$
RDS(ON) of NMOS R_{NFET}		0.16		Ω	$I_{SW}=-750mA$
SW Leakage I_{LSW}			±1	µA	$V_{EN}=0V$, $V_{SW}=0V$ or 5V, $V_{IN}=5V$
Enable Threshold V_{EN}			1.2	V	•
Shutdown Threshold V_{EN}	0.4			V	•
EN Leakage Current I_{EN}			±1	µA	•

Note 1: The Switch Current Limit is related to the Duty Cycle. Please refer to figure 29 for details.

Note 2: Dynamic quiescent current is higher due to the gate charge being delivered at the switching frequency.

Note 3: Reference Voltage Line Regulations is defined as $\Delta V_{FB} = \frac{V_{FB2} - V_{FB1}}{V_{FB1}} \times 100$

1.5A 1.3MHz Synchronous Step Down Converter

Note 4: Output Voltage Line Regulation is defined as $\Delta V_{OUT} = \frac{V_{OUT2} - V_{OUT1}}{V_{IN2} - V_{IN1}} \times 100$

BLOCK DIAGRAM

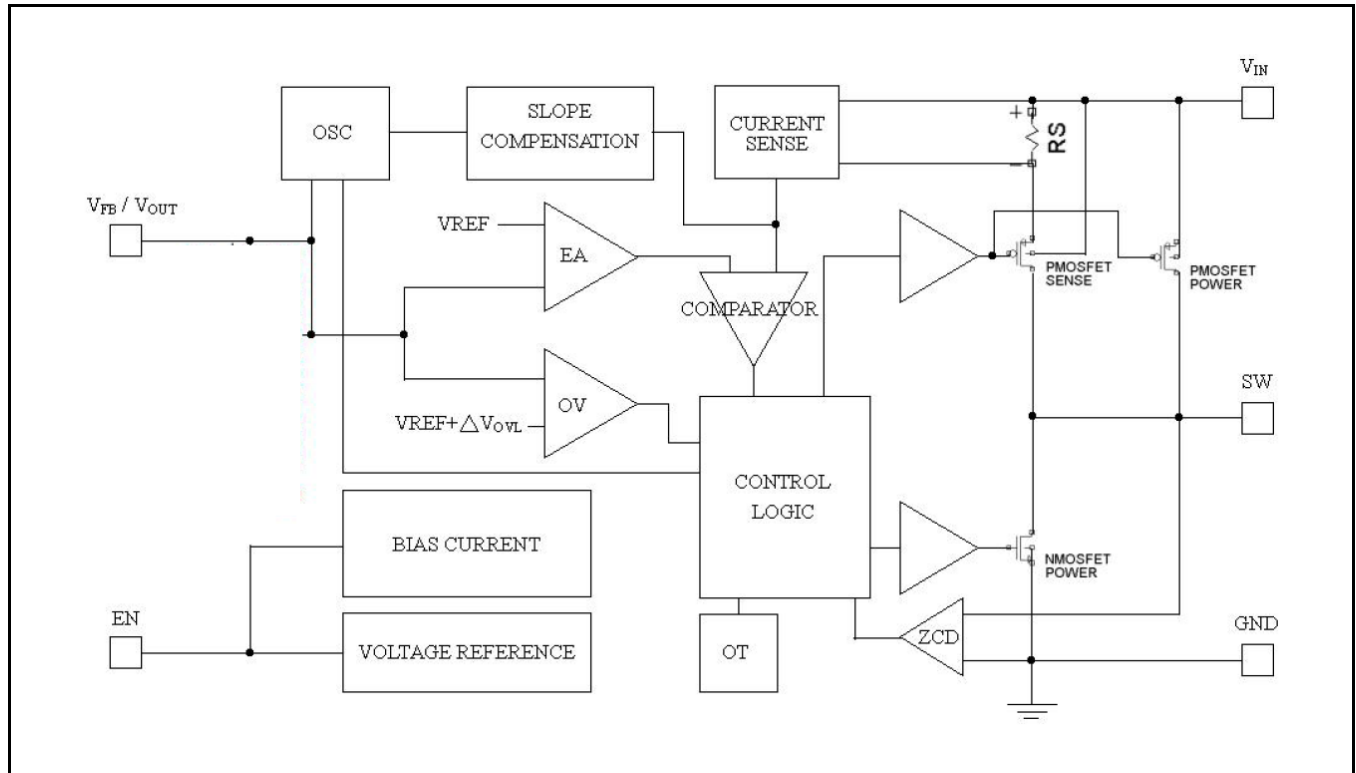

Fig. 2: XRP6657 Block Diagram

PIN ASSIGNMENT

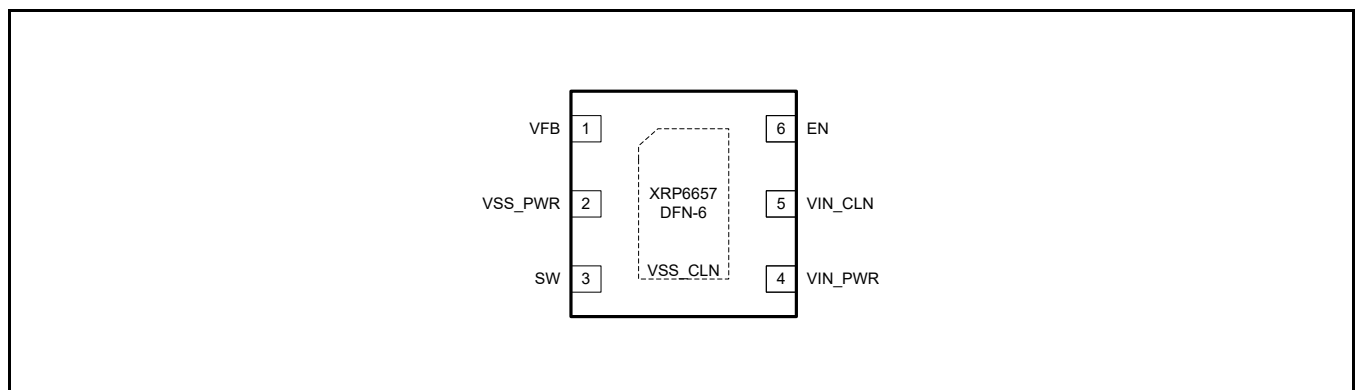

Fig. 3: XRP6657 Pin Assignment (Top View)

PIN DESCRIPTION

Name	Pin Number	Description
VFB	1	Feedback Pin. Receives the feedback voltage from an external resistive divider across the output.
VSS_PWR	2	Power Ground Pin.
SW	3	Switching node. Must be connected to inductor. This pin connects to the drains of the internal main and synchronous power MOSFET switches.
VIN_PWR	4	Power Input Pin. Must be closely decoupled to ground pin with a 4.7 μ F or greater capacitor.
VIN_CLN	5	Analog Input Pin. Must be closely decoupled to ground pin with a 4.7 μ F or greater capacitor.
EN	6	Enable Pin. >1.2V: Enables the XRP6657 <0.4V: Disables the XRP6657 Do not leave this pin floating and enable the device once Vin is in the operating range.
VSS_CLN	Exposed Pad	Analog Ground Pin.

ORDERING INFORMATION⁽¹⁾

Part Number	Temperature Range	Package	Packing Method	Lead Free ⁽²⁾	Note 1
XRP6657IHBTR-F	-40°C ≤ T _J ≤ +125°C	Thin DFN-6L	Tape and Reel	Yes	Adjustable output voltage
XRP6657EVB	XRP6657 Evaluation Board				

Notes:

1. Refer to www.maxlinear.com/XRP6657 for most up-to-date Ordering Information.
2. Visit www.maxlinear.com for additional information on Environmental Rating.

1.5A 1.3MHz Synchronous Step Down Converter

TYPICAL PERFORMANCE CHARACTERISTICS

All data taken at $V_{IN} = 2.7V$ to $5.5V$, $T_J = T_A = 25^\circ C$, unless otherwise specified - Schematic and BOM from Application Information section of this datasheet.

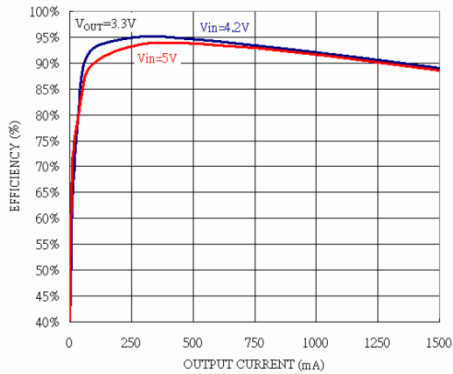

Fig. 4: Efficiency vs Output Current
 $V_{OUT}=3.3V$

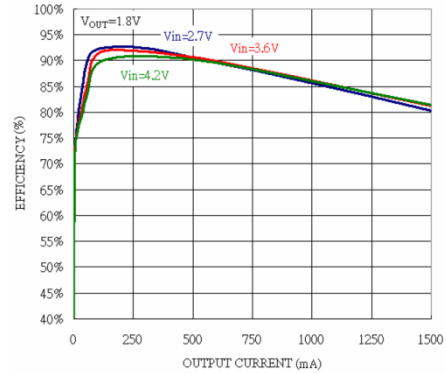

Fig. 5: Efficiency vs Output Current
 $V_{OUT}=1.8V$

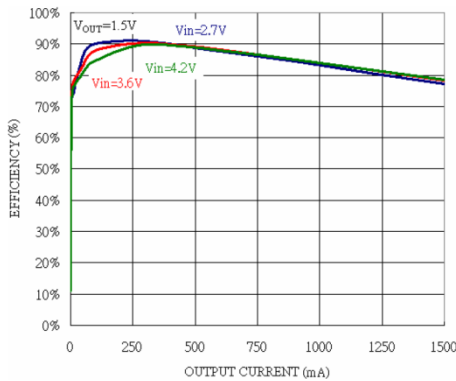

Fig. 6: Efficiency vs Output Current
 $V_{OUT}=1.5V$

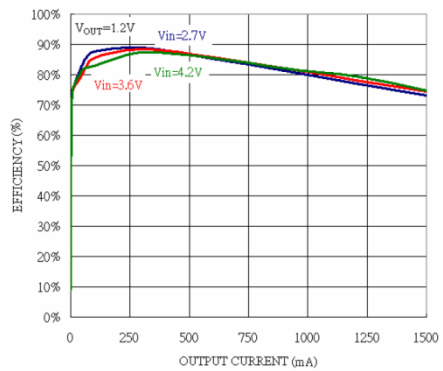

Fig. 7: Efficiency vs Output Current
 $V_{OUT}=1.2V$

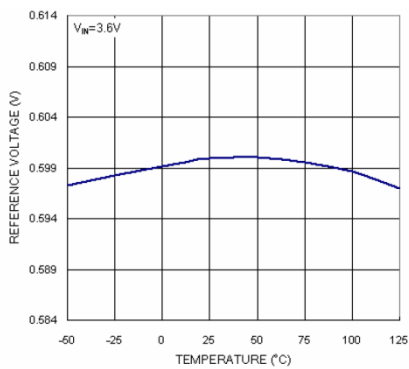

Fig. 8: Reference Voltage vs Temperature

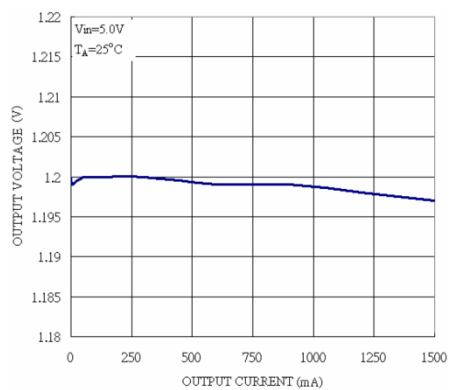

Fig. 9: Output Voltage vs Load Current

1.5A 1.3MHz Synchronous Step Down Converter

 Fig. 10: PMOS $R_{DS(ON)}$ vs Temperature

 Fig. 11: NMOS $R_{DS(ON)}$ vs Temperature

 Fig. 12: PMOS $R_{DS(ON)}$ vs Supply Voltage

 Fig. 13: NMOS $R_{DS(ON)}$ vs Temperature

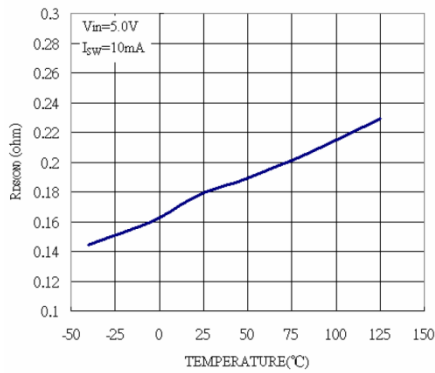
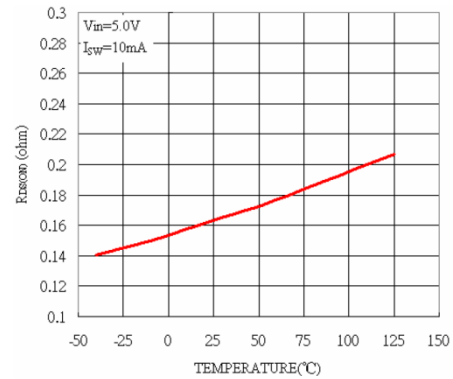
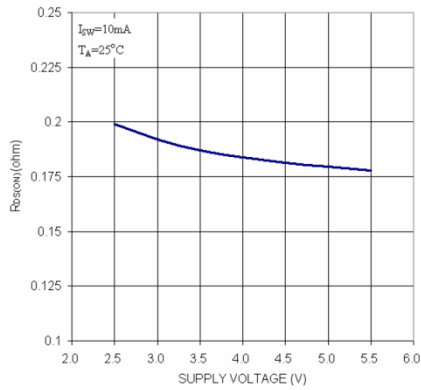
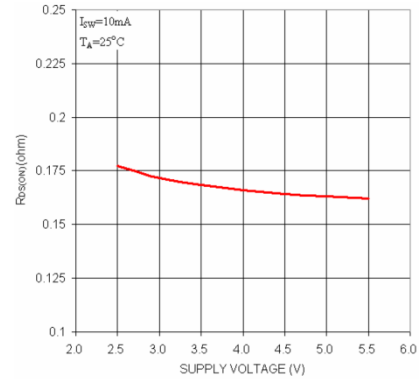
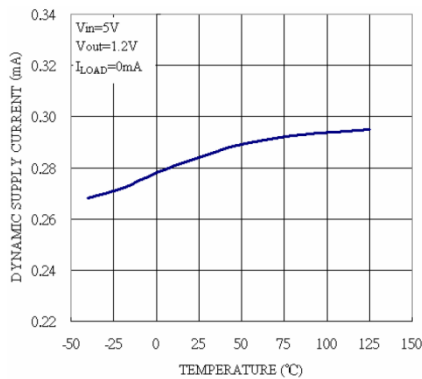
Fig. 14: Dynamic Supply Current vs Temperature

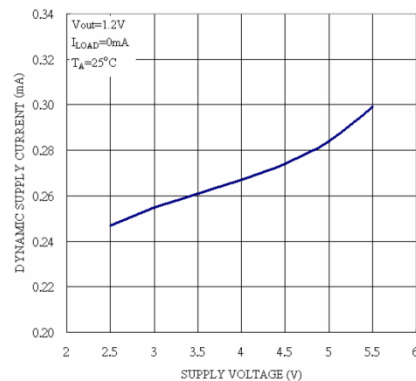

Fig. 15: Dynamic Supply Current vs Supply Voltage

1.5A 1.3MHz Synchronous Step Down Converter

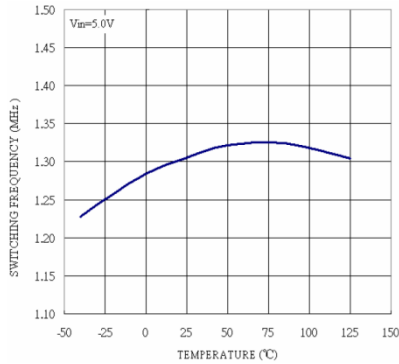

Fig. 16: Switching Frequency vs Temperature

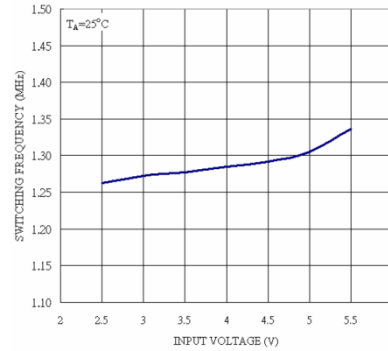

Fig. 17: Switching Frequency vs Supply Voltage

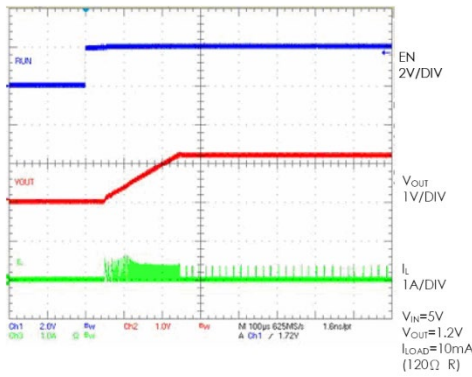

Fig. 18: Start-Up from Shutdown

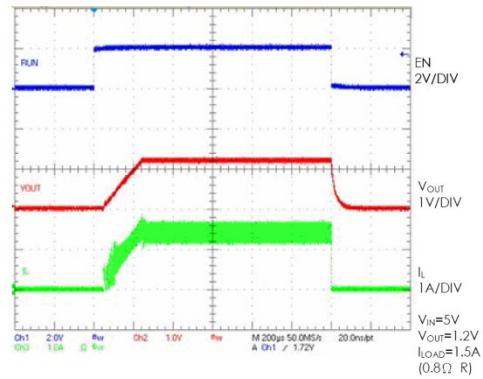

Fig. 19: Start-Up from Shutdown

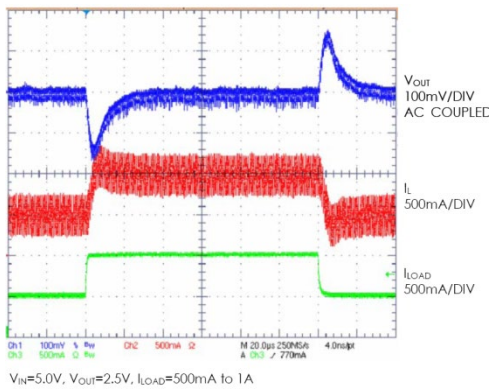

Fig. 20: Load Step

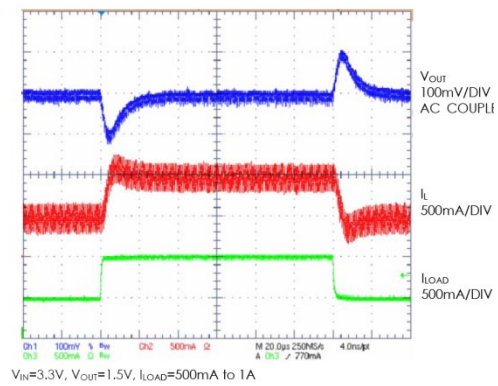

Fig. 21: Load Step

1.5A 1.3MHz Synchronous Step Down Converter

THEORY OF OPERATION

The typical application circuit is shown below.

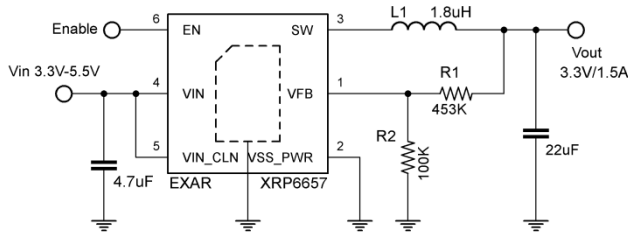

Fig. 22: Typical Application Circuit

INDUCTOR SELECTION

Inductor ripple current and core saturation are two factors considered to select the inductor value.

$$\text{Eq. 1: } \Delta I_L = \frac{1}{f \times L} V_{OUT} \left(1 - \frac{V_{OUT}}{V_{IN}}\right)$$

Equation 1 shows the inductor ripple current as a function of the frequency, inductance, V_{IN} and V_{OUT} . It is recommended to set the ripple current between 30% to 40% of the maximum load current. A low ESR inductor is preferred.

C_{IN} AND C_{OUT} SELECTION

A low ESR input capacitor can prevent large voltage transients at V_{IN} . The RMS current rating of the input capacitor is required to be larger than I_{RMS} calculated by:

$$\text{Eq. 2: } I_{RMS} \cong I_{OMAX} \times \frac{\sqrt{V_{OUT} \times (V_{IN} - V_{OUT})}}{V_{IN}}$$

The ESR rating of the capacitor is an important parameter to select C_{OUT} . The output ripple V_{OUT} is determined by:

$$\text{Eq. 3: } \Delta V_{OUT} \cong \Delta I_L \left(ESR + \frac{1}{8 \times f \times C_{OUT}}\right)$$

Higher values, lower cost ceramic capacitors are now available in smaller sizes. These capacitors have high ripple currents, high voltage ratings and low ESR that makes them ideal for switching regulator applications. As C_{OUT} does not affect the internal control loop stability, its value can be optimized to balance very low output ripple and circuit size. It is recommended to use an X5R or X7R rated capacitors which have the best temperature

and voltage characteristics of all the ceramics for a given value and size.

OUTPUT VOLTAGE

The adjustable output voltage is determined by:

$$\text{Eq. 4: } V_{OUT} = 0.6V \times \left(1 + \frac{R_1}{R_2}\right)$$

SHORT CIRCUIT BEHAVIOR

The XRP6657 has an over current and over temperature protection. The over current applies cycle by cycle and limits the P-driver FET current to maintain the inductor current within safe limits. The over temperature protection circuitry turns off the driver FETs when the junction temperature is too high. Normal Operations are restored when temperature drops below the safety threshold.

In the following example, the XRP6657 is used to convert a 5V input to a 1.2V output. Shorting V_{OUT} to ground triggers both the over current and over temperature protection circuits. The waveform is shown below.

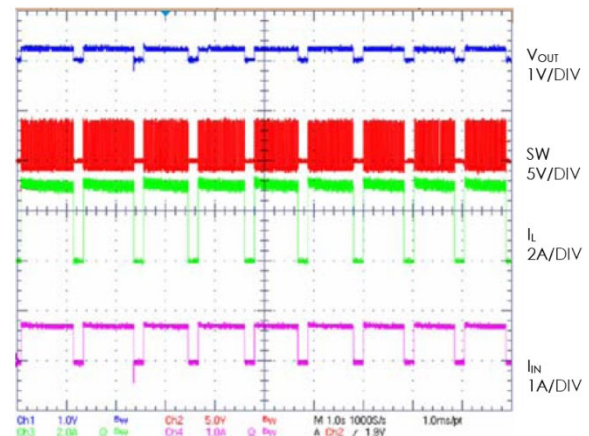

Fig. 23: Short Circuit Response

THERMAL CONSIDERATIONS

Although the XRP6657 has an on board over temperature circuitry, the total power dissipation it can support is based on the package thermal capabilities. The formula to ensure safe operation is given in note 1 under the operating ratings section.

1.5A 1.3MHz Synchronous Step Down Converter

To avoid exceeding the maximum junction temperature, thermal analysis is strongly suggested.

PCB LAYOUT

The following PCB layout guidelines should be taken into account to ensure proper operation and performance of the XRP6657:

- 1- The GND, SW and VIN traces should be kept short, direct and wide.
- 2- VFB pin must be connected directly to the feedback resistors. The resistor divider network must be connected in parallel to the C_{OUT} capacitor.
- 3- The input capacitor C_{IN} must be kept as close as possible to the VIN pin.
- 4- The SW and VFB nodes should be kept as separate as possible to minimize possible effects from the high frequency and voltage swings of the SW node.
- 5- The ground plates of C_{IN} and C_{OUT} should be kept as close as possible.
- 6- Connect all analog grounds to a common node and connect the common node to the power ground via an independent path.

SELF ENABLE APPLICATION

A self Enable function is easily implemented through the following arrangement.

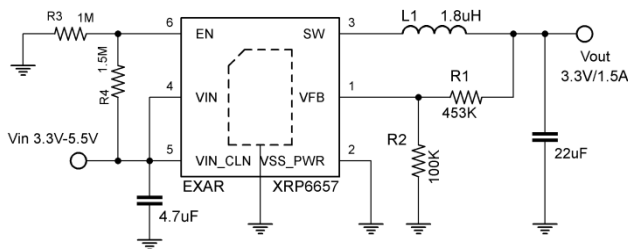

A resistor ratio $R_3/R_4=1/1.5$ is recommended.

OUTPUT VOLTAGE RIPPLE IN LDO MODE

The XRP6657 enters the LDO mode when input voltage is close to the selected output voltage. The transition from PWM mode to LDO mode is smooth. Figure 24 illustrates the amount of output voltage ripple for an output voltage of 3.3V providing 200mA.

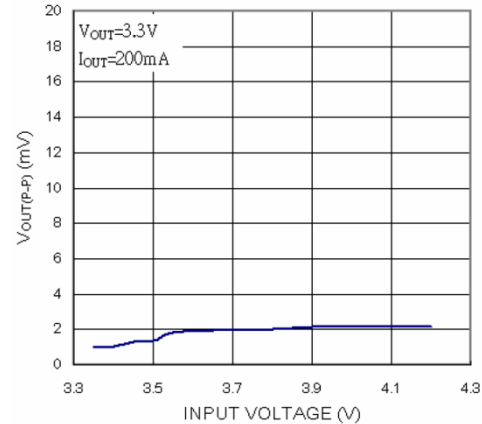

Fig. 24: Output Voltage Ripple in LDO mode

DESIGN EXAMPLE

In a single Lithium-Ion battery powered application, the V_{IN} range is about 2.7V to 4.2V. The desired output voltage is 1.8V.

The inductor value needed can be calculated using the following equation

$$L = \frac{1}{f \times \Delta I_L} V_{OUT} \left(1 - \frac{V_{OUT}}{V_{IN}} \right)$$

Substituting $V_{OUT}=1.8V$, $V_{IN}=4.2V$, $\Delta I_L=450mA$ to 600mA (30% to 40%) and $f=1.3MHz$ gives

$$L = 1.32\mu H \text{ to } 1.76\mu H$$

A 1.5 μH inductor can be chosen with this application. An inductor of greater value with less equivalent series resistance would provide better efficiency. The C_{IN} capacitor requires an RMS current rating of at least $I_{LOAD(MAX)}/2$ and low ESR. In most cases, a ceramic capacitor will satisfy this requirement. See recommended components section below

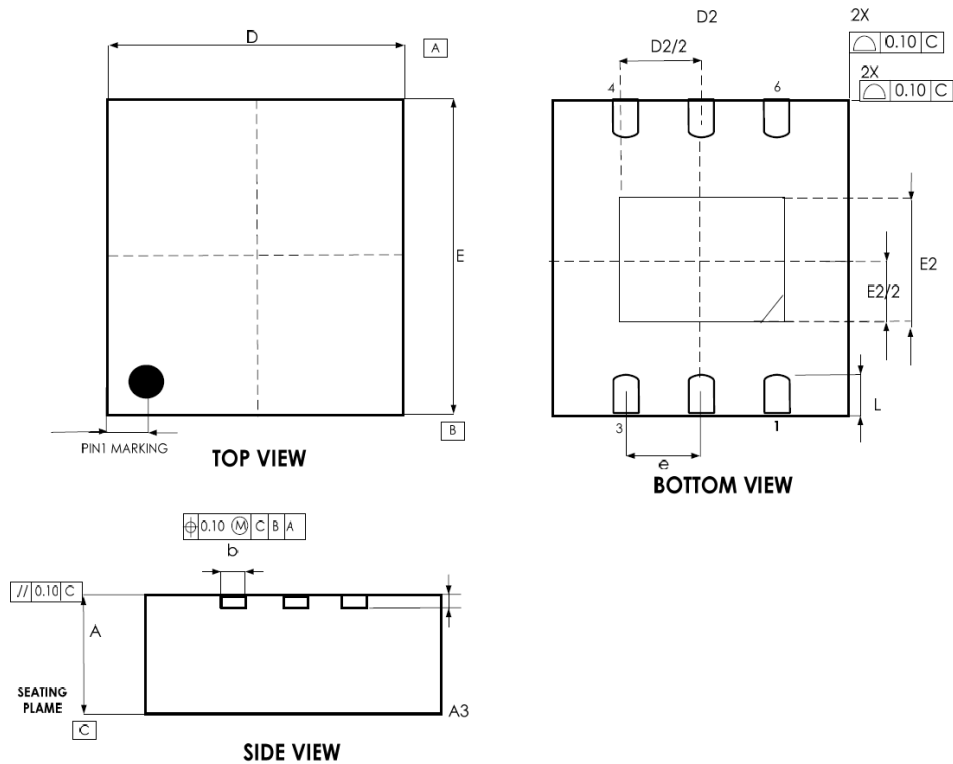
PACKAGE SPECIFICATION
THIN DFN-6L

SYMBOL	COMMON					
	DIMENSIONS MILLIMETER			DIMENSIONS INCH		
	MIN.	NOM.	MAX.	MIN.	NOM.	MAX.
A	0.70	0.75	0.80	0.028	0.030	0.031
A3	0.203 REF			0.008 REF		
b	0.25	0.30	0.35	0.010	0.012	0.014
D	3.00 BSC			0.118 BSC		
D2	2.20	2.30	2.35	0.087	0.091	0.093
E	3.00 BSC			0.118 BSC		
E2	1.40	1.50	1.55	0.055	0.059	0.061
e	0.95 BSC			0.037 BSC		
L	0.25	0.35	0.45	0.010	0.014	0.018

**1.5A 1.3MHz Synchronous Step Down Converter****REVISION**

Revision	Date	Description
1.0.0	07/14/2009	First release of data sheet
1.1.0	06/08/2010	Corrected Equation 2, V_{OUT} replaced by V_{IN}
1.2.0	02/15/2011	Corrected Output Voltage Accuracy from $\pm 3\%$ to $\pm 2.5\%$ Corrected Output Voltage Load Regulation unit from $\%/V$ to $\%/A$
1.3.0	03/14/2011	Added conditions to Reference Voltage Line Regulation in Electrical Characteristic Table Added Note 3 to Reference Voltage Line Regulation in Electrical Characteristic Table Added Note 4 to Output Voltage Line Regulation in Electrical Characteristic Table
1.4.0	02/07/2012	Updated Package Dimensions Corrected Applications Schematics values
1.5.0	1/17/2014	Removed Absolute Maximum Junction Temperature of $125^{\circ}C$; [ECN 1404-01] Added "Junction Temperature Range T_J $-40^{\circ}C$ to $125^{\circ}C$ " to operating ratings; In "Ordering Information" changed the temperature range to " $-40^{\circ}C \leq T_J \leq +125^{\circ}C$ "
1.5.1	11/01/2019	Updated to MaxLinear logo. Updated Ordering Information.



CORPORATE HEADQUARTERS:

5966 La Place Court

Suite 100

Carlsbad, CA 92008

Tel.: +1 (760) 692-0711

Fax: +1 (760) 444-8598

www.maxlinear.com

The content of this document is furnished for informational use only, is subject to change without notice, and should not be construed as a commitment by Maxlinear, Inc. Maxlinear, Inc. Assumes no responsibility or liability for any errors or inaccuracies that may appear in the informational content contained in this guide. Complying with all applicable copyright laws is the responsibility of the user. Without limiting the rights under copyright, no part of this document may be reproduced into, stored in, or introduced into a retrieval system, or transmitted in any form or by any means (electronic, mechanical, photocopying, recording, or otherwise), or for any purpose, without the express written permission of Maxlinear, Inc.

Maxlinear, Inc. Does not recommend the use of any of its products in life support applications where the failure or malfunction of the product can reasonably be expected to cause failure of the life support system or to significantly affect its safety or effectiveness. Products are not authorized for use in such applications unless Maxlinear, Inc. Receives, in writing, assurances to its satisfaction that: (a) the risk of injury or damage has been minimized; (b) the user assumes all such risks; (c) potential liability of Maxlinear, Inc. Is adequately protected under the circumstances.

Maxlinear, Inc. May have patents, patent applications, trademarks, copyrights, or other intellectual property rights covering subject matter in this document. Except as expressly provided in any written license agreement from Maxlinear, Inc., the furnishing of this document does not give you any license to these patents, trademarks, copyrights, or other intellectual property.

Maxlinear, the Maxlinear logo, and any Maxlinear trademarks, MxL, Full-Spectrum Capture, FSC, G.now, AirPHY and the Maxlinear logo are all on the products sold, are all trademarks of Maxlinear, Inc. or one of Maxlinear's subsidiaries in the U.S.A. and other countries. All rights reserved. Other company trademarks and product names appearing herein are the property of their respective owners.

© 2009 - 2019 Maxlinear, Inc. All rights reserved.