

G2-LXP2-RS2-P

~8.5° spot beam with light, black holder.
Assembly with location pins and installation
tape.

SPECIFICATION:

Dimensions	Ø 21.8 mm
Height	14.7 mm
Fastening	pin, tape
ROHS compliant	yes ⓘ



MATERIALS:

Component	Type	Material	Colour	Finish
LXP2-RS2	Single lens	PMMA		
LXP2-LT-HLD	Holder	PC	black	
HEIDI-TAPE	Tape	Acrylic foam	black	

ORDERING INFORMATION:

Component		Qty in box	MOQ	MPQ	Box weight (kg)
CA14505_G2-LXP2-RS2-P	Single lens	1680	336	112	8.1
» Box size: 480 x 280 x 300 mm					

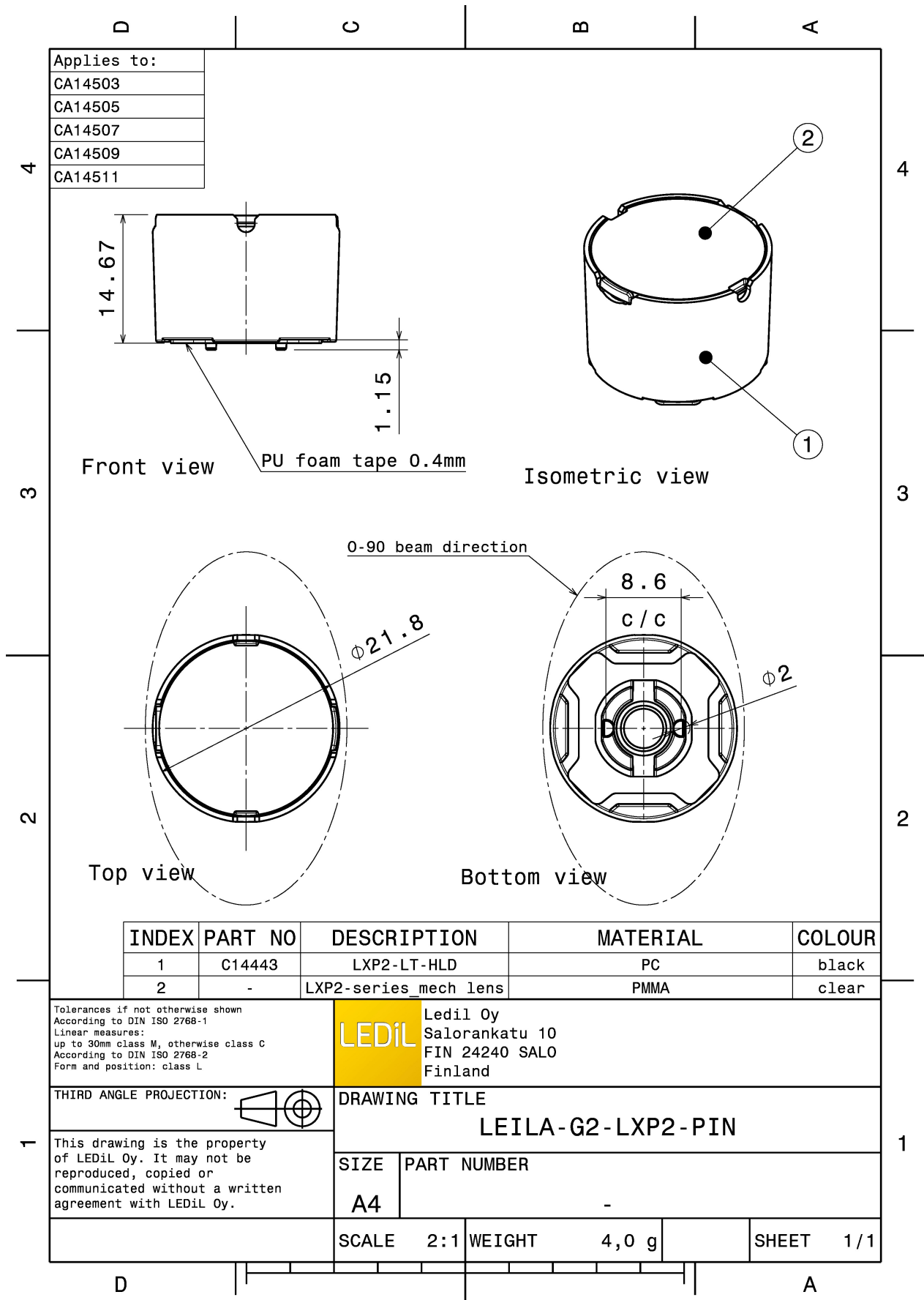

INDEX	PART NO	DESCRIPTION	MATERIAL	COLOUR
1	C14443	LXP2-LT-HLD	PC	black
2	-	LXP2-series_mech lens	PMMA	clear

Tolerances if not otherwise shown
According to DIN ISO 2768-1
Linear measures:
up to 30mm class M, otherwise class C
According to DIN ISO 2768-2
Form and position: class L

LEDiL Ledil Oy
Salorankatu 10
FIN 24240 SALO
Finland

THIRD ANGLE PROJECTION:

DRAWING TITLE
LEILA-G2-LXP2-PIN



This drawing is the property of LEDiL Oy. It may not be reproduced, copied or communicated without a written agreement with LEDiL Oy.

SIZE	PART NUMBER
A4	-

SCALE	2:1	WEIGHT	4,0 g	SHEET	1/1
-------	-----	--------	-------	-------	-----

See also our general installation guide: www.ledil.com/installation_guide

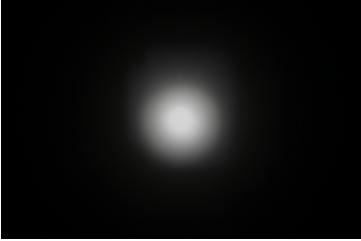
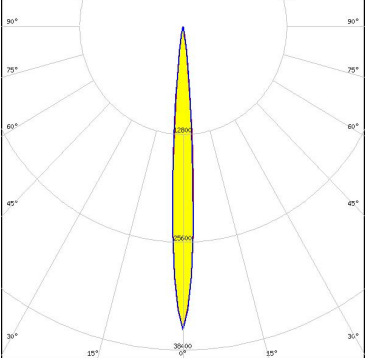
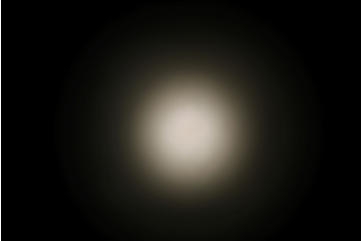
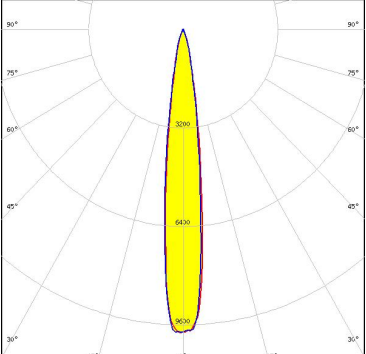
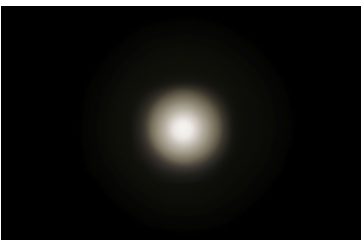
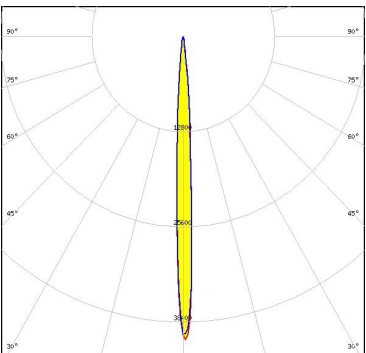
OPTICAL RESULTS (MEASURED):

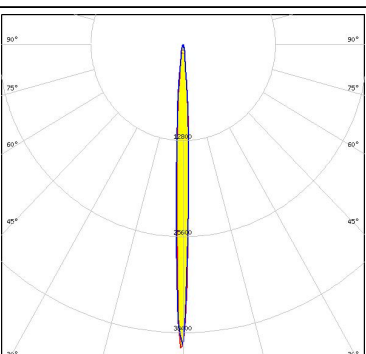
<p>CREE ⇄ LED</p> <p>LED XP-E FWHM / FWTM 7.0° / 15.0° Efficiency 88 % Peak intensity 34.7 cd/lm LEDs/each optic 1 Light colour White Required components:</p>		
<p>CREE ⇄ LED</p> <p>LED XP-L HD FWHM / FWTM 14.0° / 29.0° Efficiency 90 % Peak intensity 9.9 cd/lm LEDs/each optic 1 Light colour White Required components:</p>		
<p>CREE ⇄ LED</p> <p>LED XQ-E HD FWHM / FWTM 5.0° / 13.0° Efficiency 89 % Peak intensity 42 cd/lm LEDs/each optic 1 Light colour White Required components:</p>		
<p>CREE ⇄ LED</p> <p>LED XQ-E HI FWHM / FWTM 5.0° / 13.0° Efficiency 88 % Peak intensity 40.4 cd/lm LEDs/each optic 1 Light colour White Required components:</p>		

OPTICAL RESULTS (MEASURED):

LUMILEDS

LED LUXEON Rebel ES
 FWHM / FWTM 9.0° / 20.0°
 Efficiency 90 %
 Peak intensity 17.8 cd/lm
 LEDs/each optic 1
 Light colour White
 Required components:

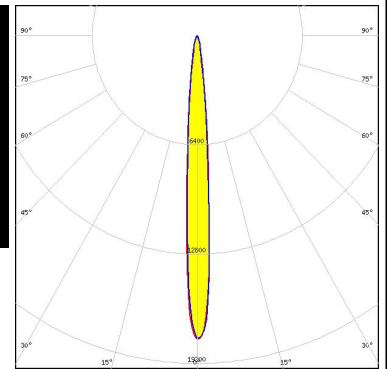
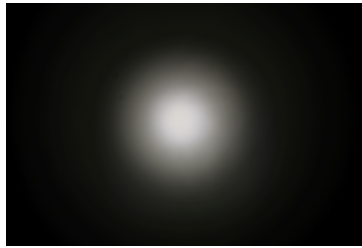

LUMILEDS

LED LUXEON V
 FWHM / FWTM 14.0° / 32.0°
 Efficiency 89 %
 Peak intensity 8.4 cd/lm
 LEDs/each optic 1
 Light colour White
 Required components:

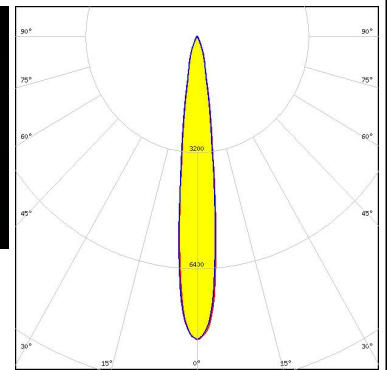
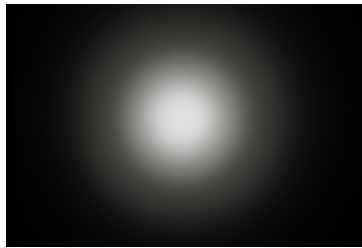

LUMILEDS

LED LUXEON V2
 FWHM / FWTM 9.0° / 22.0°
 Efficiency 90 %
 Peak intensity 15.7 cd/lm
 LEDs/each optic 1
 Light colour White
 Required components:

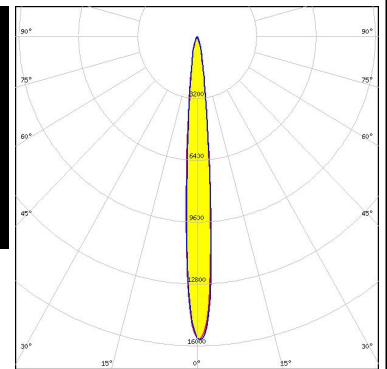
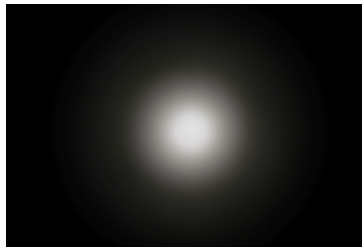

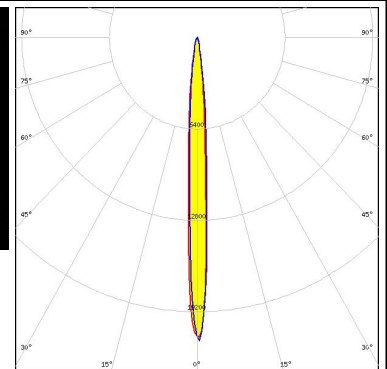

NICHIA

LED NCSxx19A
 FWHM / FWTM 6.8° / 18.0°
 Efficiency 89 %
 Peak intensity 21.3 cd/lm
 LEDs/each optic 1
 Light colour White
 Required components:

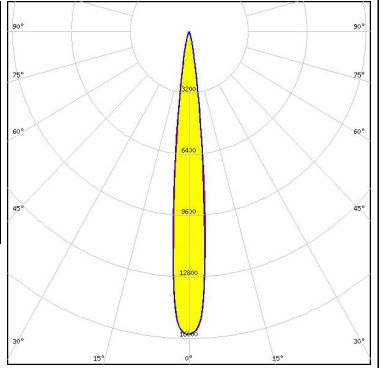

OPTICAL RESULTS (MEASURED):

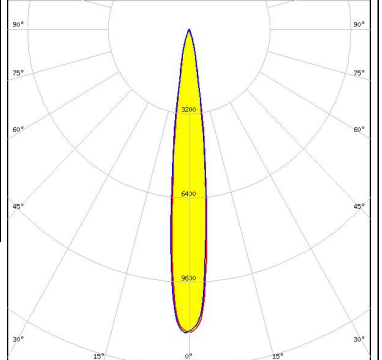
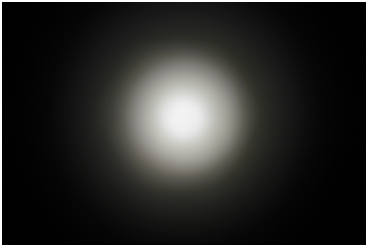
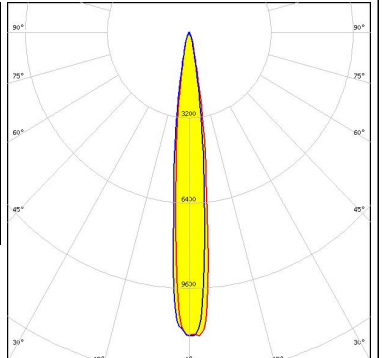
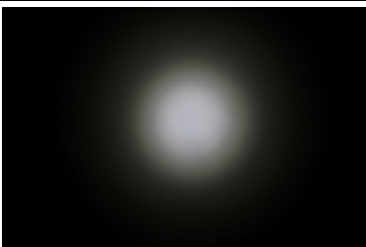
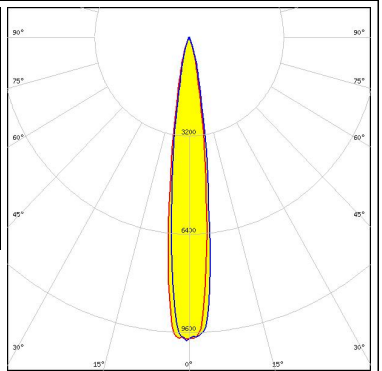
<p>NICHIA</p> <p>LED NVSW219D FWHM / FWTM 12.0° / 22.0° Efficiency 93 % Peak intensity 16 cd/lm LEDs/each optic 1 Light colour White Required components:</p>		
<p>NICHIA</p> <p>LED NVSW319B FWHM / FWTM 13.0° / 27.0° Efficiency 93 % Peak intensity 11.5 cd/lm LEDs/each optic 1 Light colour White Required components:</p>		
<p>NICHIA</p> <p>LED NVSW3x9A FWHM / FWTM 12.0° / 25.0° Efficiency 89 % Peak intensity 11.4 cd/lm LEDs/each optic 1 Light colour White Required components:</p>		
<p>NICHIA</p> <p>LED NVSW519A FWHM / FWTM 14.0° / 30.0° Efficiency 92 % Peak intensity 9.9 cd/lm LEDs/each optic 1 Light colour White Required components:</p>		

OPTICAL RESULTS (MEASURED):

OSRAM

Opto Semiconductors

LED OSLON Square CSSRM2/CSSRM3
 FWHM / FWTM 8.6° / 19.0°
 Efficiency 92 %
 Peak intensity 20.9 cd/lm
 LEDs/each optic 1
 Light colour White
 Required components:

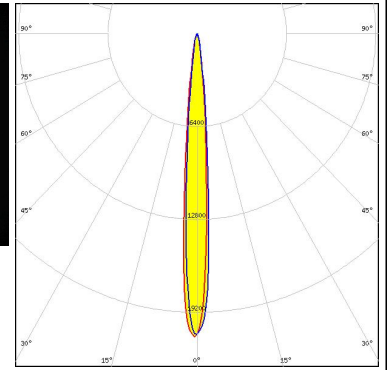

OSRAM

Opto Semiconductors

LED OSLON SSL 150
 FWHM / FWTM 5.0° / 13.0°
 Efficiency 90 %
 Peak intensity 41.9 cd/lm
 LEDs/each optic 1
 Light colour White
 Required components:

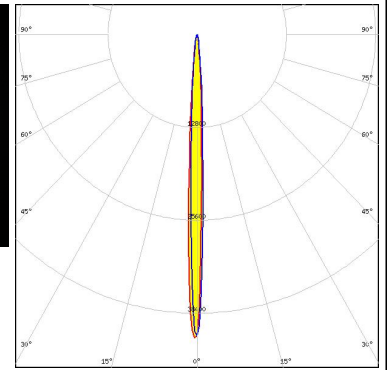

OSRAM

Opto Semiconductors

LED OSLON SSL 80
 FWHM / FWTM 5.0° / 14.0°
 Efficiency 91 %
 Peak intensity 37.1 cd/lm
 LEDs/each optic 1
 Light colour White
 Required components:

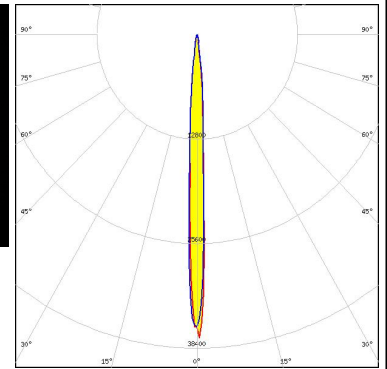



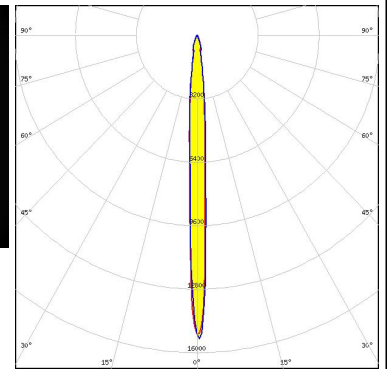
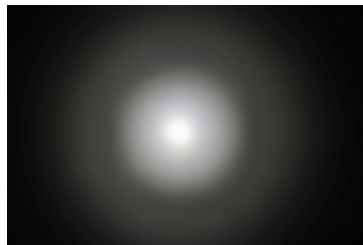

SAMSUNG

LED LH181A
 FWHM / FWTM 6.0° / 19.0°
 Efficiency 80 %
 Peak intensity 15.3 cd/lm
 LEDs/each optic 1
 Light colour White
 Required components:

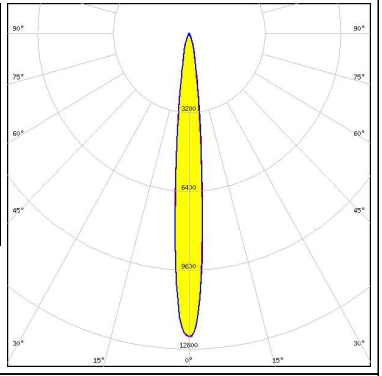

OPTICAL RESULTS (MEASURED):

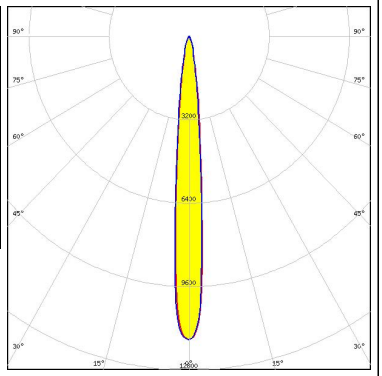
<p> SEOUL SEMICONDUCTOR</p> <p>LED Z5M3</p> <p>FWHM / FWTM 10.0° / 25.0°</p> <p>Efficiency 88 %</p> <p>Peak intensity 12.3 cd/lm</p> <p>LEDs/each optic 1</p> <p>Light colour White</p> <p>Required components:</p>		
<p> SEOUL SEMICONDUCTOR</p> <p>LED Z8Y22P</p> <p>FWHM / FWTM 10.0° / 24.0°</p> <p>Efficiency 84 %</p> <p>Peak intensity 11.6 cd/lm</p> <p>LEDs/each optic 1</p> <p>Light colour White</p> <p>Required components:</p>		

OPTICAL RESULTS (SIMULATED):



LED XP-E2
 FWHM / FWTM 8.0° / 16.0°
 Efficiency 93 %
 Peak intensity 38.5 cd/lm
 LEDs/each optic 1
 Light colour White
 Required components:

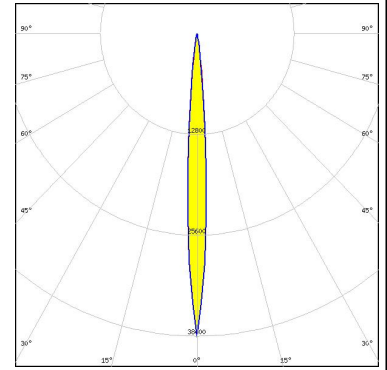

LED XP-G2
 FWHM / FWTM 10.0° / 20.0°
 Efficiency 94 %
 Peak intensity 22.2 cd/lm
 LEDs/each optic 1
 Light colour White
 Required components:

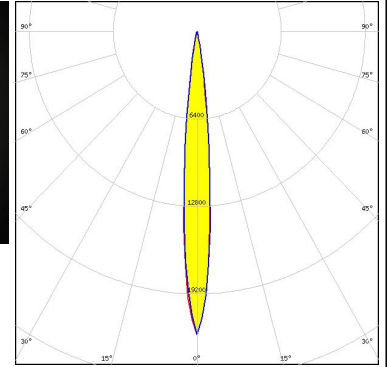

LED XP-G2 HE
 FWHM / FWTM 12.0° / 26.0°
 Efficiency 91 %
 Peak intensity 13.3 cd/lm
 LEDs/each optic 1
 Light colour White
 Required components:

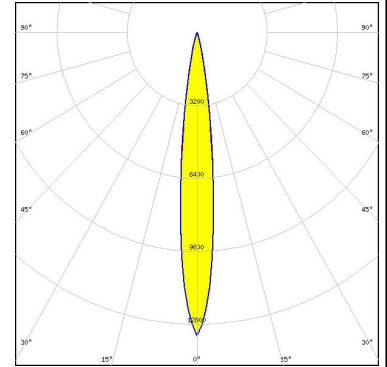

LED XP-G3
 FWHM / FWTM 12.0° / 25.0°
 Efficiency 91 %
 Peak intensity 13.5 cd/lm
 LEDs/each optic 1
 Light colour White
 Required components:

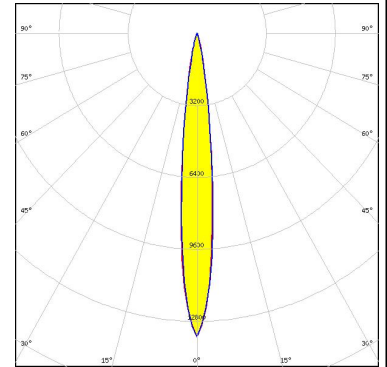

OPTICAL RESULTS (SIMULATED):



LED XP-P
 FWHM / FWTM 6.0° / 14.0°
 Efficiency 93 %
 Peak intensity 48.4 cd/lm
 LEDs/each optic 1
 Light colour White
 Required components:

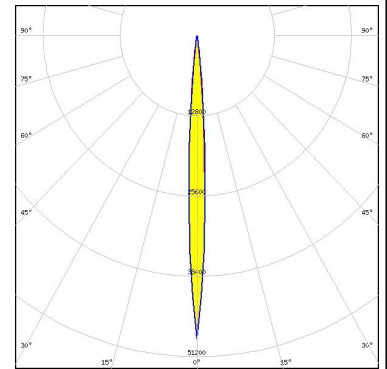

LED LUXEON CZ
 FWHM / FWTM 6.0° / 14.0°
 Efficiency 92 %
 Peak intensity 52.1 cd/lm
 LEDs/each optic 1
 Light colour Red
 Required components:

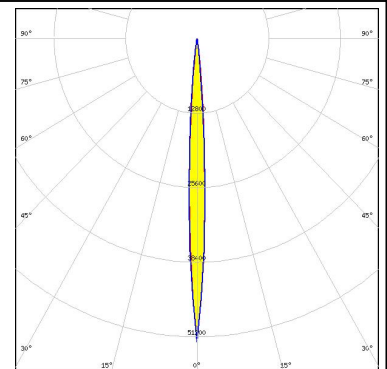

LED LUXEON HL1Z
 FWHM / FWTM 6.0° / 18.0°
 Efficiency 88 %
 Peak intensity 26 cd/lm
 LEDs/each optic 1
 Light colour White
 Required components:

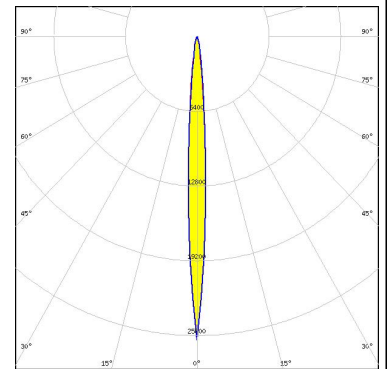

LED LUXEON HL2X
 FWHM / FWTM 14.0° / 26.0°
 Efficiency 93 %
 Peak intensity 12.6 cd/lm
 LEDs/each optic 1
 Light colour White
 Required components:

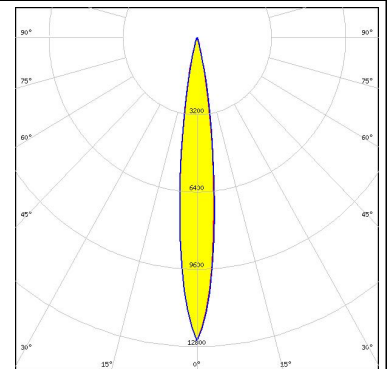

OPTICAL RESULTS (SIMULATED):

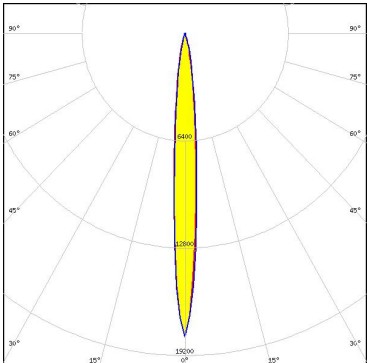
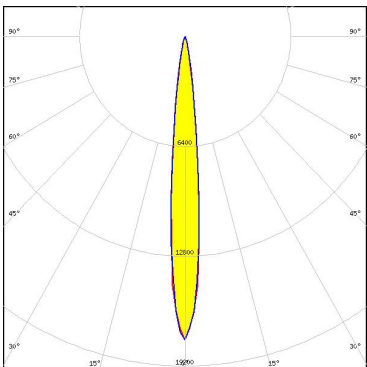
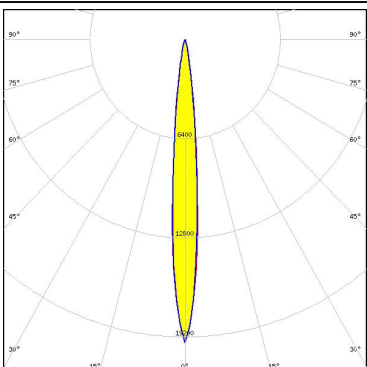
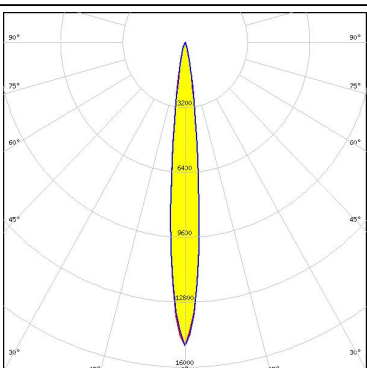
<p>LUMILEDS</p> <p>LED: LUXEON IR Domed 60 FWHM / FWTM: 9.0° / 23.0° Efficiency: 93 % LEDs/each optic: 1 Light colour: IR Required components:</p>	
<p>LUMILEDS</p> <p>LED: LUXEON T FWHM / FWTM: 11.0° / 22.0° Efficiency: 93 % Peak intensity: 17.7 cd/lm LEDs/each optic: 1 Light colour: White Required components:</p>	
<p>LUMILEDS</p> <p>LED: LUXEON TX FWHM / FWTM: 9.7° / 21.0° Efficiency: 91 % Peak intensity: 19.6 cd/lm LEDs/each optic: 1 Light colour: White Required components:</p>	
<p>NICHIA</p> <p>LED: NVSxx19B/NVSxx19C FWHM / FWTM: 11.0° / 23.0° Efficiency: 88 % Peak intensity: 15.5 cd/lm LEDs/each optic: 1 Light colour: White Required components:</p>	

OPTICAL RESULTS (SIMULATED):

<p>NICHIA</p> <p>LED NVSxx19B/NVSxx19C FWHM / FWTM 12.0° / 24.0° Efficiency 91 % Peak intensity 16.1 cd/lm LEDs/each optic 1 Light colour White Required components:</p>	
<p>OSRAM Opto Semiconductors</p> <p>LED OSCONIQ P 3030 FWHM / FWTM 8.0° / 18.0° Efficiency 92 % Peak intensity 27.6 cd/lm LEDs/each optic 1 Light colour Blue Required components:</p>	
<p>OSRAM Opto Semiconductors</p> <p>LED OSCONIQ P 3737 Flat FWHM / FWTM 10.0° / 24.0° Efficiency 93 % Peak intensity 15.9 cd/lm LEDs/each optic 1 Light colour White Required components:</p>	
<p>OSRAM Opto Semiconductors</p> <p>LED OSLOK Black Flat FWHM / FWTM 8.0° / 16.0° Efficiency 90 % Peak intensity 26.5 cd/lm LEDs/each optic 1 Light colour White Required components:</p>	

OPTICAL RESULTS (SIMULATED):

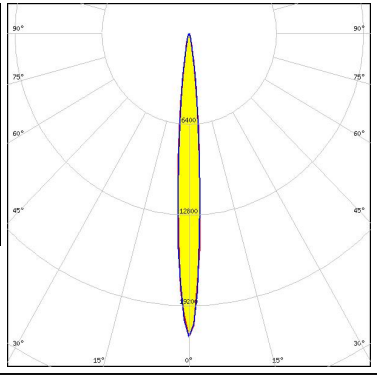
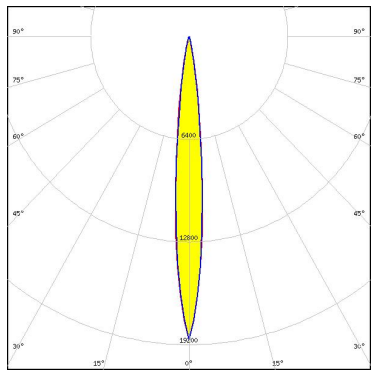
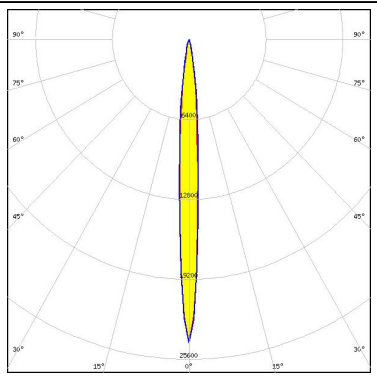
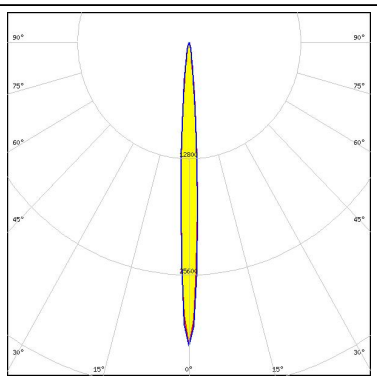
<p>OSRAM Opto Semiconductors</p> <p>LED: OSLOM Square Flat</p> <p>FWHM / FWTM: 8.7° / 19.0°</p> <p>Efficiency: 91 %</p> <p>Peak intensity: 21.4 cd/lm</p> <p>LEDs/each optic: 1</p> <p>Light colour: White</p> <p>Required components:</p>		
<p>OSRAM Opto Semiconductors</p> <p>LED: OSLOM Square PC</p> <p>FWHM / FWTM: 11.0° / 22.0°</p> <p>Efficiency: 94 %</p> <p>Peak intensity: 18.9 cd/lm</p> <p>LEDs/each optic: 1</p> <p>Light colour: White</p> <p>Required components:</p>		
<p>OSRAM Opto Semiconductors</p> <p>LED: SFH 4715AS</p> <p>FWHM / FWTM: 7.0° / 19.0°</p> <p>Efficiency: 92 %</p> <p>Peak intensity: 24.3 cd/lm</p> <p>LEDs/each optic: 1</p> <p>Light colour: IR</p> <p>Required components:</p>		
<p>OSRAM Opto Semiconductors</p> <p>LED: SFH 4716AS</p> <p>FWHM / FWTM: 6.5° / 15.0°</p> <p>Efficiency: 92 %</p> <p>Peak intensity: 33.4 cd/lm</p> <p>LEDs/each optic: 1</p> <p>Light colour: IR</p> <p>Required components:</p>		

OPTICAL RESULTS (SIMULATED):

SAMSUNG

LED LH351A
 FWHM / FWTM 9.0° / 20.0°
 Efficiency 91 %
 Peak intensity 21.9 cd/lm
 LEDs/each optic 1
 Light colour White
 Required components:

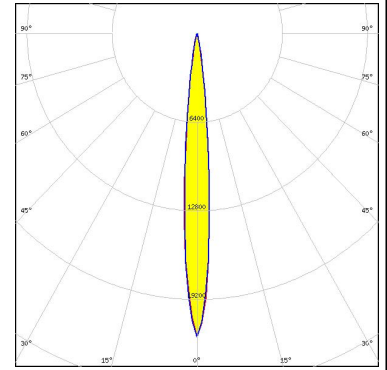

SAMSUNG

LED LH351B
 FWHM / FWTM 10.0° / 23.0°
 Efficiency 92 %
 Peak intensity 17.4 cd/lm
 LEDs/each optic 1
 Light colour White
 Required components:

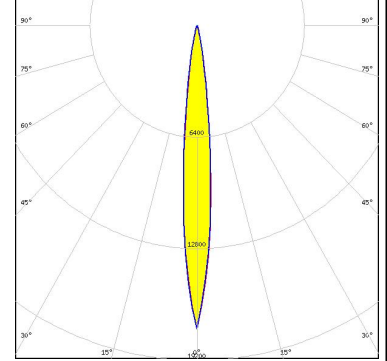

SAMSUNG

LED LH351D
 FWHM / FWTM 16.0° / 30.0°
 Efficiency 91 %
 Peak intensity 8.9 cd/lm
 LEDs/each optic 1
 Light colour White
 Required components:

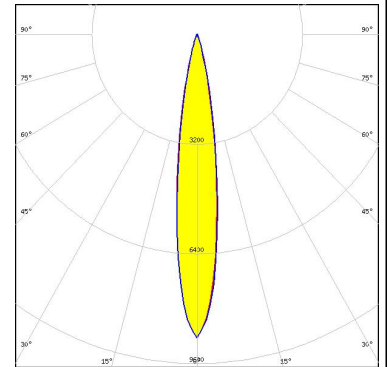

SAMSUNG

LED LH351Z
 FWHM / FWTM 9.0° / 19.0°
 Efficiency 93 %
 LEDs/each optic 1
 Light colour White
 Required components:

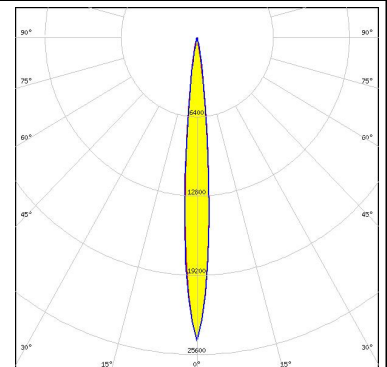

OPTICAL RESULTS (SIMULATED):

<p>SEOUL SEMICONDUCTOR</p> <p>LED: Z5M1/Z5M2</p> <p>FWHM / FWTM: 10.0° / 20.0°</p> <p>Efficiency: 93 %</p> <p>Peak intensity: 19.9 cd/lm</p> <p>LEDs/each optic: 1</p> <p>Light colour: White</p> <p>Required components:</p>	
<p>SEOUL SEMICONDUCTOR</p> <p>LED: Z5M4</p> <p>FWHM / FWTM: 12.0° / 26.0°</p> <p>Efficiency: 94 %</p> <p>Peak intensity: 12.9 cd/lm</p> <p>LEDs/each optic: 1</p> <p>Light colour: White</p> <p>Required components:</p>	
<p>SEOUL SEMICONDUCTOR</p> <p>LED: Z5P</p> <p>FWHM / FWTM: 8.0° / 17.0°</p> <p>Efficiency: 92 %</p> <p>Peak intensity: 26.1 cd/lm</p> <p>LEDs/each optic: 1</p> <p>Light colour: White</p> <p>Required components:</p>	

GENERAL INFORMATION:

NOTE: The typical beam angle will be changed by different color, chip size and chip position tolerance. The typical total beam angle is the full angle measured where the luminous intensity is half of the peak value.

MATERIALS:

As part of our continuous research and improvement processes, and to ensure the best possible quality and availability of our products, LEDiL reserves the right to change material grades without notice.

PRODUCT DATA USER AGREEMENT AND DISCLAIMER:

The measured data in the provided downloadable LEDiL Product Datasheets and Mechanical 2D-Drawings is rounded and provided as reference for planning. LEDiL Oy's optical specifications have been verified by conducting performance testing of the products in accordance with the company's quality system. The reported data are averaged results of multiple measurements with typical variation. LEDiL Oy reserves the right to without prior notification make changes and improvements to its products.

LEDiL Oy assumes neither warranty, nor guarantee nor any other liability of any kind for the contents and correctness of the provided data. The provided data has been generated with highest diligence but the provided data may in reality not represent the complete possible variation range of all intrinsic parameters. Therefore, in certain cases a deviation from the provided data could occur.

LEDiL Oy reserves the right to undertake technical changes of its products without further notification which could lead to changes in the provided data. LEDiL Oy assumes no liability of any kind for the possible deviation from any provided data or any other damage resulting from the usage of the provided data.

The user agrees to this disclaimer and user agreement with the download or usage of the provided files.

LEDiL Oy

Joensuunkatu 13
FI-24240 SALO
Finland

LEDiL Inc.

228 West Page Street
Suite D
Sycamore IL 60178
USA

Ledil Optics Technology (Shenzhen) Co., Ltd.

405 , Block B
Casic Motor Building
Shenzhen 518057
P.R.CHINA

Local sales and technical support

[www.ledil.com/
where_to_buy](http://www.ledil.com/where_to_buy)

Shipping locations

Salo, Finland
Hong Kong, China

Distribution Partners

[www.ledil.com/
where_to_buy](http://www.ledil.com/where_to_buy)