

## LEILA-Y-M

~25° medium beam. 14.8 mm high assembly with holder, installation tape and pins.

### SPECIFICATION:

Dimensions	Ø 21.6 mm
Height	14.8 mm
ROHS compliant	yes ⓘ



### MATERIALS:

Component	Type	Material	Colour	Finish
LEILA-Y-M	Single lens	PMMA	clear	
LEILA-Y-HLD	Holder	PC	black	gloss
LEILA-Y-TAPE	Tape	Acrylic foam		

### ORDERING INFORMATION:

Component	Qty in box	MOQ	MPQ	Box weight (kg)
CA18091_LEILA-Y-M » Box size: 476 x 273 x 197 mm	1800	180	180	6.7

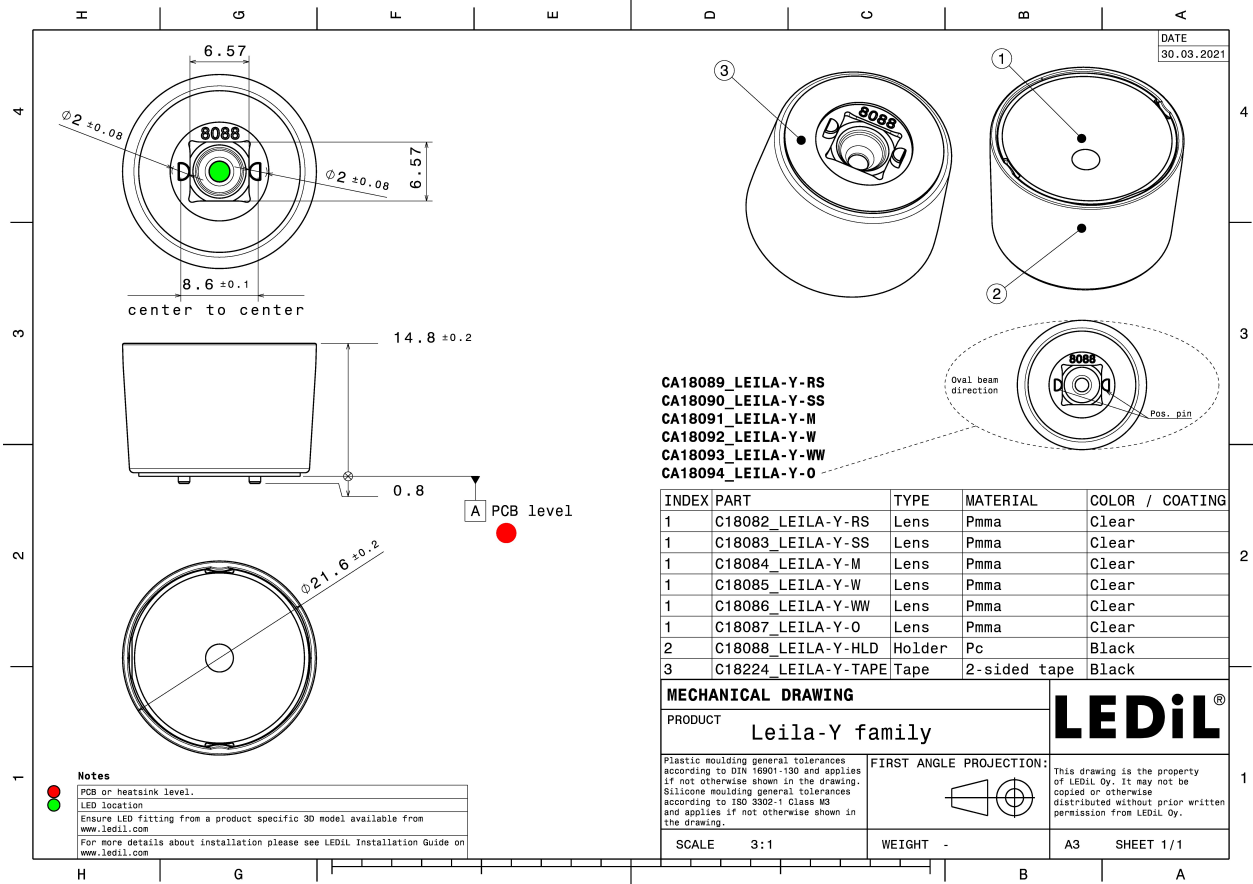

See also our general installation guide: [www.ledil.com/installation\\_guide](http://www.ledil.com/installation_guide)

#### OPTICAL RESULTS (MEASURED):

##### CREE LED

LED XHP35 HI  
 FWHM / FWTM 22.0° / 37.0°  
 Efficiency 83 %  
 Peak intensity 5.2 cd/lm  
 LEDs/each optic 1  
 Light colour White  
 Required components:

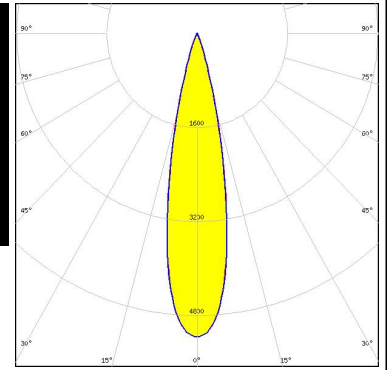

##### CREE LED

LED XP-G3  
 FWHM / FWTM 23.0° / 39.0°  
 Efficiency 78 %  
 Peak intensity 4.6 cd/lm  
 LEDs/each optic 1  
 Light colour White  
 Required components:

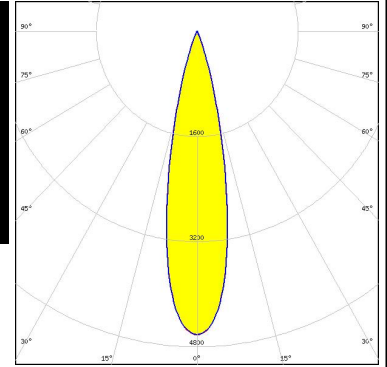

##### LUMILEDS

LED LUXEON 5050 Round LES  
 FWHM / FWTM 28.0° / 48.0°  
 Efficiency 77 %  
 Peak intensity 2.9 cd/lm  
 LEDs/each optic 1  
 Light colour White  
 Required components:

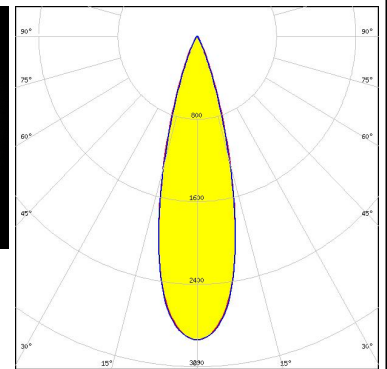
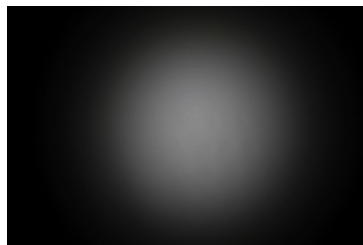

##### NICHIA

LED NVSW719AC  
 FWHM / FWTM 21.0° / 35.0°  
 Efficiency 85 %  
 Peak intensity 6.1 cd/lm  
 LEDs/each optic 1  
 Light colour White  
 Required components:

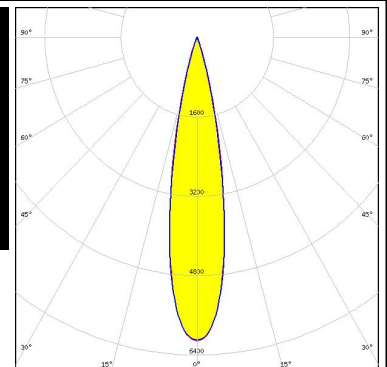
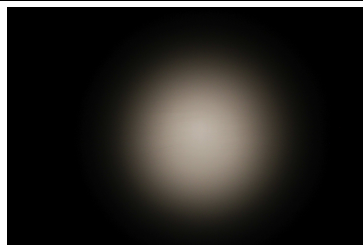

#### OPTICAL RESULTS (SIMULATED):



LED XM-L RGBW (XMLDCL HD)  
 FWHM / FWTM 32.0° / 48.0°  
 Efficiency 89 %  
 Peak intensity 3 cd/lm  
 LEDs/each optic 1  
 Light colour RGBW  
 Required components:

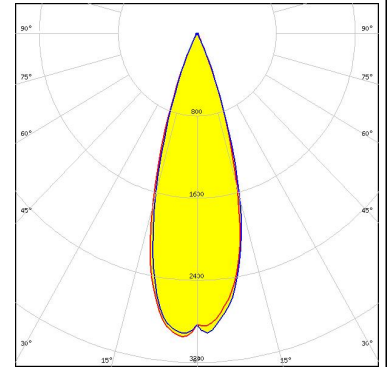

LED XM-L RGBW (XMLDCL HI)  
 FWHM / FWTM 23.0° / 40.0°  
 Efficiency 87 %  
 Peak intensity 4.8 cd/lm  
 LEDs/each optic 1  
 Light colour RGBW  
 Required components:

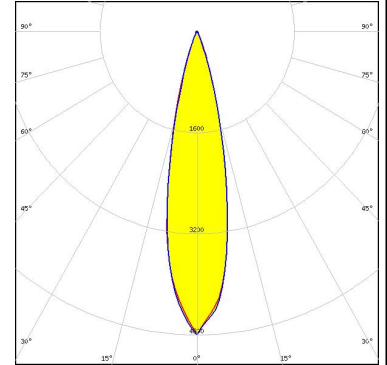



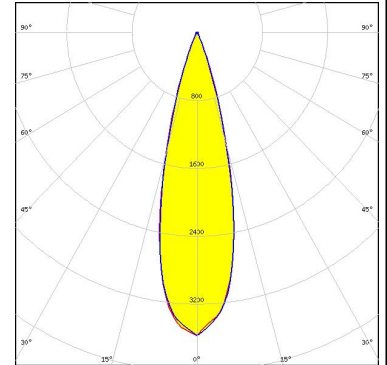

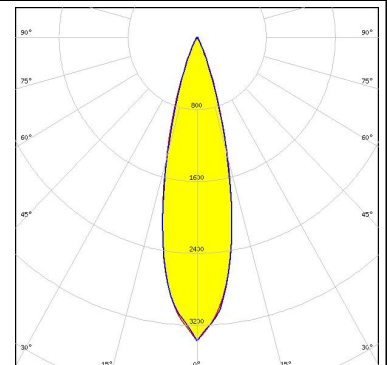

LED XM-L3  
 FWHM / FWTM 28.0° / 44.0°  
 Efficiency 83 %  
 Peak intensity 3.6 cd/lm  
 LEDs/each optic 1  
 Light colour White  
 Required components:

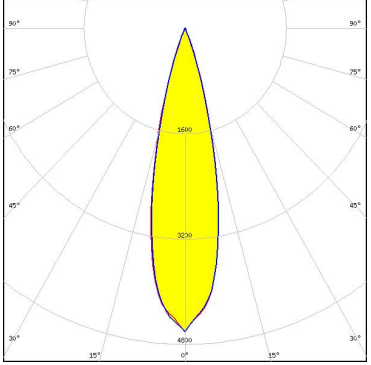

LED LUXEON 5050 Square LES  
 FWHM / FWTM 26.0° / 46.0°  
 Efficiency 80 %  
 Peak intensity 3.4 cd/lm  
 LEDs/each optic 1  
 Light colour White  
 Required components:

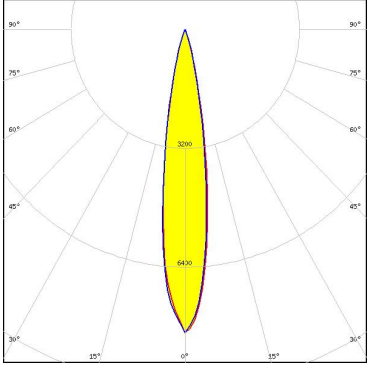

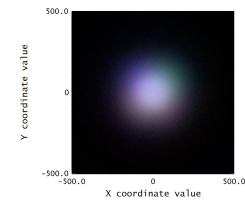
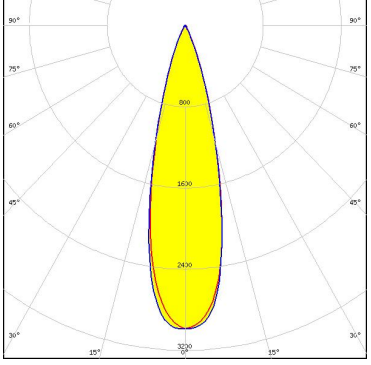
### OPTICAL RESULTS (SIMULATED):

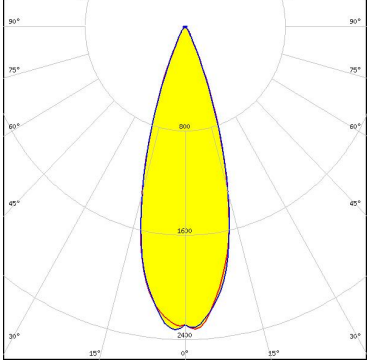
 <p>LED LUXEON HL2X FWHM / FWMT 25.0° / 40.0° Efficiency 88 % Peak intensity 4.6 cd/lm LEDs/each optic 1 Light colour White Required components:</p>		
 <p>LED LUXEON Z ES FWHM / FWMT 17.0° / 32.0° Efficiency 87 % Peak intensity 8.2 cd/lm LEDs/each optic 1 Light colour White Required components:</p>		
 <p>LED NCSxE17A FWHM / FWMT 27.0° / 46.0° Efficiency 73 % Peak intensity 3 cd/lm LEDs/each optic 4 Light colour RGB Required components:</p>	 <p>Detector Image: Illuminance</p> <p>Zemax Zemax OpticStudio 21.3 © 2021 Zemax Corporation, Kirkland, WA, USA. All rights reserved. Please refer to the Zemax File, Read Me's and License Agreement for more information. Configuration: 1 of 1</p>	
 <p>LED NV4x144A FWHM / FWMT 32.0° / 52.0° Efficiency 78 % Peak intensity 2.4 cd/lm LEDs/each optic 1 Light colour White Required components:</p>		

#### OPTICAL RESULTS (SIMULATED):

##### OSRAM

Opto Semiconductors

LED OSCONIQ P 3737 (3W version)  
 FWHM / FWTM 24.0° / 41.0°  
 Efficiency 85 %  
 Peak intensity 4.7 cd/lm  
 LEDs/each optic 1  
 Light colour White  
 Required components:

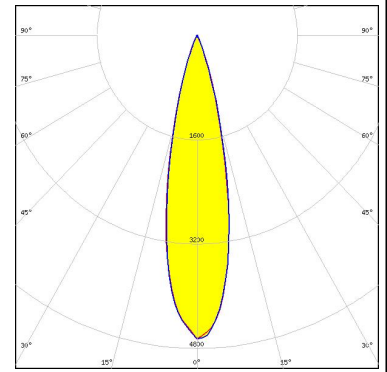

##### OSRAM

Opto Semiconductors

LED OSLO PURE 1010  
 FWHM / FWTM 20.0° / 38.0°  
 Efficiency 79 %  
 Peak intensity 5.2 cd/lm  
 LEDs/each optic 4  
 Light colour White  
 Required components:

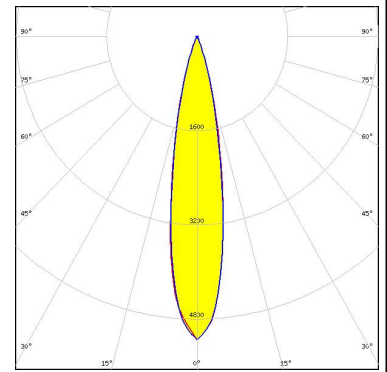

##### OSRAM

Opto Semiconductors

LED OSLO SSL 150  
 FWHM / FWTM 20.0° / 34.0°  
 Efficiency 88 %  
 LEDs/each optic 1  
 Light colour White  
 Required components:

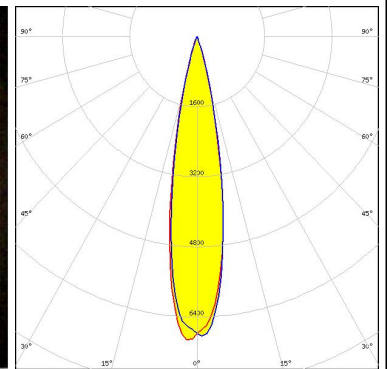

##### SAMSUNG

LED LH351B  
 FWHM / FWTM 24.0° / 40.0°  
 Efficiency 87 %  
 Peak intensity 4.8 cd/lm  
 LEDs/each optic 1  
 Light colour White  
 Required components:

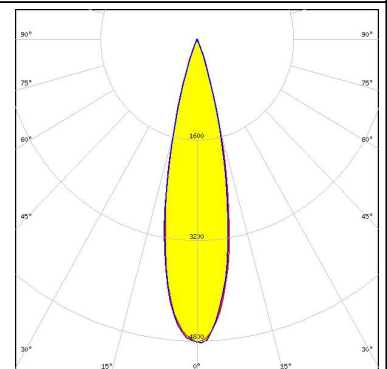

### OPTICAL RESULTS (SIMULATED):



### GENERAL INFORMATION:

NOTE: The typical beam angle will be changed by different color, chip size and chip position tolerance. The typical total beam angle is the full angle measured where the luminous intensity is half of the peak value.

### MATERIALS:

As part of our continuous research and improvement processes, and to ensure the best possible quality and availability of our products, LEDiL reserves the right to change material grades without notice.

### PRODUCT DATA USER AGREEMENT AND DISCLAIMER:

The measured data in the provided downloadable LEDiL Product Datasheets and Mechanical 2D-Drawings is rounded and provided as reference for planning. LEDiL Oy's optical specifications have been verified by conducting performance testing of the products in accordance with the company's quality system. The reported data are averaged results of multiple measurements with typical variation. LEDiL Oy reserves the right to without prior notification make changes and improvements to its products.

LEDiL Oy assumes neither warranty, nor guarantee nor any other liability of any kind for the contents and correctness of the provided data. The provided data has been generated with highest diligence but the provided data may in reality not represent the complete possible variation range of all intrinsic parameters. Therefore, in certain cases a deviation from the provided data could occur.

LEDiL Oy reserves the right to undertake technical changes of its products without further notification which could lead to changes in the provided data. LEDiL Oy assumes no liability of any kind for the possible deviation from any provided data or any other damage resulting from the usage of the provided data.

The user agrees to this disclaimer and user agreement with the download or usage of the provided files.

#### LEDiL Oy

Joensuunkatu 13  
FI-24240 SALO  
Finland

#### LEDiL Inc.

228 West Page Street  
Suite D  
Sycamore IL 60178  
USA

#### Ledil Optics Technology (Shenzhen) Co., Ltd.

# 405 , Block B  
Casic Motor Building  
Shenzhen 518057  
P.R.CHINA

#### Local sales and technical support

[www.ledil.com/  
where\\_to\\_buy](http://www.ledil.com/where_to_buy)

#### Shipping locations

Salo, Finland  
Hong Kong, China

#### Distribution Partners

[www.ledil.com/  
where\\_to\\_buy](http://www.ledil.com/where_to_buy)