

---

**PWM Step-up DC/DC Controller**

---

NO.EA-109-220608

**OUTLINE**

The R1212D is a CMOS-based PWM step-up DC/DC controller with low supply current. Internally, the R1212D consists of an oscillator, a PWM comparator circuit, a reference voltage unit, an error amplifier, a reference current unit, a protection circuit, and an under voltage lockout (UVLO) circuit. A low ripple, high efficiency step-up DC/DC converter can be composed of this IC with some external components, or an inductor, a diode, a power MOSFET, divider resistors, and capacitors.

The maximum duty cycle and the soft start time are easily adjustable with external resistors and capacitors. In terms of maximum duty cycle, with or without internal limit can be set by mask options. As for the protection circuit, after the soft-starting time, if the maximum duty cycle is continued for a certain period, the R1212D latches the external driver with its off state, or the latch-type protection circuit works. The delay time for latch the state can be set with an external capacitor. To release the protection circuit, restart with power-on (Voltage supplier is equal or less than UVLO detector threshold level).

**FEATURES**

- Input Voltage Range ..... 2.2 V to 5.5 V
- Built-in Latch-type Protection Function (Output Delay Time can be set with an external capacitor)
- Two Options of Basic Oscillator Frequency ..... 700 kHz, 1.4 MHz, 300 kHz
- Maximum Duty Cycle/Soft-start time ..... Adjustable with external capacitors  
(If internal limit is set by version, Typ. 90% or Typ. 91.5%)
- High Reference Voltage Accuracy .....  $\pm 1.5\%$
- UVLO Threshold level ..... Typ. 1.9 V/ 2.1 V/ 2.8 V by mask option
- Small Temperature Coefficient of Reference Voltage ..... Typ.  $\pm 150\text{ppm}/^\circ\text{C}$
- Package ..... SON-8

**APPLICATIONS**

- Constant Voltage Power Source for portable equipment
- Constant Voltage Power Source for LCD and CCD

### BLOCK DIAGRAM

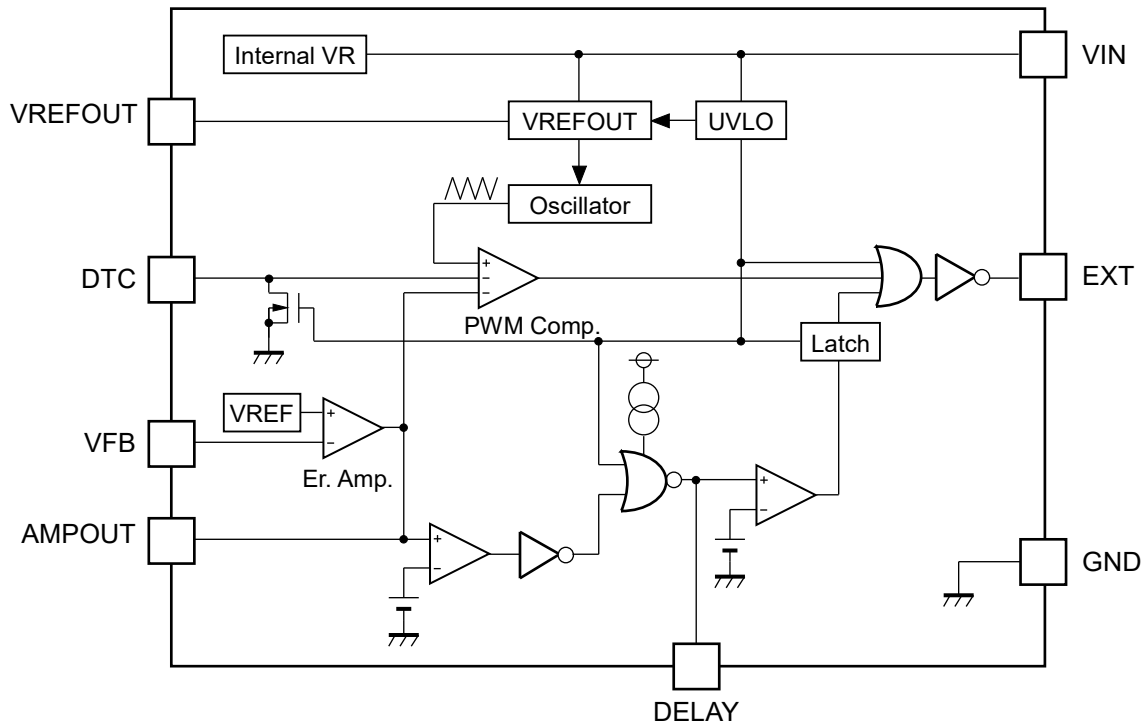

R1212D Block Diagram

## SELECTION GUIDE

The oscillator frequency, UVLO detector threshold, and oscillator maximum duty cycle internal limit for the ICs can be selected at the user's request.

### Selection Guide

Product Name	Package	Quantity per Reel	Pb Free	Halogen Free
R1212D10xx-TR-FE	SON-8	3,000 pcs	Yes	Yes

xx: The combination of the oscillator frequency, oscillator maximum duty cycle internal limit, and UVLO detect voltage can be designated.

Code	Oscillator Frequency	UVLO Detector Threshold	Internal Maximum Duty Limit
0A	Typ. 700 kHz	Typ. 1.9 V	No
0B	Typ. 1.4 MHz	Typ. 1.9 V	No
1A	Typ. 700 kHz	Typ. 2.1 V	Typ. 90%
1C	Typ. 300 kHz	Typ. 2.1 V	Typ. 91.5%
2A	Typ. 700 kHz	Typ. 2.8 V	Typ. 90%
2C	Typ. 300 kHz	Typ. 2.8 V	Typ. 91.5%

## PIN CONFIGURATION

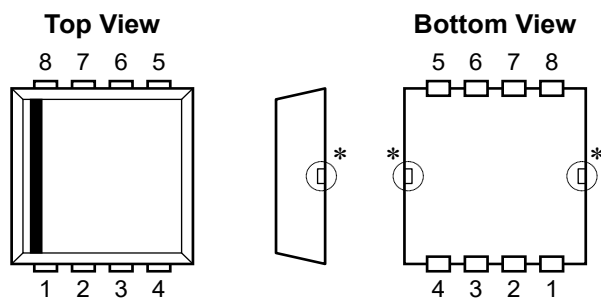

SON-8 Pin Configuration

## PIN DESCRIPTION

### Pin Description

Pin No	Symbol	Description
1	EXT	External FET Drive Pin (CMOS Output)
2	GND	Ground Pin
3	DTC	Pin for Setting Maximum Duty Cycle and Soft start time
4	DELAY	Pin for External Capacitor (for Setting Output Delay of Protection)
5	VFB	Feedback Pin for monitoring Output Voltage
6	VREFOUT	Reference Voltage Output Pin
7	AMPOUT	Amplifier Output Pin
8	VIN	Power Supply Pin for the IC

\* Tab suspension leads are GND level. (They are connected to the reverse side of this IC.) The tab suspension leads should be open and do not connect to other wires or land patterns.

## ABSOLUTE MAXIMUM RATINGS

### Absolute Maximum Ratings

(GND = 0 V)

Symbol	Item	Rating	Unit
$V_{IN}$	VIN Pin Voltage	6.5	V
$V_{EXT}$	EXT Pin Output Voltage	$-0.3 \sim V_{IN} + 0.3$	V
$V_{DLY}$	DELAY Pin Voltage	$-0.3 \sim V_{IN} + 0.3$	V
$V_{REFOUT}$	VREFOUT Pin Voltage	$-0.3 \sim V_{IN} + 0.3$	V
$V_{AMP}$	AMPOUT Pin Voltage	$-0.3 \sim V_{IN} + 0.3$	V
$V_{FB}$	DTC Pin Voltage	$-0.3 \sim V_{IN} + 0.3$	V
$V_{DTC}$	VFB Pin Voltage	$-0.3 \sim V_{IN} + 0.3$	V
$I_{AMP}$	AMPOUT Pin Current	$\pm 10$	V
$I_{ROUT}$	VREFOUT Pin Current	30	mA
$I_{EXT}$	EXT Pin Inductor Drive Output Current	$\pm 80$	mA
$P_D$	Power Dissipation (SON-8) (Standard Test Land Pattern)*	480	mW
$T_{opt}$	Operating Temperature Range	$-40 \sim 85$	$^{\circ}\text{C}$
$T_{stg}$	Storage Temperature Range	$-55 \sim 125$	$^{\circ}\text{C}$

\* For Power Dissipation, please refer to PACKAGE INFORMATION.

### ABSOLUTE MAXIMUM RATINGS

Electronic and mechanical stress momentarily exceeded absolute maximum ratings may cause the permanent damages and may degrade the life time and safety for both device and system using the device in the field. The functional operation at or over these absolute maximum ratings is not assured.

### RECOMMENDED OPERATING CONDITIONS (ELECTRICAL CHARACTERISTICS)

All of electronic equipment should be designed that the mounted semiconductor devices operate within the recommended operating conditions. The semiconductor devices cannot operate normally over the recommended operating conditions, even if when they are used over such conditions by momentary electronic noise or surge. And the semiconductor devices may receive serious damage when they continue to operate over the recommended operating conditions.

## ELECTRICAL CHARACTERISTICS

### R1212D100A Electrical Characteristics

(Topt = 25°C)

Symbol	Item	Conditions	Min.	Typ.	Max.	Unit
V <sub>IN</sub>	Operating Input Voltage		2.2		5.5	V
V <sub>FB</sub>	VFB Voltage Tolerance	V <sub>IN</sub> = 3.3 V	0.985	1.000	1.015	V
$\frac{\Delta V_{FB}}{\Delta V_{IN}}$	VFB Voltage Line Regulation	V <sub>IN</sub> = 2.2 V to 5.5 V		3		mV
$\frac{\Delta V_{FB}}{\Delta T_{opt}}$	VFB Voltage Temperature Coefficient	-40°C ≤ Topt ≤ 85°C		±150		ppm/°C
I <sub>FB</sub>	VFB Input Current	V <sub>IN</sub> = 5.5 V, V <sub>FB</sub> = 0 V or 5.5 V	-0.1		0.1	μA
A <sub>v</sub>	Open Loop Voltage Gain	V <sub>IN</sub> = 3.3 V		100		dB
f <sub>T</sub>	Unity Gain Frequency Band	V <sub>IN</sub> = 3.3 V, A <sub>v</sub> = 0		1.0		MHz
f <sub>osc</sub>	Oscillator Frequency	V <sub>IN</sub> = 3.3 V, V <sub>DLY</sub> = V <sub>FB</sub> = 0 V	595	700	805	kHz
$\frac{\Delta f_{osc}}{\Delta V_{IN}}$	Oscillator Frequency Line Regulation	V <sub>IN</sub> = 2.2 V to 5.5 V		50		kHz
$\frac{\Delta f_{osc}}{\Delta T_{opt}}$	Oscillator Frequency Temperature Coefficient	-40°C ≤ Topt ≤ 85°C		±1.0		kHz/°C
I <sub>DD1</sub>	Supply Current 1	V <sub>IN</sub> = 5.5 V, V <sub>DLY</sub> = V <sub>FB</sub> = 0 V, EXT at no load		600	1000	μA
V <sub>REFOUT</sub>	VREFOUT Voltage	V <sub>IN</sub> = 3.3 V, I <sub>ROUT</sub> = 1 mA	1.478	1.500	1.522	V
I <sub>OUT</sub>	VREFOUT Maximum Output Current	V <sub>IN</sub> = 3.3 V	10			mA
$\frac{\Delta V_{REFOUT}}{\Delta V_{IN}}$	VREFOUT Line Regulation	V <sub>IN</sub> = 2.2 V to 5.5 V		5	10	mV
$\frac{\Delta V_{REFOUT}}{\Delta I_{ROUT}}$	VREFOUT Load Regulation	V <sub>IN</sub> = 3.3 V, I <sub>ROUT</sub> = 0.1 mA to 5 mA		6	15	mV
I <sub>lim</sub>	VREFOUT Short Current Limit	V <sub>IN</sub> = 3.3 V, V <sub>REFOUT</sub> = 0 V		20		mA
$\frac{\Delta V_{REFOUT}}{\Delta T_{opt}}$	VREFOUT Voltage Temperature Coefficient	-40°C ≤ Topt ≤ 85°C		±150		ppm/°C
R <sub>EXTH</sub>	EXT "H" ON Resistance	V <sub>IN</sub> = 3.3 V, I <sub>EXT</sub> = -50 mA		2.5	6.0	Ω
R <sub>EXTL</sub>	EXT "L" ON Resistance	V <sub>IN</sub> = 3.3 V, I <sub>EXT</sub> = 50 mA		1.5	4.0	Ω
t <sub>r</sub>	EXT Rising Time	V <sub>IN</sub> = 3.3 V, C <sub>L</sub> = 1000 pF		12		ns
t <sub>f</sub>	EXT Falling Time	V <sub>IN</sub> = 3.3 V, C <sub>L</sub> = 1000 pF		8		ns
I <sub>DLY1</sub>	DELAY Pin Charge Current	V <sub>IN</sub> = 3.3 V, V <sub>DLY</sub> = 0 V, V <sub>FB</sub> = 0 V	3.0	5.5	8.0	μA
I <sub>DLY2</sub>	DELAY Pin Discharge Current	V <sub>IN</sub> = V <sub>FB</sub> = 2.2 V, V <sub>DLY</sub> = 0.1 V	0.08	0.20	0.36	mA
V <sub>DLY</sub>	DELAY Pin Detector Threshold	V <sub>IN</sub> = 3.3 V, V <sub>FB</sub> = 0 V, V <sub>DLY</sub> = 0 V → 2 V	0.95	1.00	1.05	V
V <sub>UVLO1</sub>	UVLO Detector Threshold	V <sub>IN</sub> = 3.3 V → 0 V, V <sub>DLY</sub> = V <sub>FB</sub> = 0 V	1.8	1.9	2.0	V
V <sub>UVLO2</sub>	UVLO Released Voltage	V <sub>IN</sub> = 0 V → 3.3 V, V <sub>DLY</sub> = V <sub>FB</sub> = 0 V		V <sub>UVLO1</sub> + 0.2	2.2	V
V <sub>DTC0</sub>	Duty = 0% DTC Pin Voltage	V <sub>IN</sub> = 3.3 V	0.05	0.18	0.25	V
V <sub>DTC20</sub>	Duty = 20% DTC Pin Voltage	V <sub>IN</sub> = 3.3 V		0.3		V
V <sub>DTC80</sub>	Duty = 80% DTC Pin Voltage	V <sub>IN</sub> = 3.3 V		0.75		V
V <sub>DTC100</sub>	Duty = 100% DTC Pin Voltage	V <sub>IN</sub> = 3.3 V	0.80	0.87	1.00	V
I <sub>AMPH</sub>	AMP "H" Output Current	V <sub>IN</sub> = 3.3 V, V <sub>AMP</sub> = 1.0 V, V <sub>FB</sub> = 0.9 V	0.5	1.0	1.8	mA
I <sub>AMPL</sub>	AMP "L" Output Current	V <sub>IN</sub> = 3.3 V, V <sub>AMP</sub> = 1.0 V, V <sub>FB</sub> = 1.1 V	60	100	160	μA

## R1212D100B Electrical Characteristics

(Topt = 25°C)

Symbol	Item	Conditions	Min.	Typ.	Max.	Unit
V <sub>IN</sub>	Operating Input Voltage		2.2		5.5	V
V <sub>FB</sub>	VFB Voltage Tolerance	V <sub>IN</sub> = 3.3 V	0.985	1.000	1.015	V
$\frac{\Delta V_{FB}}{\Delta V_{IN}}$	VFB Voltage Line Regulation	V <sub>IN</sub> = 2.2 V to 5.5 V		3		mV
$\frac{\Delta V_{FB}}{\Delta T_{opt}}$	VFB Voltage Temperature Coefficient	-40°C ≤ T <sub>opt</sub> ≤ 85°C		±150		ppm/°C
I <sub>FB</sub>	VFB Input Current	V <sub>IN</sub> = 5.5 V, V <sub>FB</sub> = 0 V or 5.5 V	-0.1		0.1	μA
A <sub>v</sub>	Open Loop Voltage Gain	V <sub>IN</sub> = 3.3 V		100		dB
f <sub>r</sub>	Unity Gain Frequency Band	V <sub>IN</sub> = 3.3 V, A <sub>v</sub> = 0		1.0		MHz
f <sub>osc</sub>	Oscillator Frequency	V <sub>IN</sub> = 3.3 V, V <sub>DLY</sub> = V <sub>FB</sub> = 0 V	1.19	1.40	1.61	MHz
$\frac{\Delta f_{osc}}{\Delta V_{IN}}$	Oscillator Frequency Line Regulation	V <sub>IN</sub> = 2.2 V to 5.5 V		100		kHz
$\frac{\Delta f_{osc}}{\Delta T_{opt}}$	Oscillator Frequency Temperature Coefficient	-40°C ≤ T <sub>opt</sub> ≤ 85°C		±2.0		kHz/°C
I <sub>DD1</sub>	Supply Current 1	V <sub>IN</sub> = 5.5 V, V <sub>DLY</sub> = V <sub>FB</sub> = 0 V EXT at no load		900	1800	μA
V <sub>REFOUT</sub>	VREFOUT Voltage	V <sub>IN</sub> = 3.3 V, I <sub>ROUT</sub> = 1 mA	1.478	1.500	1.522	V
I <sub>OUT</sub>	VREFOUT Maximum Output Current	V <sub>IN</sub> = 3.3 V	10			mA
$\frac{\Delta V_{REFOUT}}{\Delta V_{IN}}$	VREFOUT Line Regulation	V <sub>IN</sub> = 2.2 V to 5.5 V		5	10	mV
$\frac{\Delta V_{REFOUT}}{\Delta I_{ROUT}}$	VREFOUT Load Regulation	V <sub>IN</sub> = 3.3 V, I <sub>ROUT</sub> = 0.1 mA to 5 mA		6	15	mV
I <sub>lim</sub>	VREFOUT Short Current Limit	V <sub>IN</sub> = 3.3 V, V <sub>REFOUT</sub> = 0 V		20		mA
$\frac{\Delta V_{REFOUT}}{\Delta T_{opt}}$	VREFOUT Voltage Temperature Coefficient	-40°C ≤ T <sub>opt</sub> ≤ 85°C		±150		ppm/°C
R <sub>EXTH</sub>	EXT "H" ON Resistance	V <sub>IN</sub> = 3.3 V, I <sub>EXT</sub> = -50 mA		2.5	6.0	Ω
R <sub>EXTL</sub>	EXT "L" ON Resistance	V <sub>IN</sub> = 3.3 V, I <sub>EXT</sub> = 50 mA		1.5	4.0	Ω
t <sub>r</sub>	EXT Rising Time	V <sub>IN</sub> = 3.3 V, C <sub>L</sub> = 1000 pF		12		ns
t <sub>f</sub>	EXT Falling Time	V <sub>IN</sub> = 3.3 V, C <sub>L</sub> = 1000 pF		8		ns
I <sub>DLY1</sub>	DELAY Pin Charge Current	V <sub>IN</sub> = 3.3 V, V <sub>DLY</sub> = V <sub>FB</sub> = 0 V	3.0	5.5	8.0	μA
I <sub>DLY2</sub>	DELAY Pin Discharge Current	V <sub>IN</sub> = V <sub>FB</sub> = 2.2 V, V <sub>DLY</sub> = 0.1 V	0.08	0.20	0.36	mA
V <sub>DLY</sub>	DELAY Pin Detector Threshold	V <sub>IN</sub> = 3.3 V, V <sub>FB</sub> = 0 V, V <sub>DLY</sub> = 0 V → 2 V	0.95	1.00	1.05	V
V <sub>UVLO1</sub>	UVLO Detector Threshold	V <sub>IN</sub> = 3.3 V → 0 V, V <sub>DLY</sub> = V <sub>FB</sub> = 0 V	1.8	1.9	2.0	V
V <sub>UVLO2</sub>	UVLO Released Voltage	V <sub>IN</sub> = 0 V → 3.3 V, V <sub>DLY</sub> = V <sub>FB</sub> = 0 V		V <sub>UVLO1</sub> +0.2	2.2	V
V <sub>DTC0</sub>	Duty = 0% DTC Pin Voltage	V <sub>IN</sub> = 3.3 V	0.05	0.18	0.25	V
V <sub>DTC20</sub>	Duty = 20% DTC Pin Voltage	V <sub>IN</sub> = 3.3 V		0.3		V
V <sub>DTC80</sub>	Duty = 80% DTC Pin Voltage	V <sub>IN</sub> = 3.3 V		0.75		V
V <sub>DTC100</sub>	Duty = 100% DTC Pin Voltage	V <sub>IN</sub> = 3.3 V	0.80	0.87	1.00	V
I <sub>AMPH</sub>	AMP "H" Output Current	V <sub>IN</sub> = 3.3 V, V <sub>AMP</sub> = 1.0 V, V <sub>FB</sub> = 0.9 V	0.5	1.0	1.8	mA
I <sub>AMPL</sub>	AMP "L" Output Current	V <sub>IN</sub> = 3.3 V, V <sub>AMP</sub> = 1.0 V, V <sub>FB</sub> = 1.1 V	60	100	160	μA

## R1212D101A Electrical Characteristics

(T<sub>opt</sub> = 25°C)

Symbol	Item	Conditions	Min.	Typ.	Max.	Unit
V <sub>IN</sub>	Operating Input Voltage		2.5		5.5	V
V <sub>FB</sub>	VFB Voltage Tolerance	V <sub>IN</sub> = 3.3 V	0.985	1.000	1.015	V
$\frac{\Delta V_{FB}}{\Delta V_{IN}}$	VFB Voltage Line Regulation	V <sub>IN</sub> = 2.5 V to 5.5 V		3		mV
$\frac{\Delta V_{FB}}{\Delta T_{opt}}$	VFB Voltage Temperature Coefficient	-40°C ≤ T <sub>opt</sub> ≤ 85°C		±150		ppm/°C
I <sub>FB</sub>	VFB Input Current	V <sub>IN</sub> = 5.5 V, V <sub>FB</sub> = 0 V or 5.5 V	-0.1		0.1	μA
A <sub>v</sub>	Open Loop Voltage Gain	V <sub>IN</sub> = 3.3 V		100		dB
f <sub>r</sub>	Unity Gain Frequency Band	V <sub>IN</sub> = 3.3 V, A <sub>v</sub> = 0		1.0		MHz
f <sub>osc</sub>	Oscillator Frequency	V <sub>IN</sub> = 3.3 V, V <sub>DLY</sub> = V <sub>FB</sub> = 0 V	595	700	805	kHz
$\frac{\Delta f_{osc}}{\Delta V_{IN}}$	Oscillator Frequency Line Regulation	V <sub>IN</sub> = 2.5 V to 5.5 V		50		kHz
$\frac{\Delta f_{osc}}{\Delta T_{opt}}$	Oscillator Frequency Temperature Coefficient	-40°C ≤ T <sub>opt</sub> ≤ 85°C		±1.0		kHz/°C
I <sub>DD1</sub>	Supply Current 1	V <sub>IN</sub> = 5.5 V, V <sub>DLY</sub> = V <sub>FB</sub> = 0 V, EXT at no load		600	1000	μA
V <sub>REFOUT</sub>	VREFOUT Voltage	V <sub>IN</sub> = 3.3 V, I <sub>ROUT</sub> = 1 mA	1.478	1.500	1.522	V
I <sub>OUT</sub>	VREFOUT Maximum Output Current	V <sub>IN</sub> = 3.3 V	10			mA
$\frac{\Delta V_{REFOUT}}{\Delta V_{IN}}$	VREFOUT Line Regulation	V <sub>IN</sub> = 2.5 V to 5.5 V		5	10	mV
$\frac{\Delta V_{REFOUT}}{\Delta I_{ROUT}}$	VREFOUT Load Regulation	V <sub>IN</sub> = 3.3 V, I <sub>ROUT</sub> = 0.1 mA ~ 5 mA		6	15	mV
I <sub>lim</sub>	VREFOUT Short Current Limit	V <sub>IN</sub> = 3.3 V, V <sub>REFOUT</sub> = 0 V		20		mA
$\frac{\Delta V_{REFOUT}}{\Delta T_{opt}}$	VREFOUT Voltage Temperature Coefficient	-40°C ≤ T <sub>opt</sub> ≤ 85°C		±150		ppm/°C
R <sub>EXTH</sub>	EXT "H" ON Resistance	V <sub>IN</sub> = 3.3 V, I <sub>EXT</sub> = -50 mA		2.5	6.0	Ω
R <sub>EXTL</sub>	EXT "L" ON Resistance	V <sub>IN</sub> = 3.3 V, I <sub>EXT</sub> = 50 mA		1.5	4.0	Ω
t <sub>r</sub>	EXT Rising Time	V <sub>IN</sub> = 3.3 V, C <sub>L</sub> = 1000 pF		12		ns
t <sub>f</sub>	EXT Falling Time	V <sub>IN</sub> = 3.3 V, C <sub>L</sub> = 1000 pF		8		ns
I <sub>DLY1</sub>	DELAY Pin Charge Current	V <sub>IN</sub> = 3.3 V, V <sub>DLY</sub> = 0 V, V <sub>FB</sub> = 0 V	3.0	5.5	8.0	μA
I <sub>DLY2</sub>	DELAY Pin Discharge Current	V <sub>IN</sub> = V <sub>FB</sub> = 2.5 V, V <sub>DLY</sub> = 0.1 V	0.08	0.20	0.36	mA
V <sub>DLY</sub>	DELAY Pin Detector Threshold	V <sub>IN</sub> = 3.3 V, V <sub>FB</sub> = 0 V, V <sub>DLY</sub> = 0 V → 2 V	0.95	1.00	1.05	V
V <sub>UVLO1</sub>	UVLO Detector Threshold	V <sub>IN</sub> = 3.3 V → 0 V, V <sub>DLY</sub> = V <sub>FB</sub> = 0 V	2.0	2.1	2.2	V
V <sub>UVLO2</sub>	UVLO Released Voltage	V <sub>IN</sub> = 0 V → 3.3 V, V <sub>DLY</sub> = V <sub>FB</sub> = 0 V		V <sub>UVLO1</sub> +0.2	2.45	V
V <sub>DTC0</sub>	Duty = 0% DTC Pin Voltage	V <sub>IN</sub> = 3.3 V	0.05	0.18	0.25	V
V <sub>DTC20</sub>	Duty = 20% DTC Pin Voltage	V <sub>IN</sub> = 3.3 V		0.3		V
V <sub>DTC80</sub>	Duty = 80% DTC Pin Voltage	V <sub>IN</sub> = 3.3 V		0.75		V
Maxduty	Maximum Duty Cycle	V <sub>IN</sub> = 3.3 V	84	90	96	%
I <sub>AMPH</sub>	AMP "H" Output Current	V <sub>IN</sub> = 3.3 V, V <sub>AMP</sub> = 1.0 V, V <sub>FB</sub> = 0.9 V	0.5	1.0	1.8	mA
I <sub>AMPL</sub>	AMP "L" Output Current	V <sub>IN</sub> = 3.3 V, V <sub>AMP</sub> = 1.0 V, V <sub>FB</sub> = 1.1 V	60	100	160	μA



## R1212D101C Electrical Characteristics

(Topt = 25°C)

Symbol	Item	Conditions	Min.	Typ.	Max.	Unit
V <sub>IN</sub>	Operating Input Voltage		2.5		5.5	V
V <sub>FB</sub>	VFB Voltage Tolerance	V <sub>IN</sub> = 3.3 V	0.985	1.000	1.015	V
$\frac{\Delta V_{FB}}{\Delta V_{IN}}$	VFB Voltage Line Regulation	V <sub>IN</sub> = 2.5 V to 5.5 V		3		mV
$\frac{\Delta V_{FB}}{\Delta T_{opt}}$	VFB Voltage Temperature Coefficient	-40°C ≤ T <sub>opt</sub> ≤ 85°C		±150		ppm/°C
I <sub>FB</sub>	VFB Input Current	V <sub>IN</sub> = 5.5 V, V <sub>FB</sub> = 0 V or 5.5 V	-0.1		0.1	μA
A <sub>V</sub>	Open Loop Voltage Gain	V <sub>IN</sub> = 3.3 V		100		dB
f <sub>T</sub>	Unity Gain Frequency Band	V <sub>IN</sub> = 3.3 V, A <sub>V</sub> = 0		1.0		MHz
f <sub>osc</sub>	Oscillator Frequency	V <sub>IN</sub> = 3.3 V, V <sub>DLY</sub> = V <sub>FB</sub> = 0 V	240	300	360	kHz
$\frac{\Delta f_{osc}}{\Delta V_{IN}}$	Oscillator Frequency Line Regulation	V <sub>IN</sub> = 2.5 V to 5.5 V		25		kHz
$\frac{\Delta f_{osc}}{\Delta T_{opt}}$	Oscillator Frequency Temperature Coefficient	-40°C ≤ T <sub>opt</sub> ≤ 85°C		±0.5		kHz/°C
I <sub>DD1</sub>	Supply Current 1	V <sub>IN</sub> = 5.5 V, V <sub>DLY</sub> = V <sub>FB</sub> = 0 V, EXT at no load		400	800	μA
V <sub>REFOUT</sub>	VREFOUT Voltage	V <sub>IN</sub> = 3.3 V, I <sub>ROUT</sub> = 1 mA	1.478	1.500	1.522	V
I <sub>OUT</sub>	VREFOUT Maximum Output Current	V <sub>IN</sub> = 3.3 V	10			mA
$\frac{\Delta V_{REFOUT}}{\Delta V_{IN}}$	VREFOUT Line Regulation	V <sub>IN</sub> = 2.5 V to 5.5 V		5	10	mV
$\frac{\Delta V_{REFOUT}}{\Delta I_{ROUT}}$	VREFOUT Load Regulation	V <sub>IN</sub> = 3.3 V, I <sub>ROUT</sub> = 0.1 mA to 5 mA		6	15	mV
I <sub>lim</sub>	VREFOUT Short Current Limit	V <sub>IN</sub> = 3.3 V, V <sub>REFOUT</sub> = 0 V		20		mA
$\frac{\Delta V_{REFOUT}}{\Delta T_{opt}}$	VREFOUT Voltage Temperature Coefficient	-40°C ≤ T <sub>opt</sub> ≤ 85°C		±150		ppm/°C
R <sub>EXTH</sub>	EXT "H" ON Resistance	V <sub>IN</sub> = 3.3 V, I <sub>EXT</sub> = -50 mA		2.5	6.0	Ω
R <sub>EXTL</sub>	EXT "L" ON Resistance	V <sub>IN</sub> = 3.3 V, I <sub>EXT</sub> = 50 mA		1.5	4.0	Ω
t <sub>r</sub>	EXT Rising Time	V <sub>IN</sub> = 3.3 V, C <sub>L</sub> = 1000 pF		12		ns
t <sub>f</sub>	EXT Falling Time	V <sub>IN</sub> = 3.3 V, C <sub>L</sub> = 1000 pF		8		ns
I <sub>DLY1</sub>	DELAY Pin Charge Current	V <sub>IN</sub> = 3.3 V, V <sub>DLY</sub> = 0 V, V <sub>FB</sub> = 0 V	2.0	4.5	7.0	μA
I <sub>DLY2</sub>	DELAY Pin Discharge Current	V <sub>IN</sub> = V <sub>FB</sub> = 2.5 V, V <sub>DLY</sub> = 0.1 V	0.08	0.20	0.36	mA
V <sub>DLY</sub>	DELAY Pin Detector Threshold	V <sub>IN</sub> = 3.3 V, V <sub>FB</sub> = 0 V, V <sub>DLY</sub> = 0 V → 2 V	0.95	1.00	1.05	V
V <sub>UVLO1</sub>	UVLO Detector Threshold	V <sub>IN</sub> = 3.3 V → 0 V, V <sub>DLY</sub> = V <sub>FB</sub> = 0 V	2.0	2.1	2.2	V
V <sub>UVLO2</sub>	UVLO Released Voltage	V <sub>IN</sub> = 0 V → 3.3 V, V <sub>DLY</sub> = V <sub>FB</sub> = 0 V		V <sub>UVLO1</sub> +0.2	2.45	V
V <sub>DTC0</sub>	Duty = 0% DTC Pin Voltage	V <sub>IN</sub> = 3.3 V	0.05	0.18	0.25	V
V <sub>DTC20</sub>	Duty = 20% DTC Pin Voltage	V <sub>IN</sub> = 3.3 V		0.3		V
V <sub>DTC80</sub>	Duty = 80% DTC Pin Voltage	V <sub>IN</sub> = 3.3 V		0.75		V
Maxduty	Maximum Duty Cycle	V <sub>IN</sub> = 3.3 V	85.5	91.5	97.5	%
I <sub>AMPH</sub>	AMP "H" Output Current	V <sub>IN</sub> = 3.3 V, V <sub>AMP</sub> = 1.0 V, V <sub>FB</sub> = 0.9 V	0.5	1.0	1.8	mA
I <sub>AMPL</sub>	AMP "L" Output Current	V <sub>IN</sub> = 3.3 V, V <sub>AMP</sub> = 1.0 V, V <sub>FB</sub> = 1.1 V	50	90	150	μA

## R1212D102A Electrical Characteristics

(T<sub>opt</sub> = 25°C)

Symbol	Item	Conditions	Min.	Typ.	Max.	Unit
V <sub>IN</sub>	Operating Input Voltage		3.3		5.5	V
V <sub>FB</sub>	VFB Voltage Tolerance	V <sub>IN</sub> = 3.3 V	0.985	1.000	1.015	V
$\frac{\Delta V_{FB}}{\Delta V_{IN}}$	VFB Voltage Line Regulation	V <sub>IN</sub> = 3.3 V to 5.5 V		3		mV
$\frac{\Delta V_{FB}}{\Delta T_{opt}}$	VFB Voltage Temperature Coefficient	-40°C ≤ T <sub>opt</sub> ≤ 85°C		±150		ppm/°C
I <sub>FB</sub>	VFB Input Current	V <sub>IN</sub> = 5.5V, V <sub>FB</sub> = 0 V or 5.5 V	-0.1		0.1	μA
A <sub>v</sub>	Open Loop Voltage Gain	V <sub>IN</sub> = 3.3 V		100		dB
f <sub>T</sub>	Unity Gain Frequency Band	V <sub>IN</sub> = 3.3 V, A <sub>v</sub> = 0		1.0		MHz
f <sub>osc</sub>	Oscillator Frequency	V <sub>IN</sub> = 3.3 V, V <sub>DLY</sub> = V <sub>FB</sub> = 0 V	595	700	805	kHz
$\frac{\Delta f_{osc}}{\Delta V_{IN}}$	Oscillator Frequency Line Regulation	V <sub>IN</sub> = 3.3 V to 5.5 V		50		kHz
$\frac{\Delta f_{osc}}{\Delta T_{opt}}$	Oscillator Frequency Temperature Coefficient	-40°C ≤ T <sub>opt</sub> ≤ 85°C		±1.0		kHz/°C
I <sub>DD1</sub>	Supply Current 1	V <sub>IN</sub> = 5.5 V, V <sub>DLY</sub> = V <sub>FB</sub> = 0 V, EXT at no load		600	1000	μA
V <sub>REFOUT</sub>	VREFOUT Voltage	V <sub>IN</sub> = 3.3 V, I <sub>ROUT</sub> = 1 mA	1.478	1.500	1.522	V
I <sub>OUT</sub>	VREFOUT Maximum Output Current	V <sub>IN</sub> = 3.3 V	10			mA
$\frac{\Delta V_{REFOUT}}{\Delta V_{IN}}$	VREFOUT Line Regulation	V <sub>IN</sub> = 3.3 V to 5.5 V		5	10	mV
$\frac{\Delta V_{REFOUT}}{\Delta I_{ROUT}}$	VREFOUT Load Regulation	V <sub>IN</sub> = 3.3 V, I <sub>ROUT</sub> = 0.1 mA ~ 5 mA		6	15	mV
I <sub>lim</sub>	VREFOUT Short Current Limit	V <sub>IN</sub> = 3.3 V, V <sub>REFOUT</sub> = 0 V		20		mA
$\frac{\Delta V_{REFOUT}}{\Delta T_{opt}}$	VREFOUT Voltage Temperature Coefficient	-40°C ≤ T <sub>opt</sub> ≤ 85°C		±150		ppm/°C
R <sub>EXTH</sub>	EXT "H" ON Resistance	V <sub>IN</sub> = 3.3 V, I <sub>EXT</sub> = -50 mA		2.5	6.0	Ω
R <sub>EXTL</sub>	EXT "L" ON Resistance	V <sub>IN</sub> = 3.3 V, I <sub>EXT</sub> = 50 mA		1.5	4.0	Ω
t <sub>r</sub>	EXT Rising Time	V <sub>IN</sub> = 3.3 V, C <sub>L</sub> = 1000 pF		12		ns
t <sub>f</sub>	EXT Falling Time	V <sub>IN</sub> = 3.3 V, C <sub>L</sub> = 1000 pF		8		ns
I <sub>DLY1</sub>	DELAY Pin Charge Current	V <sub>IN</sub> = 3.3 V, V <sub>DLY</sub> = 0 V, V <sub>FB</sub> = 0 V	3.0	5.5	8.0	μA
I <sub>DLY2</sub>	DELAY Pin Discharge Current	V <sub>IN</sub> = V <sub>FB</sub> = 3.3 V, V <sub>DLY</sub> = 0.1 V	0.08	0.20	0.36	mA
V <sub>DLY</sub>	DELAY Pin Detector Threshold	V <sub>IN</sub> = 3.3 V, V <sub>FB</sub> = 0 V, V <sub>DLY</sub> = 0 V → 2 V	0.95	1.00	1.05	V
V <sub>UVLO1</sub>	UVLO Detector Threshold	V <sub>IN</sub> = 3.3 V → 0 V, V <sub>DLY</sub> = V <sub>FB</sub> = 0 V	2.6	2.8	3.0	V
V <sub>UVLO2</sub>	UVLO Released Voltage	V <sub>IN</sub> = 0 V → 3.3 V, V <sub>DLY</sub> = V <sub>FB</sub> = 0 V		V <sub>UVLO1</sub> +0.25	3.3	V
V <sub>DTC0</sub>	Duty = 0% DTC Pin Voltage	V <sub>IN</sub> = 3.3 V	0.05	0.18	0.25	V
V <sub>DTC20</sub>	Duty = 20% DTC Pin Voltage	V <sub>IN</sub> = 3.3 V		0.3		V
V <sub>DTC80</sub>	Duty = 80% DTC Pin Voltage	V <sub>IN</sub> = 3.3 V		0.75		V
Maxduty	Maximum Duty Cycle	V <sub>IN</sub> = 3.3 V	84	90	96	%
I <sub>AMPH</sub>	AMP "H" Output Current	V <sub>IN</sub> = 3.3 V, V <sub>AMP</sub> = 1.0 V, V <sub>FB</sub> = 0.9 V	0.5	1.0	1.8	mA
I <sub>AMPL</sub>	AMP "L" Output Current	V <sub>IN</sub> = 3.3 V, V <sub>AMP</sub> = 1.0 V, V <sub>FB</sub> = 1.1 V	60	100	160	μA

## R1212D102C Electrical Characteristics

(T<sub>opt</sub> = 25°C)

Symbol	Item	Conditions	Min.	Typ.	Max.	Unit
V <sub>IN</sub>	Operating Input Voltage		3.3		5.5	V
V <sub>FB</sub>	VFB Voltage Tolerance	V <sub>IN</sub> = 3.3 V	0.985	1.000	1.015	V
$\frac{\Delta V_{FB}}{\Delta V_{IN}}$	VFB Voltage Line Regulation	V <sub>IN</sub> = 3.3 V to 5.5 V		3		mV
$\frac{\Delta V_{FB}}{\Delta T_{opt}}$	VFB Voltage Temperature Coefficient	-40°C ≤ T <sub>opt</sub> ≤ 85°C		±150		ppm/°C
I <sub>FB</sub>	VFB Input Current	V <sub>IN</sub> = 5.5 V, V <sub>FB</sub> = 0 V or 5.5 V	-0.1		0.1	μA
A <sub>V</sub>	Open Loop Voltage Gain	V <sub>IN</sub> = 3.3 V		100		dB
f <sub>T</sub>	Unity Gain Frequency Band	V <sub>IN</sub> = 3.3 V, A <sub>V</sub> = 0		1.0		MHz
f <sub>osc</sub>	Oscillator Frequency	V <sub>IN</sub> = 3.3 V, V <sub>DLY</sub> = V <sub>FB</sub> = 0 V	240	300	360	kHz
$\frac{\Delta f_{osc}}{\Delta V_{IN}}$	Oscillator Frequency Line Regulation	V <sub>IN</sub> = 3.3 V to 5.5 V		25		kHz
$\frac{\Delta f_{osc}}{\Delta T_{opt}}$	Oscillator Frequency Temperature Coefficient	-40°C ≤ T <sub>opt</sub> ≤ 85°C		±0.5		kHz/°C
I <sub>DD1</sub>	Supply Current 1	V <sub>IN</sub> = 5.5 V, V <sub>DLY</sub> = V <sub>FB</sub> = 0 V, EXT at noload		400	800	μA
V <sub>REFOUT</sub>	VREFOUT Voltage	V <sub>IN</sub> = 3.3 V, I <sub>ROUT</sub> = 1 mA	1.478	1.500	1.522	V
I <sub>OUT</sub>	VREFOUT Maximum Output Current	V <sub>IN</sub> = 3.3 V	10			mA
$\frac{\Delta V_{REFOUT}}{\Delta V_{IN}}$	VREFOUT Line Regulation	V <sub>IN</sub> = 3.3 V to 5.5 V		5	10	mV
$\frac{\Delta V_{REFOUT}}{\Delta I_{ROUT}}$	VREFOUT Load Regulation	V <sub>IN</sub> = 3.3 V, I <sub>ROUT</sub> = 0.1 mA ~ 5 mA		6	15	mV
I <sub>lim</sub>	VREFOUT Short Current Limit	V <sub>IN</sub> = 3.3 V, V <sub>REFOUT</sub> = 0 V		20		mA
$\frac{\Delta V_{REFOUT}}{\Delta T_{opt}}$	VREFOUT Voltage Temperature Coefficient	-40°C ≤ T <sub>opt</sub> ≤ 85°C		±150		ppm/°C
R <sub>EXTH</sub>	EXT "H" ON Resistance	V <sub>IN</sub> = 3.3 V, I <sub>EXT</sub> = -50 mA		2.5	6.0	Ω
R <sub>EXTL</sub>	EXT "L" ON Resistance	V <sub>IN</sub> = 3.3 V, I <sub>EXT</sub> = 50 mA		1.5	4.0	Ω
t <sub>r</sub>	EXT Rising Time	V <sub>IN</sub> = 3.3 V, C <sub>L</sub> = 1000 pF		12		ns
t <sub>f</sub>	EXT Falling Time	V <sub>IN</sub> = 3.3 V, C <sub>L</sub> = 1000 pF		8		ns
I <sub>DLY1</sub>	DELAY Pin Charge Current	V <sub>IN</sub> = 3.3 V, V <sub>DLY</sub> = 0 V, V <sub>FB</sub> = 0 V	2.0	4.5	7.0	μA
I <sub>DLY2</sub>	DELAY Pin Discharge Current	V <sub>IN</sub> = V <sub>FB</sub> = 3.3 V, V <sub>DLY</sub> = 0.1 V	0.08	0.20	0.36	mA
V <sub>DLY</sub>	DELAY Pin Detector Threshold	V <sub>IN</sub> = 3.3 V, V <sub>FB</sub> = 0 V, V <sub>DLY</sub> = 0 V → 2 V	0.95	1.00	1.05	V
V <sub>UVLO1</sub>	UVLO Detector Threshold	V <sub>IN</sub> = 3.3 V → 0 V, V <sub>DLY</sub> = V <sub>FB</sub> = 0 V	2.6	2.8	3.0	V
V <sub>UVLO2</sub>	UVLO Released Voltage	V <sub>IN</sub> = 0 V → 3.3 V, V <sub>DLY</sub> = V <sub>FB</sub> = 0 V		V <sub>UVLO1</sub> +0.25	3.30	V
V <sub>DTC0</sub>	Duty = 0% DTC Pin Voltage	V <sub>IN</sub> = 3.3 V	0.05	0.18	0.25	V
V <sub>DTC20</sub>	Duty = 20% DTC Pin Voltage	V <sub>IN</sub> = 3.3 V		0.3		V
V <sub>DTC80</sub>	Duty = 80% DTC Pin Voltage	V <sub>IN</sub> = 3.3 V		0.75		V
Maxduty	Maximum Duty Cycle	V <sub>IN</sub> = 3.3 V	85.5	91.5	97.5	%
I <sub>AMPH</sub>	AMP "H" Output Current	V <sub>IN</sub> = 3.3 V, V <sub>AMP</sub> = 1.0 V, V <sub>FB</sub> = 0.9 V	0.5	1.0	1.8	mA
I <sub>AMPL</sub>	AMP "L" Output Current	V <sub>IN</sub> = 3.3 V, V <sub>AMP</sub> = 1.0 V, V <sub>FB</sub> = 1.1 V	50	90	150	μA

## TYPICAL APPLICATIONS AND TECHNICAL NOTES

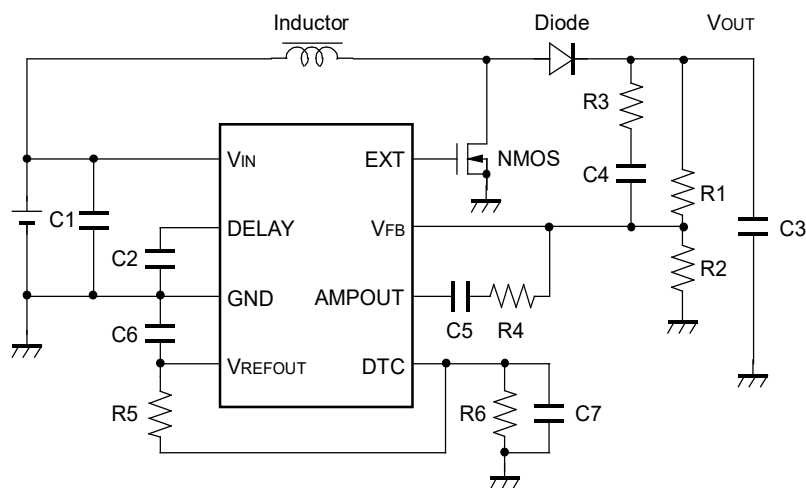

R1212D Typical Application

Inductor	VLF504012MT-100M (TDK: 10 $\mu$ H) [R1212DxxxA]				
	VLF504012MT-4R7M (TDK: 4.7 $\mu$ H) [R1212DxxxB]				
	VLF504012MT-220M (TDK: 22 $\mu$ H) [R1212DxxxC]				
NMOS	CPH6415 (Sanyo)				
Diode	CRS10I30A (Toshiba)				
C1	2.2 $\mu$ F	Set V <sub>out</sub>	5 V	10 V	15 V
C2	1 $\mu$ F	R1	120 k $\Omega$	180 k $\Omega$	140 k $\Omega$
C3	1.5 $\mu$ F	R2	30 k $\Omega$	20 k $\Omega$	10 k $\Omega$
C4	1000 pF [R1212DxxxA]	R3	1 k $\Omega$		
	680 pF [R1212DxxxB]	R4	4.7 k $\Omega$		
	1500 pF [R1212DxxxC]	R5	240 k $\Omega$		
C5	1000 pF [R1212DxxxA]	R6	300 k $\Omega$		
	680 pF [R1212DxxxB]				
	1500 pF [R1212DxxxC]				
C6	0.1 $\mu$ F				
C7	0.1 $\mu$ F				

- Use a 1  $\mu\text{F}$  or more capacitance value of bypass capacitor between VIN pin and GND, C1 as shown in the typical application above. Connect the capacitor as short as possible to the IC.
- In terms of the capacitor for setting delay time of the latch protection, C2 is shown in typical application above. Latch delay time depends on this C2 value. Refer to the Latch Protection Operation Timing Chart.
- Connect a 1  $\mu\text{F}$  or more value of capacitor between VOUT and GND, C3 as shown in typical application above. (Recommended value is from 10  $\mu\text{F}$  to 22  $\mu\text{F}$ .) If the operation of the composed DC/DC converter may be unstable, use a tantalum type capacitor instead of ceramic type
- Connect a capacitor between VREFOUT and GND, C6 as shown in typical application of the previous page. The capacitance value of C6 is between 0.1  $\mu\text{F}$  and 1.0  $\mu\text{F}$ .
- Output Voltage Setting Method and Phase Compensation Making Method  
The feedback voltage is controlled into 1.0 V. The output voltage can be set with divider resistors for voltage setting, R1 and R2 as shown in typical application of the previous page. Refer to the next formula.

$$\text{Output Voltage} = V_{\text{FB}} \times (R1 + R2) / R2$$

Output Voltage is adjustable with setting various resistor values combination. R1 + R2 should be equal or less than 500 k $\Omega$

As for the DC/DC converter, depending on the load current and external components such as L and C, phase may loss around 180°. In such case, phase margin becomes less and may be unstable. To avoid this situation, make the phase margin more.

The pole is made with external components L and C.

$$F_{\text{pole}} \sim 1 / \{2 \times \pi \times \sqrt{(L \times C3)}\}$$

C4, C5, R3, and R4 shown in the diagram are for making phase compensation. The gain of the system can be set with using these resistors and capacitors. Each value in the diagram is just an example. R4 and C5 make zero (the backward phase).

$$F_{\text{zero}} \sim 1 / (2 \times \pi \times R4 \times C5)$$

Choose the R4 and C5 value so as to make the cutoff frequency of this zero point close to the cutoff frequency of the pole by external components, L and C.

For example, supposed that L = 10  $\mu\text{H}$  and C<sub>OUT</sub> (C3) = 10  $\mu\text{F}$ , the cutoff frequency of the pole is approximately 16 kHz. Therefore make the cutoff frequency of the zero point close to 16 kHz. Then R4 = 4.7 k $\Omega$  and C5 = 1000 pF are appropriate values.

As for setting the gain, the ratio of the composite resistor ( $R_T$ :  $R_T = R_1 \times R_2 / (R_1 + R_2)$ ) to  $R_4$  is the key. If the  $R_4$  against the composite resistor,  $R_T$ , is large, the gain becomes also large. If the gain is large, the response characteristic is improved, however, too large gain makes the system be unstable.

If the spike noise of  $V_{OUT}$  may be large, the spike noise may be picked into  $V_{FB}$  pin, and the unstable operation may result. In this case, a resistor  $R_3$ , shown in typical application of the previous page. The recommended resistance value of  $R_3$  is in the range from  $1\text{ k}\Omega$  to  $5\text{ k}\Omega$ . Then, noise level will be decreased.

Further,  $R_1$  and  $C_4$  makes another zero point (the backward phase).

$$F_{\text{zero}} \sim 1 / (2 \times \pi \times R_1 \times C_4)$$

Make the cutoff frequency of this zero point be lower than the cutoff frequency of the pole by external components, or,  $L$  and  $C$ . Herein,  $R_1 = 180\text{ k}\Omega$  and  $C_4 = 1000\text{ pF}$  are appropriate values.

- Select the Power MOSFET, the diode, capacitors and the inductor within ratings (Voltage, Current, Power) of this IC. Choose the power MOSFET with low threshold voltage depending on the input voltage to be able to turn on the FET completely. Choose the diode with low  $V_F$  such as Schottky type with low reverse current  $I_R$ , and with fast switching speed. When an external transistor is switching, spike voltage may be generated caused by an inductor, therefore recommended voltage tolerance of capacitor connected to  $V_{OUT}$  is twice as much as the setting voltage or more.
- The soft-start time and the maximum duty cycle setting method  
The soft-start time and the maximum duty cycle can be set with  $R_5$ ,  $R_6$ , and  $C_7$  values connected to the  $V_{REFOUT}$  pin and the  $DTC$  pin. (Refer to the timing chart: Soft-start operation.)

## OUTPUT CURRENT AND SELECTION OF EXTERNAL COMPONENTS

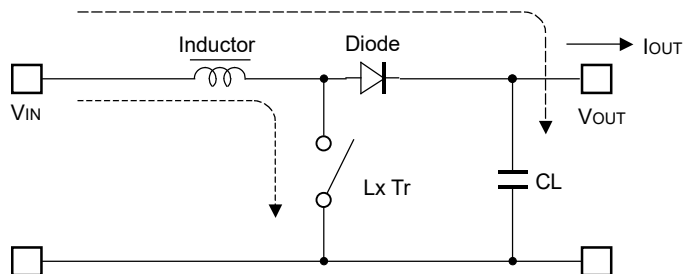

R1212D Typical Application

### Current Flowing through L

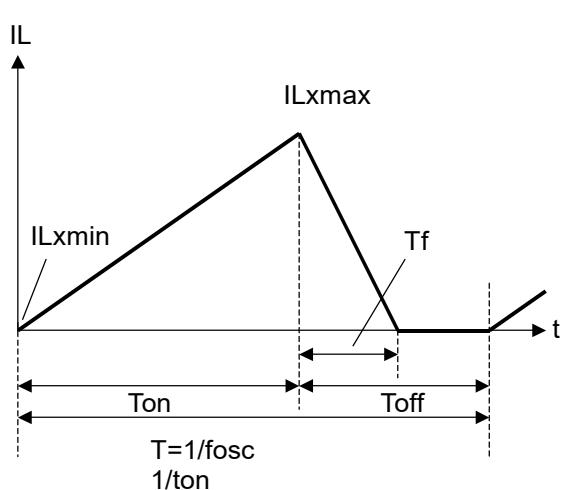

Discontinuous Mode

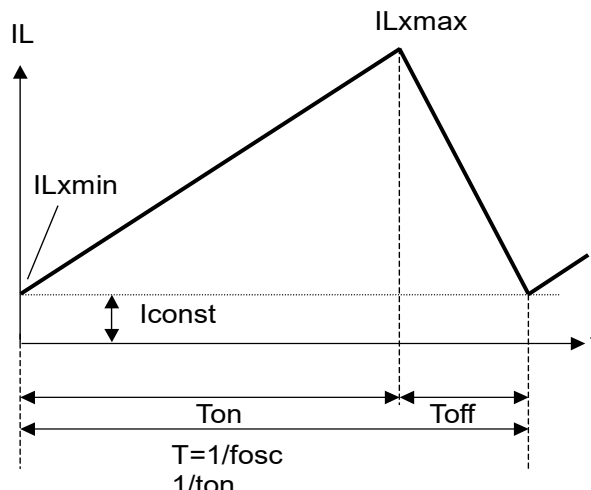

Continuous Mode

There are two modes, or discontinuous mode and continuous mode for the PWM step-up switching regulator depending on the continuous characteristic of inductor current. During on time of the transistor, when the voltage added on to the inductor is described as  $V_{IN}$ , the current is  $V_{IN} \times t/L$ . Therefore, the electric power,  $P_{ON}$ , which is supplied with input side, can be described as in next formula.

$$P_{ON} = \int_0^{T_{on}} V_{IN}^2 \times t/L dt \dots\dots\dots \text{Formula 1}$$

With the step-up circuit, electric power is supplied from power source also during off time. In this case, input current is described as  $(V_{OUT} - V_{IN}) \times t/L$ , therefore electric power,  $P_{OFF}$  is described as in next formula.

$$P_{OFF} = \int_0^{Tf} V_{IN} \times (V_{OUT} - V_{IN}) \times t/L dt \dots\dots\dots \text{Formula 2}$$

In this formula, Tf means the time of which the energy saved in the inductance is being emitted. Thus average electric power, or P<sub>AV</sub> is described as in the next formula.

$$P_{AV} = 1/(T_{ON} + T_{OFF}) \times \left\{ \int_0^{T_{ON}} V_{IN}^2 \times t/L dt + \int_0^{Tf} V_{IN} \times (V_{OUT} - V_{IN}) \times t/L dt \right\} \dots\dots\dots \text{Formula 3}$$

In PWM control, when Tf = Toff is true, the inductor current becomes continuous, then the operation of switching regulator becomes continuous mode. In the continuous mode, the deviation of the current is equal between on time and off time.

$$V_{IN} = T_{ON}/L = (V_{OUT} - V_{IN}) \times T_{OFF}/L \dots\dots\dots \text{Formula 4}$$

Further, the electric power, P<sub>AV</sub> is equal to output electric power, V<sub>OUT</sub> × I<sub>OUT</sub>, thus,

$$I_{OUT} = f_{OSC} \times V_{IN}^2 \times T_{ON}^2 / \{2 \times L \times (V_{OUT} - V_{IN})\} = V_{IN}^2 \times T_{ON} / (2 \times L \times V_{OUT}) \dots\dots\dots \text{Formula 5}$$

When I<sub>OUT</sub> becomes more than formula 5, the current flows through the inductor, then the mode becomes continuous. The continuous current through the inductor is described as I<sub>const</sub>, then,

$$I_{OUT} = f_{OSC} \times V_{IN}^2 \times T_{ON}^2 / \{2 \times L \times (V_{OUT} - V_{IN})\} + V_{IN} \times I_{const} / V_{OUT} \dots\dots\dots \text{Formula 6}$$

In this moment, the peak current, IL<sub>xmax</sub> flowing through the inductor and the driver Tr. is described as follows:

$$I_{Lx\max} = I_{const} + V_{IN} \times T_{ON}/L \dots\dots\dots \text{Formula 7}$$

With the formula 4,6, and IL<sub>xmax</sub> is,

$$I_{Lx\max} = V_{OUT} / V_{IN} \times I_{OUT} + V_{IN} \times T_{ON} / (2 \times L) \dots\dots\dots \text{Formula 8}$$

Therefore, peak current is more than I<sub>OUT</sub>. Considering the value of IL<sub>xmax</sub>, the condition of input and output, and external components should be selected.

In the formula 7, peak current IL<sub>xmax</sub> at discontinuous mode can be calculated. Put I<sub>const</sub>=0 in the formula. The explanation above is based on the ideal calculation, and the loss caused by L<sub>x</sub> switch and external components is not included. The actual maximum output current is between 50% and 80% of the calculation. Especially, when the IL<sub>x</sub> is large, or V<sub>IN</sub> is low, the loss of V<sub>IN</sub> is generated with the on resistance of the switch. As for V<sub>OUT</sub>, Vf (as much as 0.3V) of the diode should be considered.



## TIMING CHART

### Soft-start Operation

The timing chart below describes the state of each pin from the power-on until the IC entering the stable operation. By raising the voltage of the DTC pin slowly, the switching duty cycle is limited, and prevent the drastic voltage rising (over-shoot) and inrush current.

When the  $V_{IN}$  voltage becomes equal or more than the UVLO released voltage ( $V_{UVLO}+V_{HYS}$ ),  $V_{REFOUT}$  operation starts. Following with the increase of the voltage level of  $V_{REFOUT}$ , the internal oscillator begins to operate, then the DTC voltage is also rising, then, soft-start operation starts. When the DTC voltage crosses the chopping wave level inside the IC, EXT pin starts switching, then, step-up operation begins. During this term, the output voltage does not reach the set output voltage. Therefore the output of the amplifier is "H". Besides, the protection circuit may work and the IC charges the DELAY pin. Because of this, the soft-start time should be set shorter than the latch protection delay time.

After the initial stage, when the output voltage reaches the set output voltage, the level of AMPOUT becomes the normal state. In other words, the level is determined with the input voltage, the output voltage, and the output current. When the level of AMPOUT becomes falling, charging the DELAY pin stops and discharges to the GND. The soft-start time (the time for the DTC pin voltage becoming to  $V_{DTC}$  level) can be estimated with the next formula.

$T \cong 1/\alpha \times \ln(V_{DTC} \times \alpha / \beta + 1)$ , herein,  $\alpha = -1/C7 \times (1/R5 + 1/R6)$ , and  $\beta = V_{REFOUT} / (C7 \times R5)$ .

$$V_{DTC} = V_{REF} \times R6 / (R5 + R6) \times 0.95$$

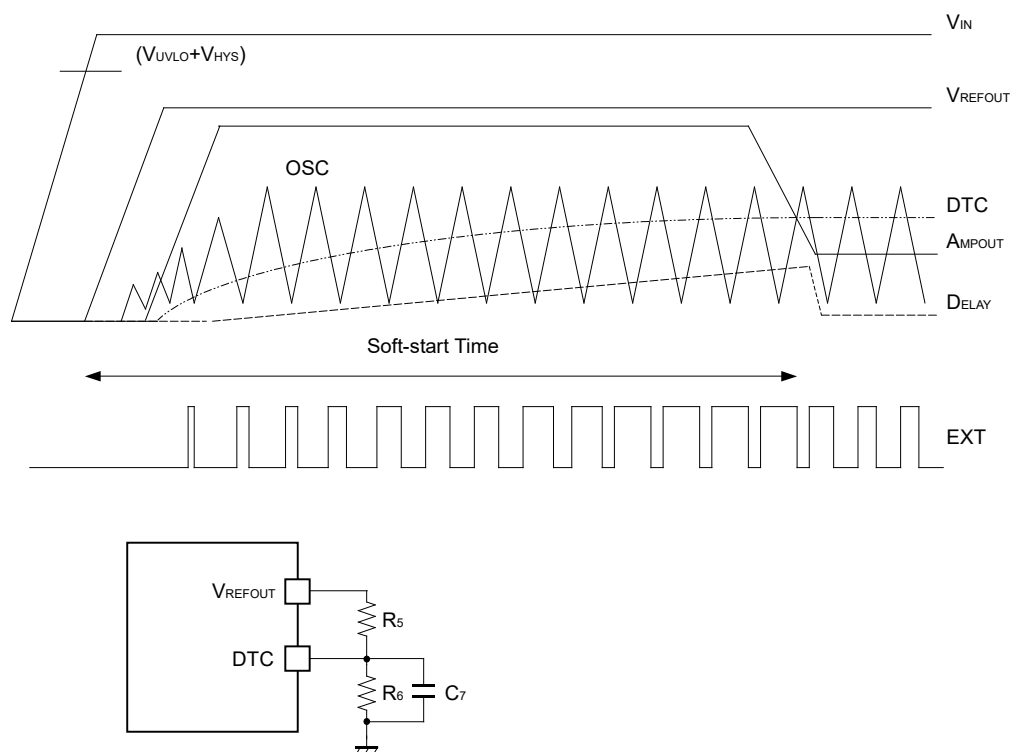

### Latch Protection Operation

The operation of Latch protection circuit is as follows: When AMPOUT becomes "H" and the IC detects maximum duty cycle, charge to an external capacitor, C2 of DELAY pin starts. The maximum duty cycle continues and the voltage of DELAY pin reaches delay voltage detector threshold,  $V_{DLY}$ , outputs "L" to EXT pin and turns off the external power MOSFET.

To release the latch protection operation, make the supply voltage down to UVLO detector threshold or lower, and make it rise up to the normal input voltage.

Once after becoming the maximum duty cycle, if the duty cycle decreases before latch operation works, the charging the capacitor stops immediately, and the DELAY pin voltage is fixed at GND level with  $I_{DLY2}$ .

The delay time of latch protection can be calculated with C2,  $V_{DLY}$ , and the delay pin charge current,  $I_{DLY1}$ , as in the next formula.

$$t = C2 \times V_{DLY} / I_{DLY1}$$

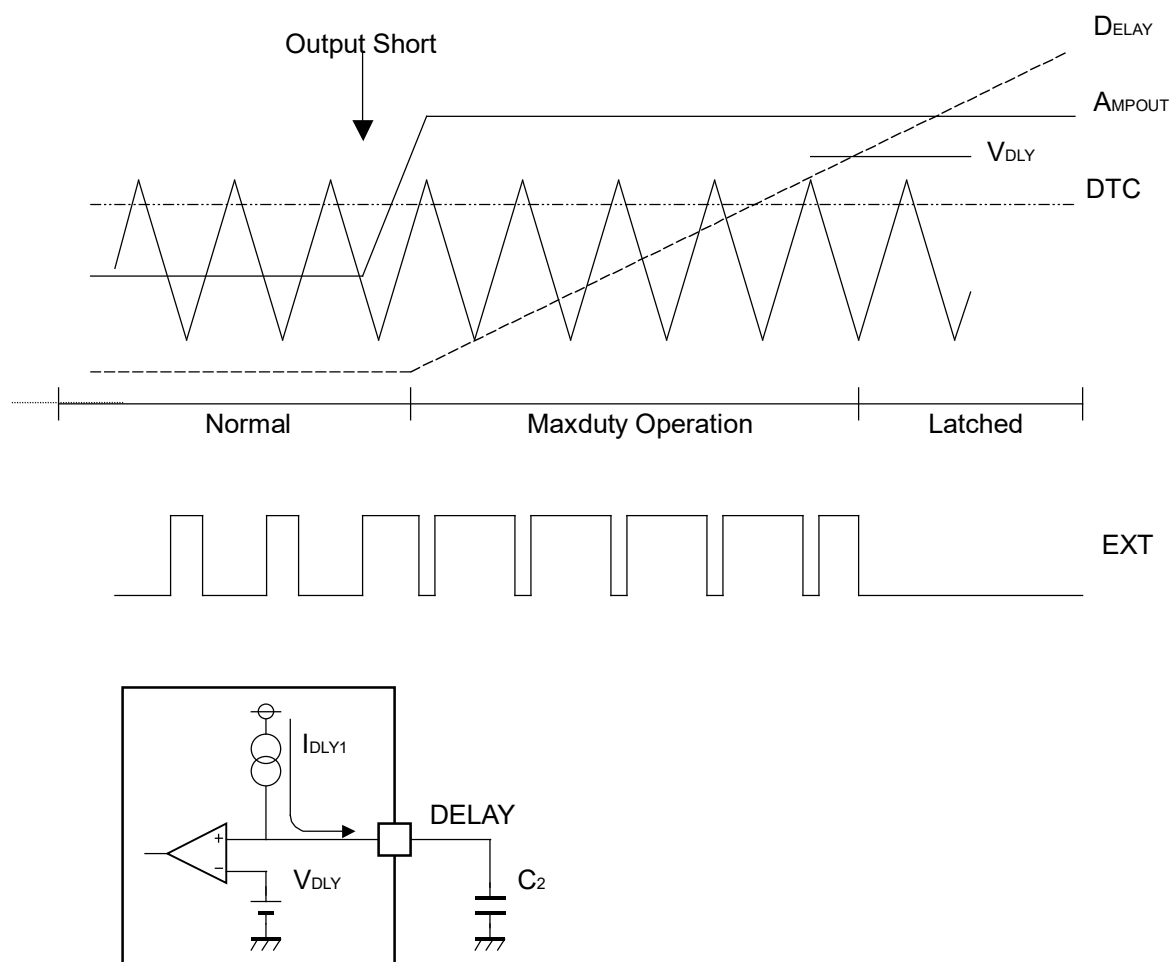

## TEST CIRCUITS

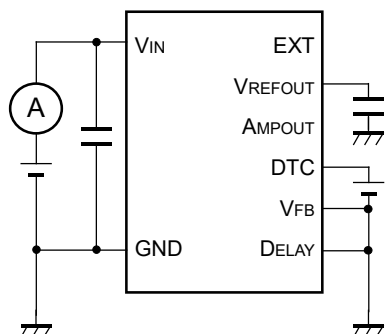

Fig. 1 Consumption Current Test Circuit

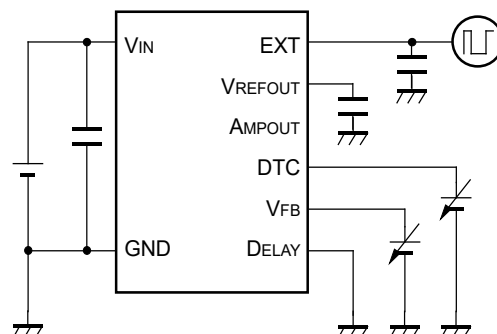

Fig. 2 Oscillator Frequency,  $V_{FB}$  Voltage, Duty Cycle, EXT Rising Time/ Falling Time Test Circuit

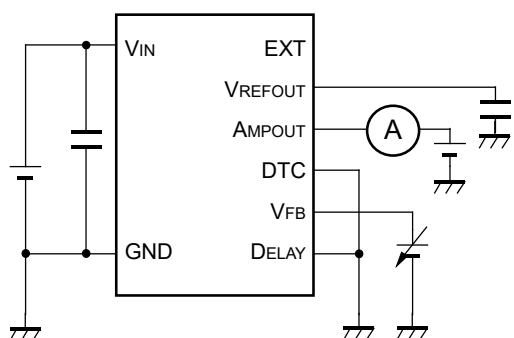

Fig. 3 AMP "L" Output Current/ "H" Output Current Test Circuit

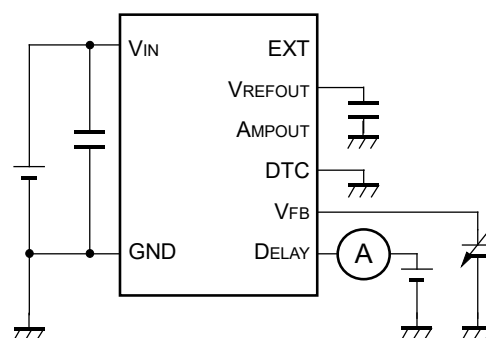

Fig. 4  $D_{DELAY}$  Pin Charge Current/ Discharge Current Test Circuit

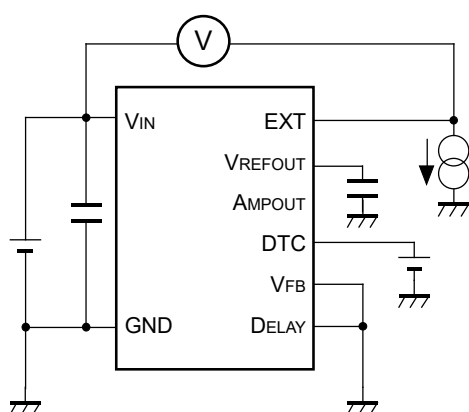

Fig. 5 EXT "H" ON Resistance Test Circuit

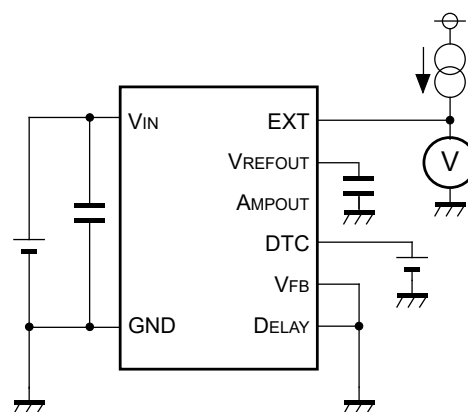

Fig. 6 EXT "L" ON Resistance Test Circuit

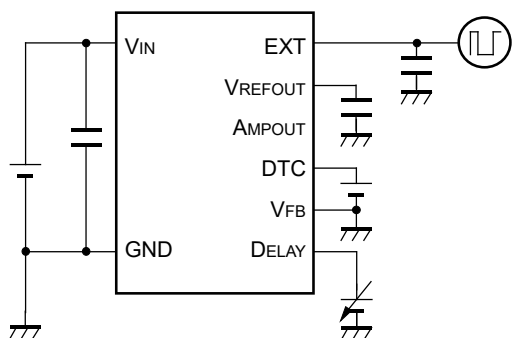

Fig. 7 DELAY Pin Detector Threshold Test Circuit

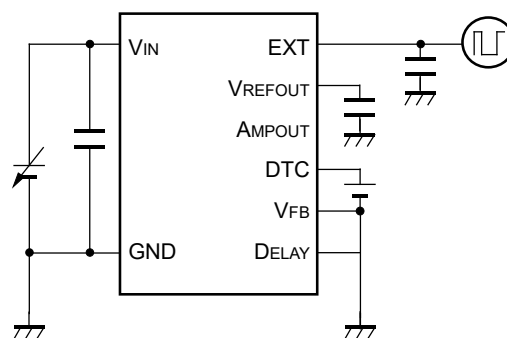

Fig. 8 UVLO Detector Threshold/ Released Voltage Test Circuit

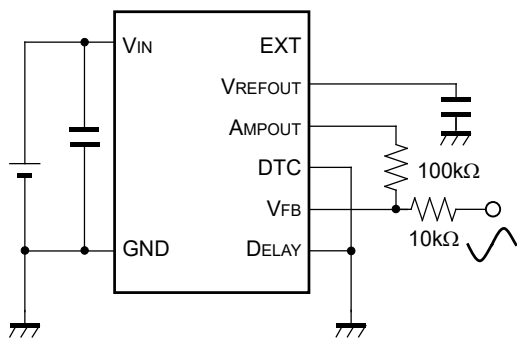

Fig. 9 Error AMP Gain/ Phase Test Circuit

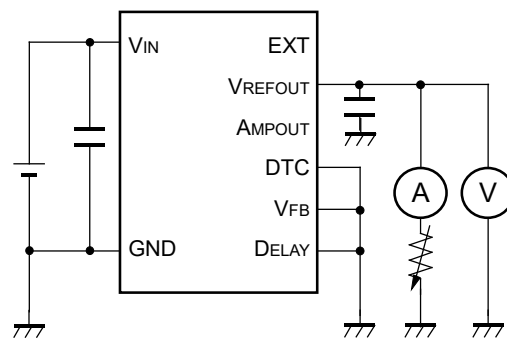

Fig. 10 VREFOUT Voltage Test Current

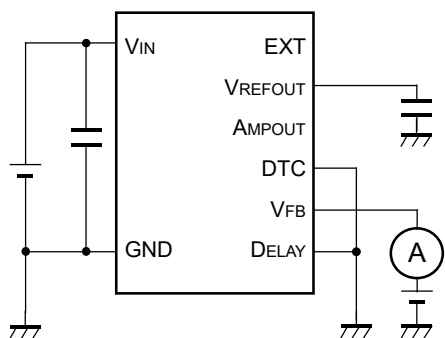

Fig. 11 VFB Leakage Current Test Circuit

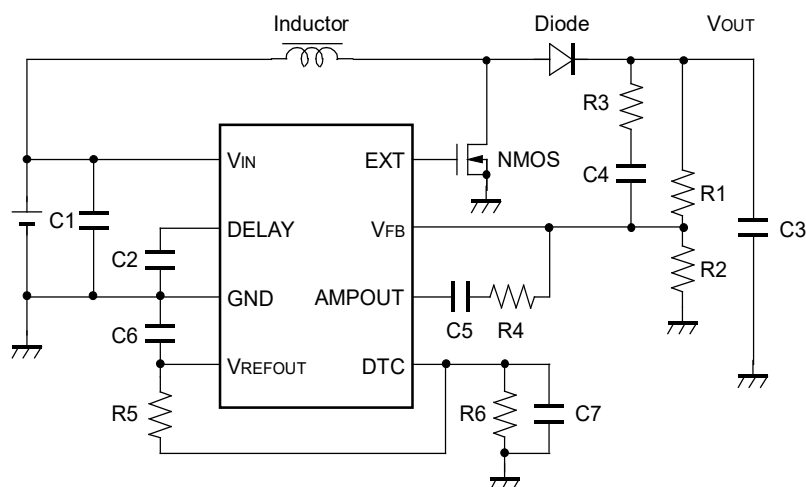
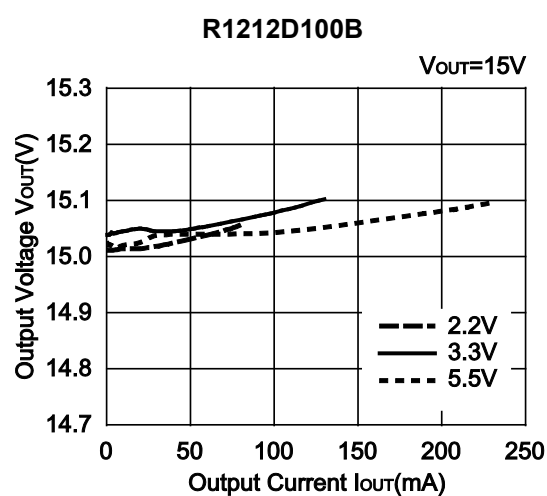
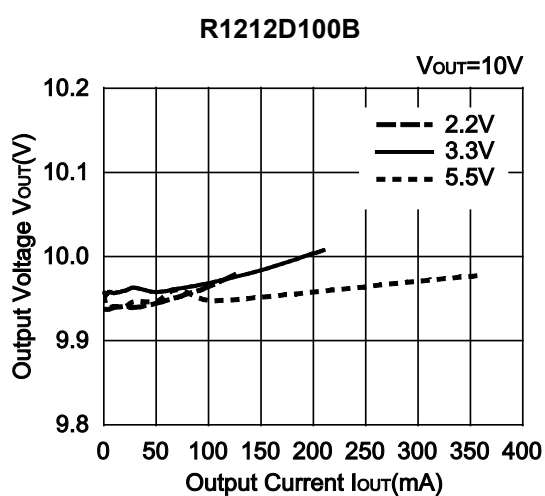
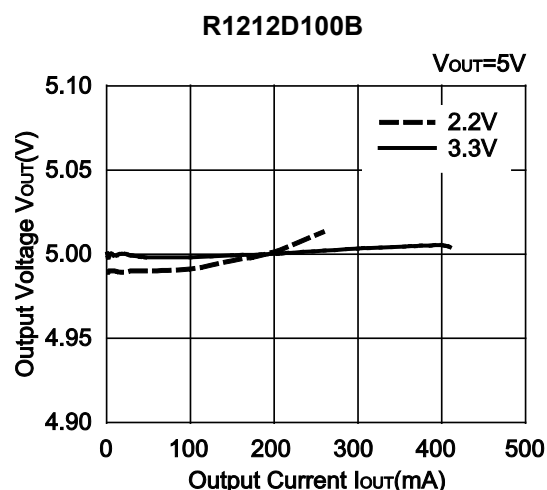
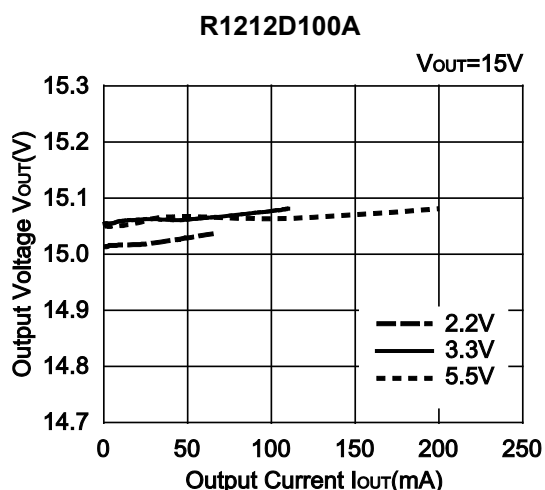
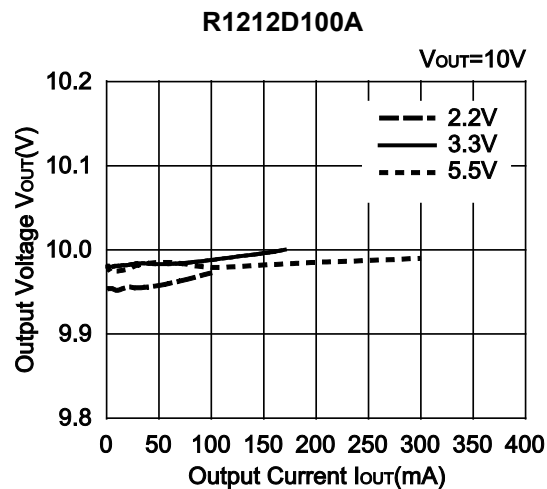
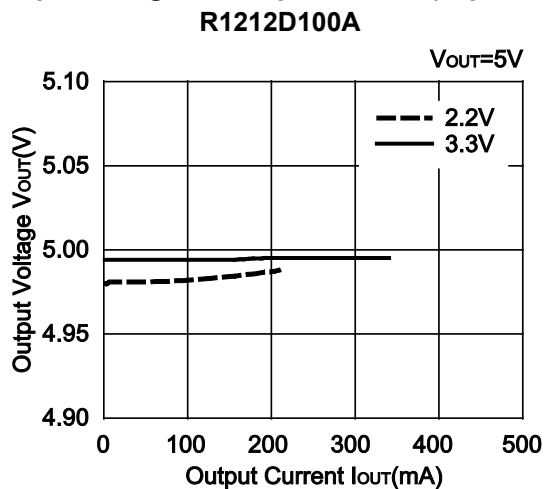

Fig. 12 Output Current vs. Output Voltage/ Efficiency, Response Characteristics Test Circuit

Inductor	VLF504012MT-100M (TDK: 10 $\mu$ H) [R1212DxxxA]					
	VLF504012MT-4R7M (TDK: 4.7 $\mu$ H) [R1212DxxxB]					
	VLF504012MT-220M (TDK: 22 $\mu$ H) [R1212DxxxC]					
NMOS	CPH6415 (Sanyo)					
Diode	CRS10I30A (Toshiba)					
C1	2.2 $\mu$ F	C6	0.1 $\mu$ F			
C2	1 $\mu$ F	C7	0.1 $\mu$ F			
C3	15 $\mu$ F	SetV	5 V	10 V	15 V	
C4	1000 pF [R1212DxxxA]	R1	120 k $\Omega$	180 k $\Omega$	140 k $\Omega$	
	680 pF [R1212DxxxB]	R2	30 k $\Omega$	20 k $\Omega$	10 k $\Omega$	
	1500 pF [R1212DxxxC]	R3	1 k $\Omega$			
C5	1000 pF [R1212DxxxA]	R4	4.7 k $\Omega$			
	680 pF [R1212DxxxB]	R5	240 k $\Omega$			
	1500 pF [R1212DxxxC]	R6	300 k $\Omega$			

## TYPICAL CHARACTERISTICS

1) Output Voltage vs. Output Current (Topt = 25°C)



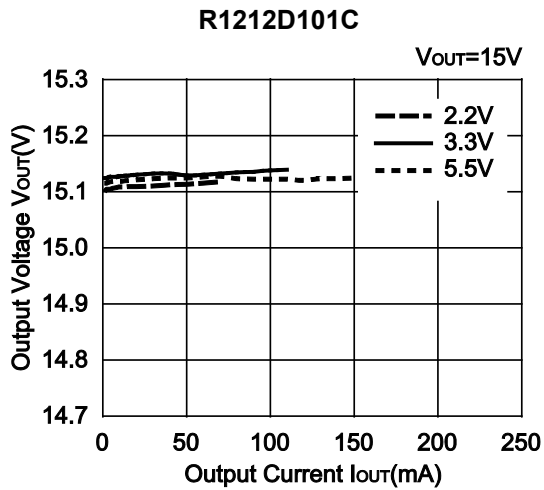
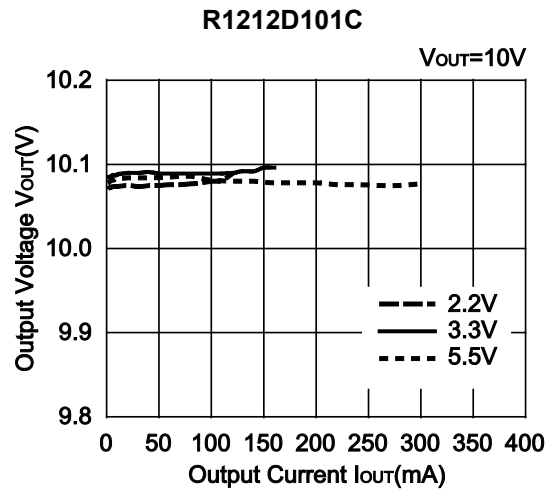
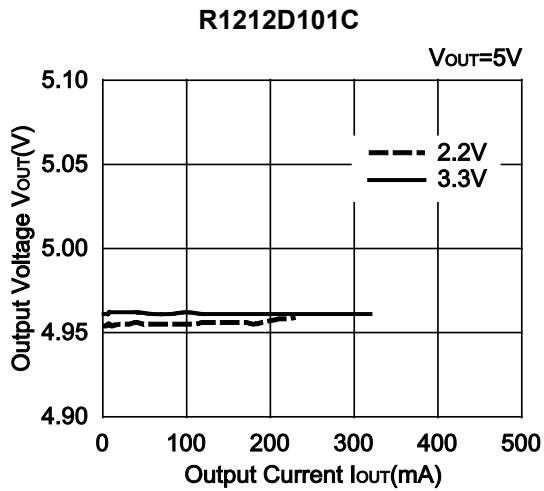

2) Efficiency vs. Output Current ( $T_{opt} = 25^{\circ}C$ )

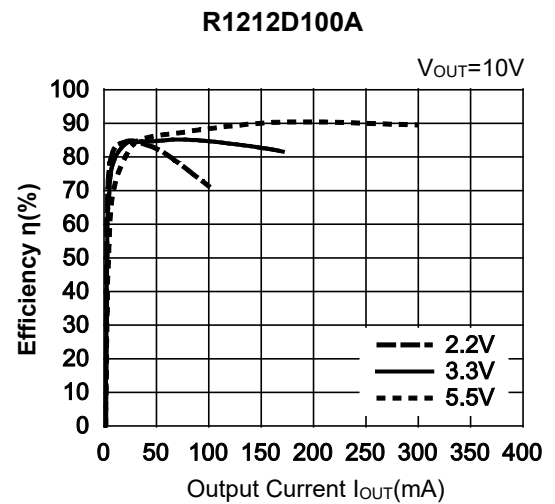
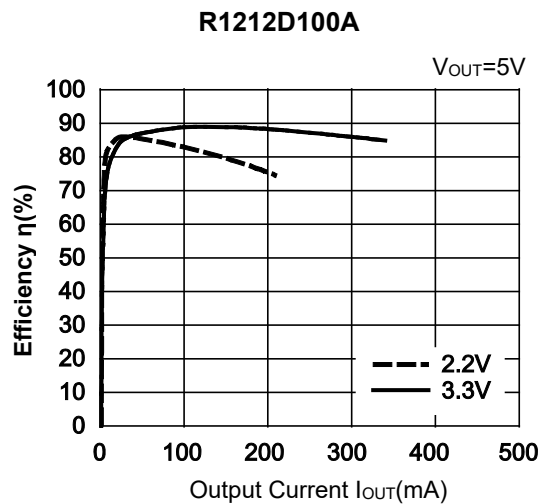

R1212D100A

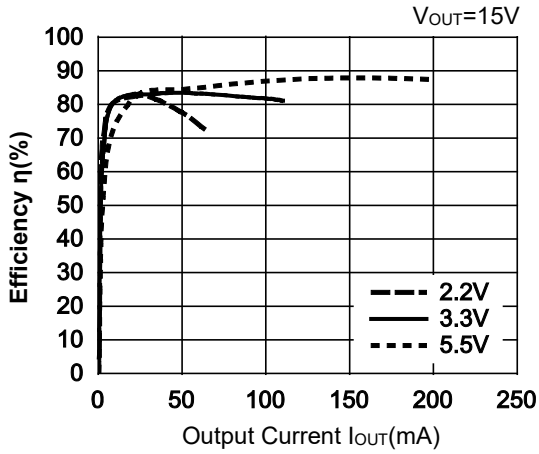

R1212D100B

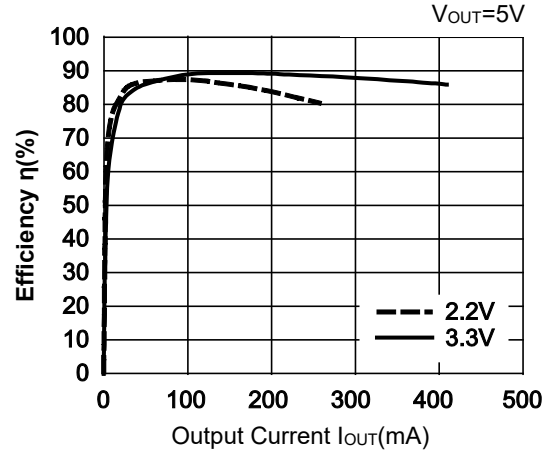

R1212D100B

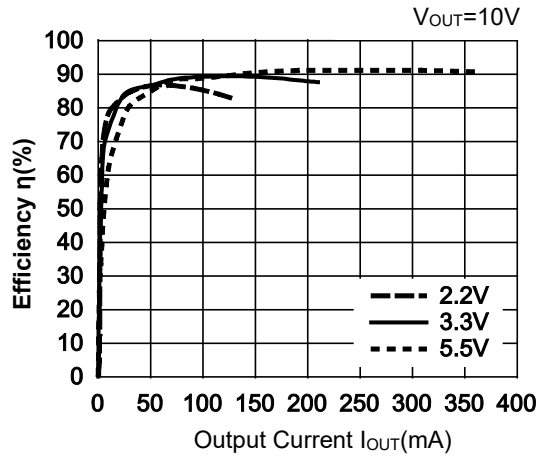

R1212D100B

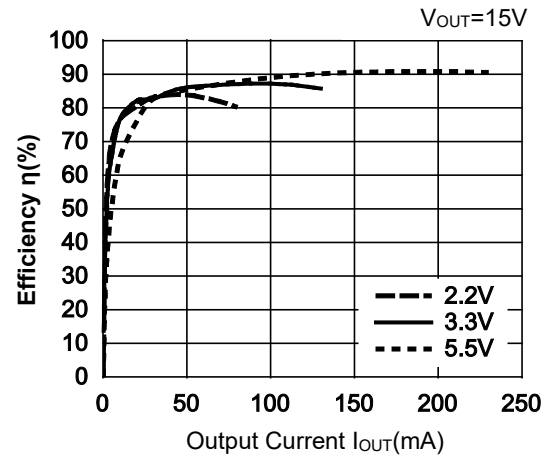

R1212D101C

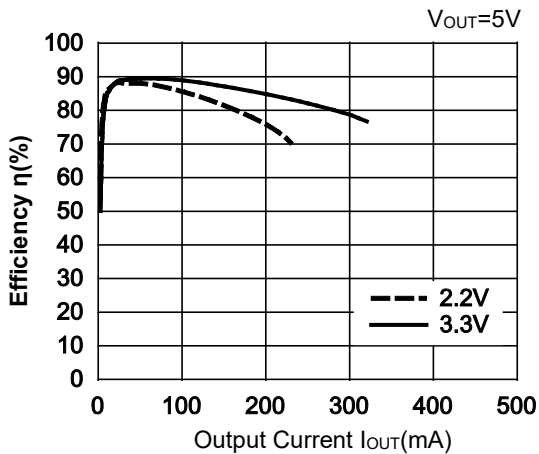

R1212D101C

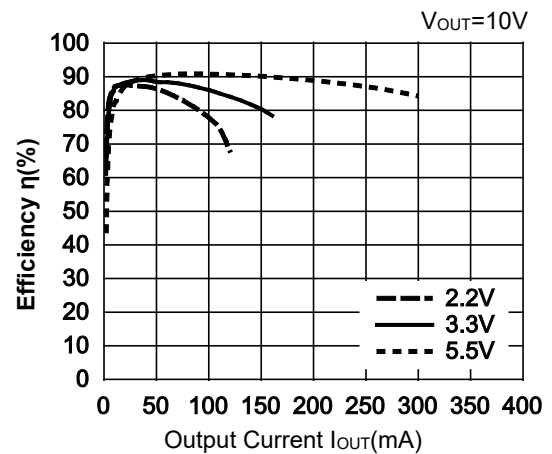



R1212D101C

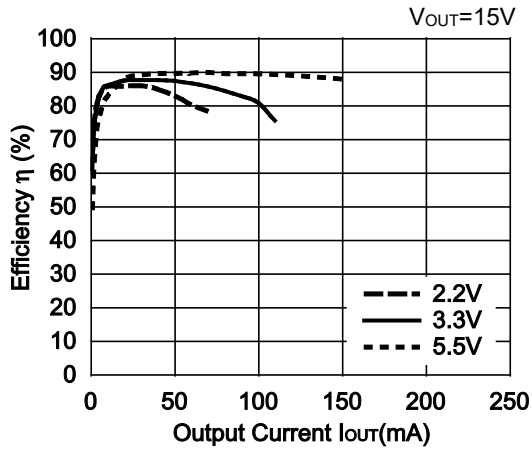

3) VFB Voltage vs. Input Voltage (Topt = 25°C)  
R1212D100x

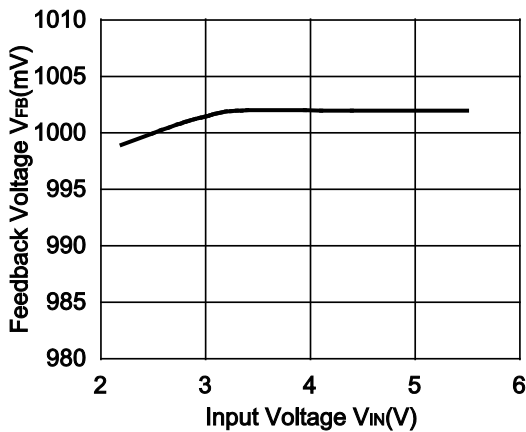

4) VFB Voltage vs. Temperature  
R1212D100x

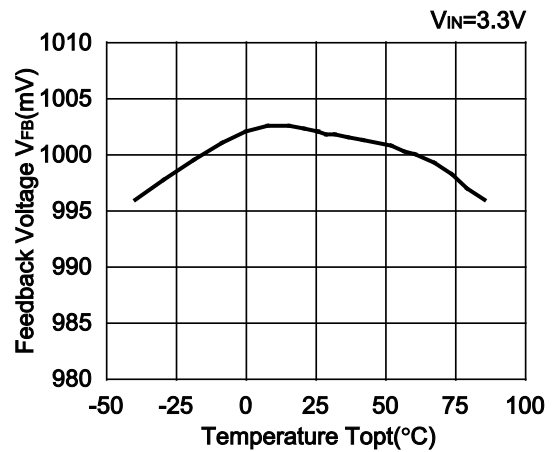

5) Oscillator Frequency vs. Input Voltage (Topt = 25°C)  
R1212D100A

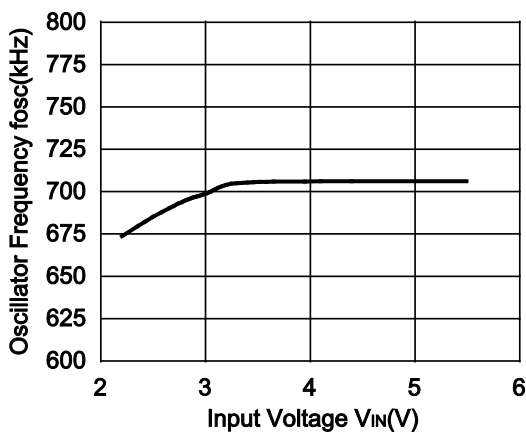

R1212D100B

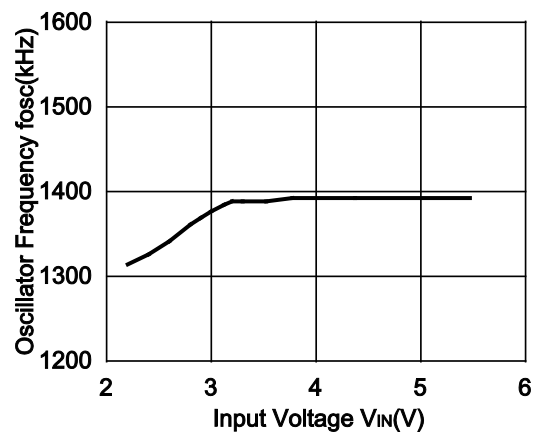

R1212D101C

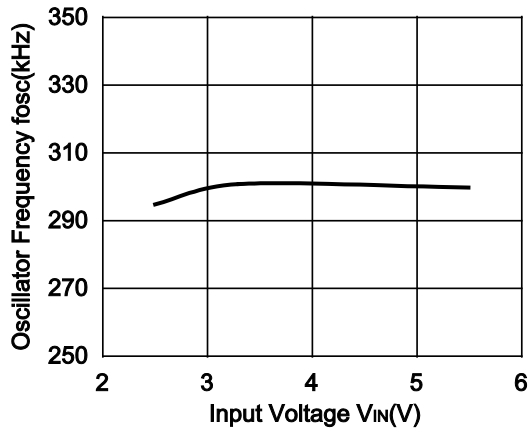

6) Oscillator Frequency vs. Temperature

R1212D10xA

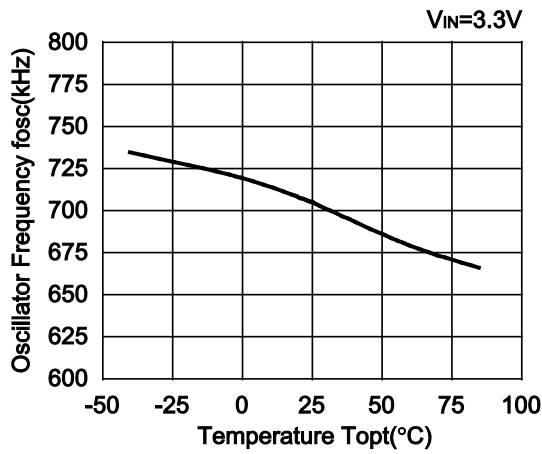

R1212D10xB

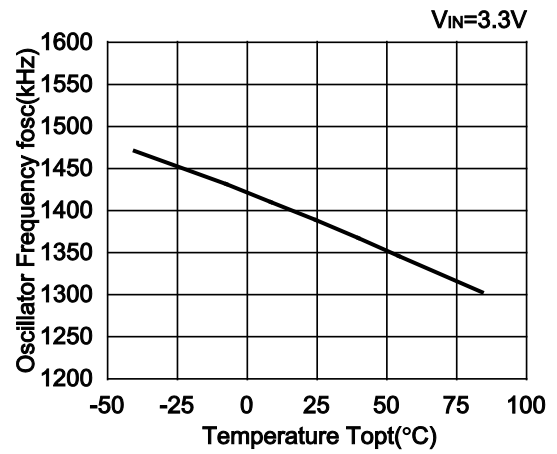

R1212D10xC

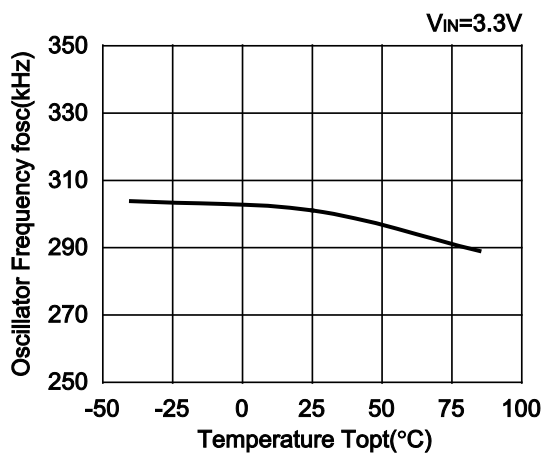

7) Supply Current vs. Input Voltage (Topt = 25°C at no load)

R1212D100A

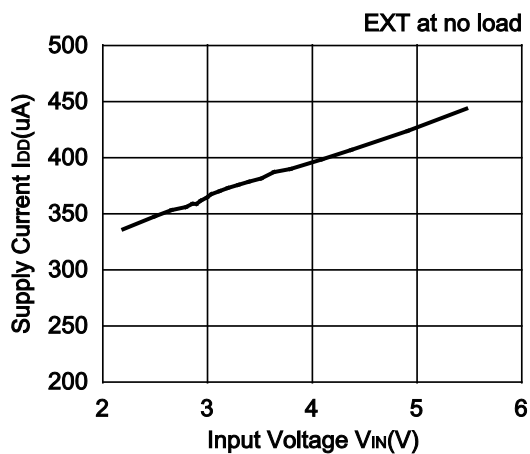

R1212D100B

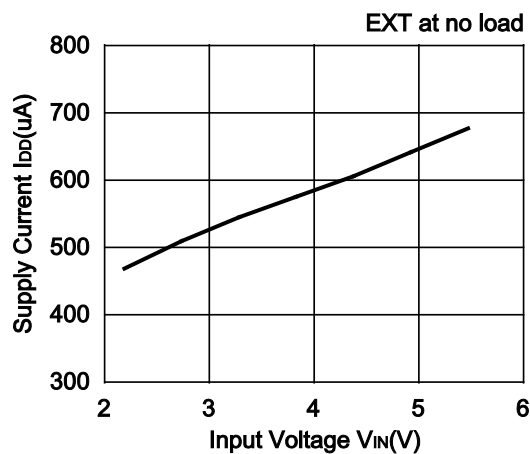

R1212D101C

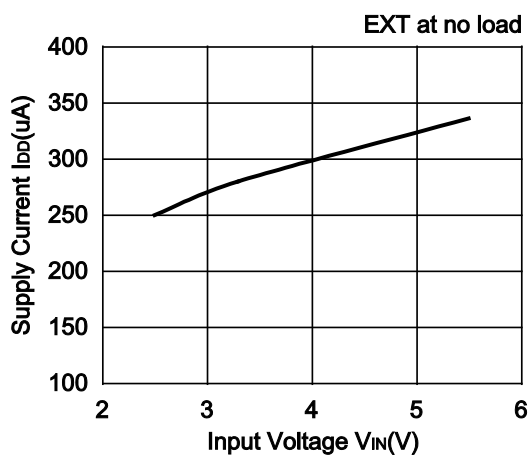

8) Supply Current vs. Temperature

R1212D10xA

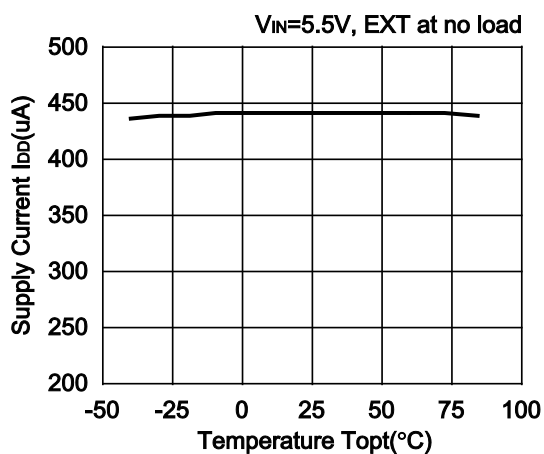

R1212D10xB

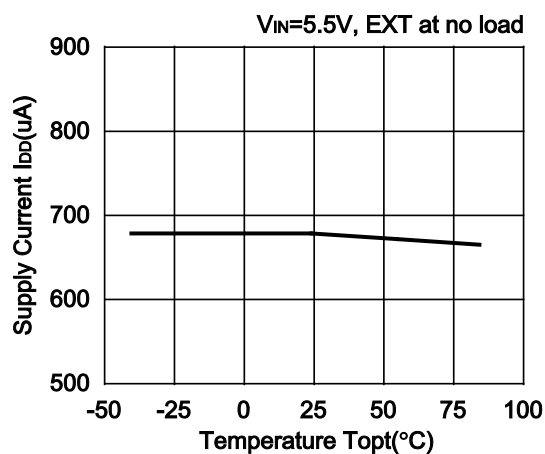

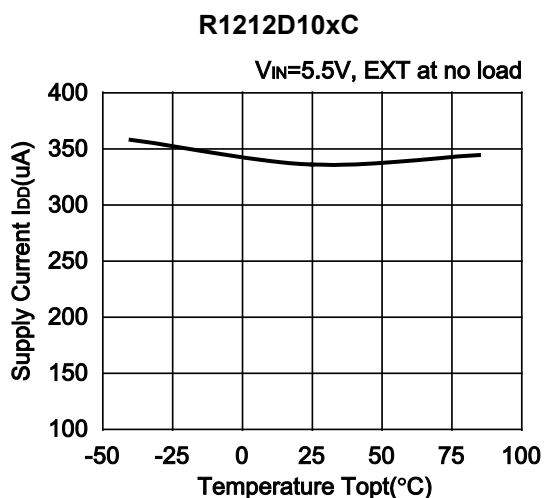

9) EXT "L" On Resistance vs. Temperature  
R1212D10xx

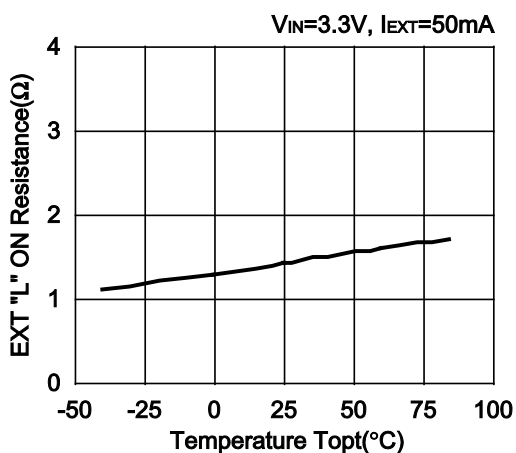

11) EXT Rising Time vs. Temperature  
R1212D10xx

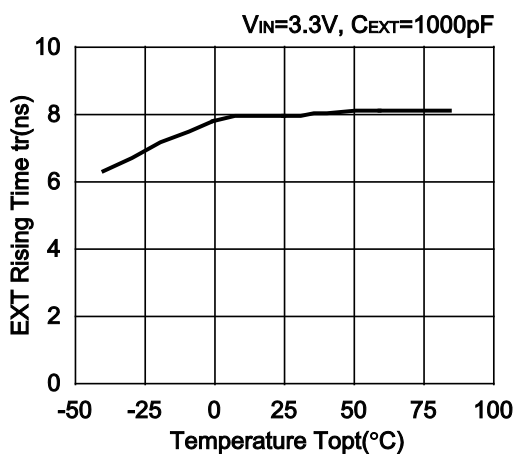

10) EXT "H" On Resistance vs. Temperature  
R1212D10xx

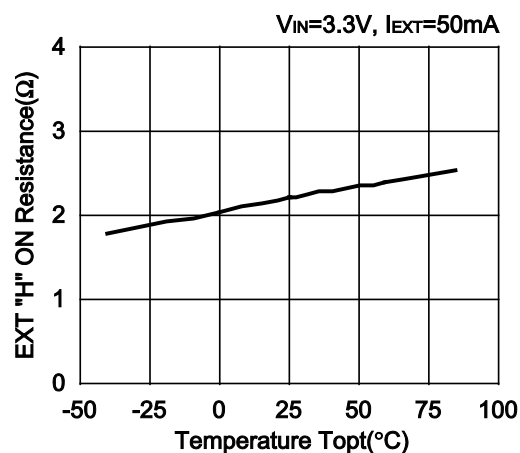

12) EXT Falling Time vs. Temperature  
R1212D10xx

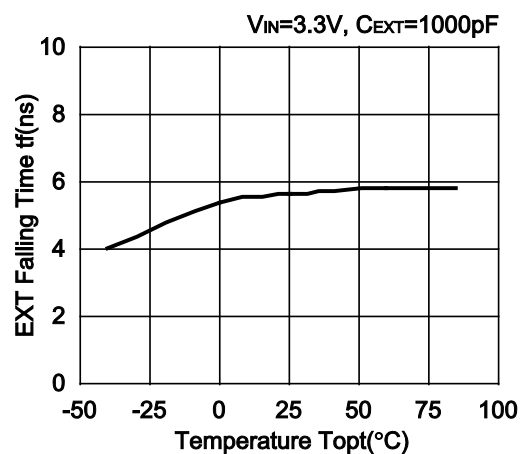

13) Duty Cycle vs. DTC Voltage (0% to 100%) (Topt = 25°C)

R1212D100A

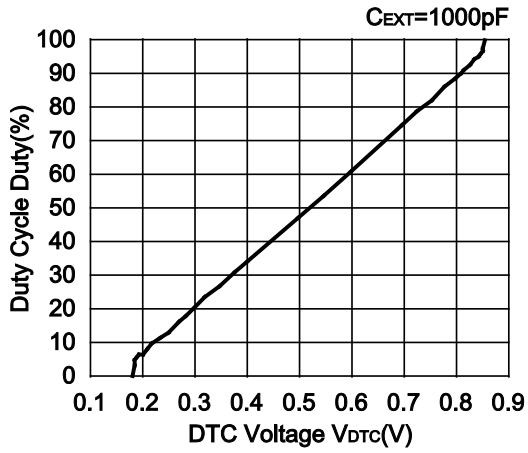

R1212D100B

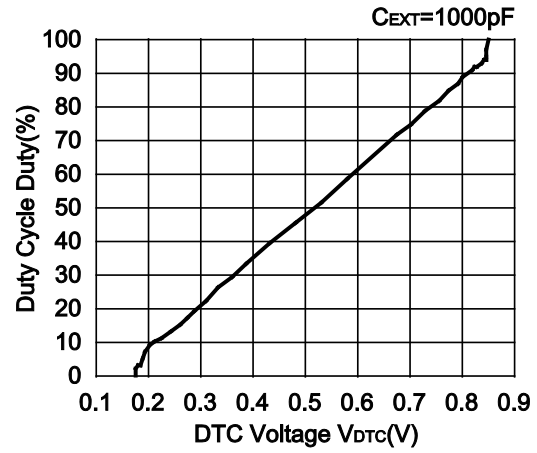

R1212D101A

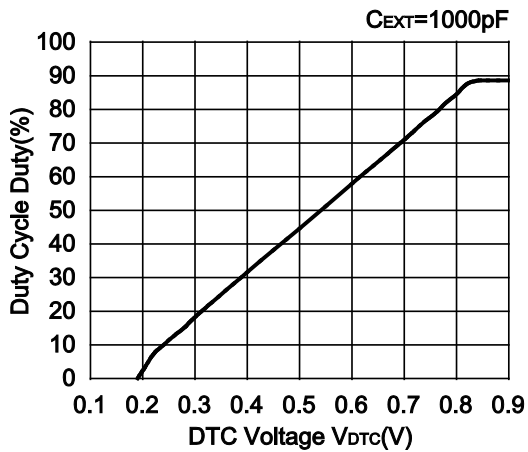

R1212D101C

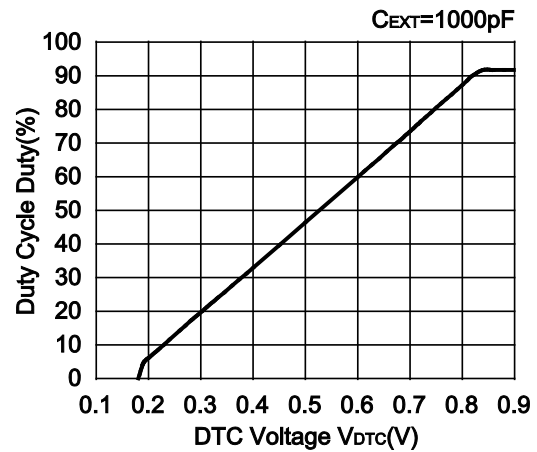

14) Duty Cycle vs. Temperature

R1212D100A

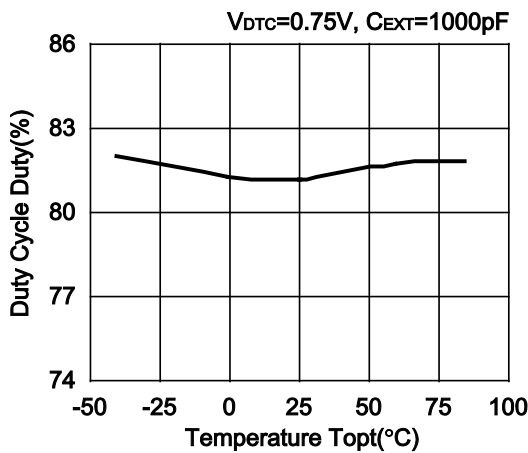

R1212D100B

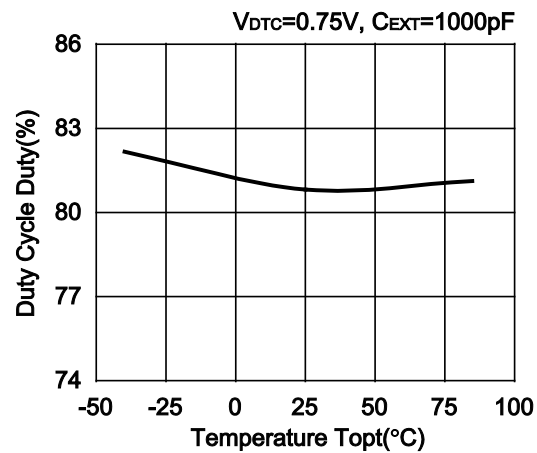

15) Maxduty vs. Temperature

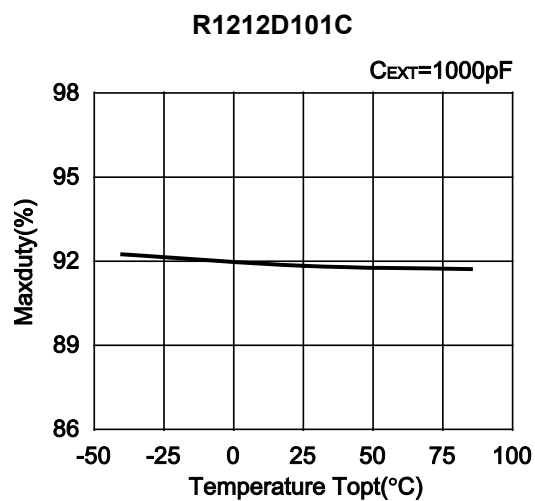
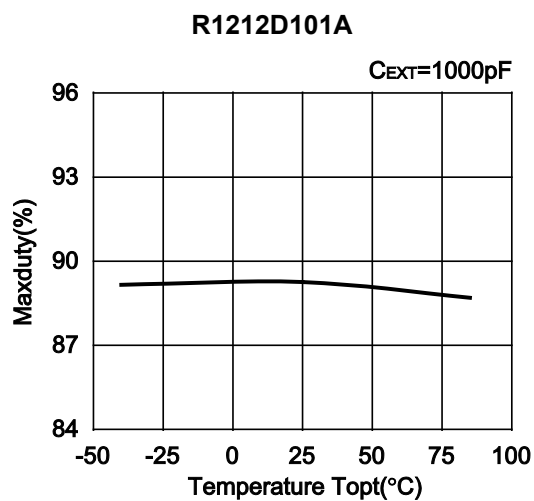

16) AMP "L" Output Current vs. Temperature

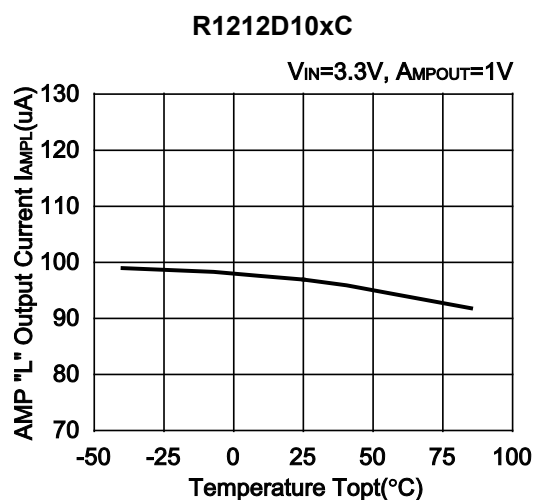
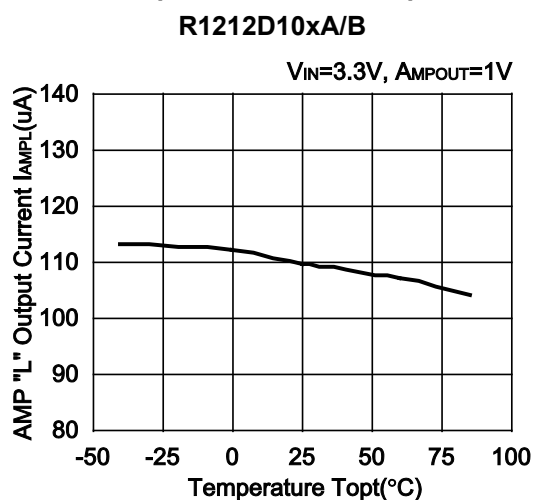

17) AMP "H" Output Current vs. Temperature

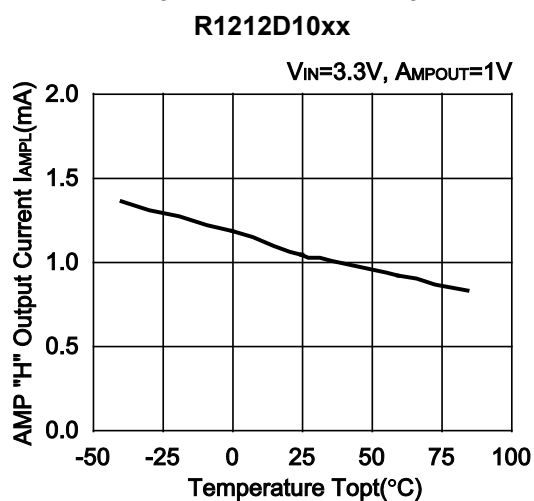

18) UVLO Detector Threshold UVLO Released Voltage vs. Temperature

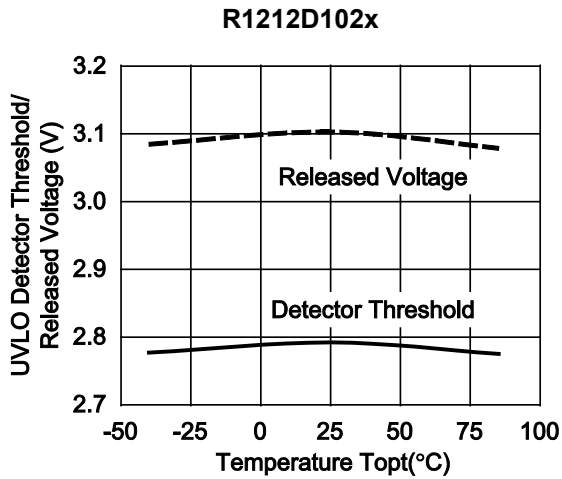
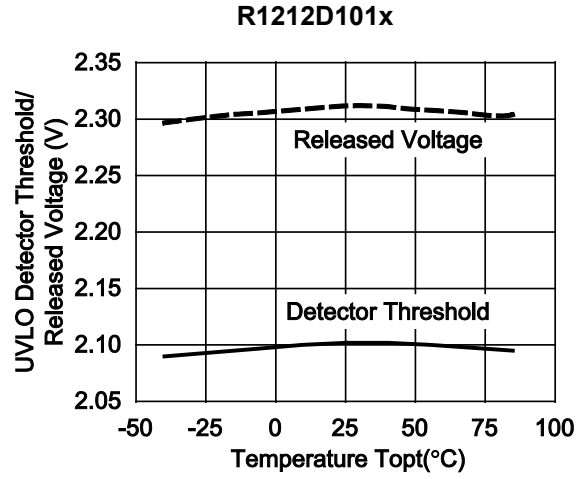
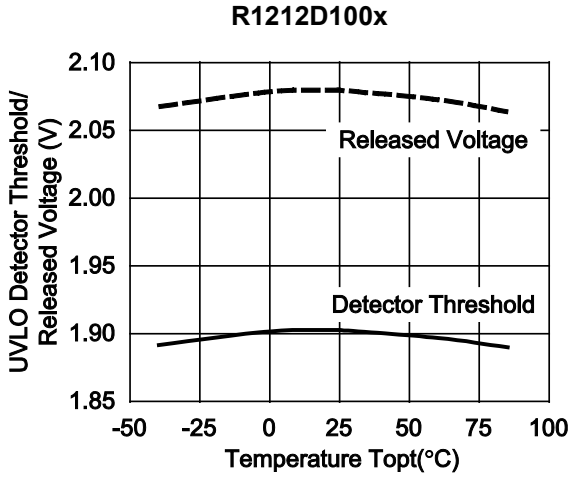

19) DELAY Pin Detector Threshold vs. Temperature

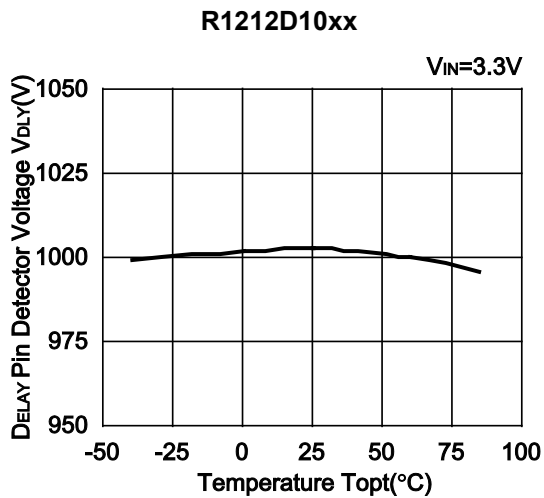

20) DELAY Pin Charge Current vs. Temperature

R1212D10xA/B

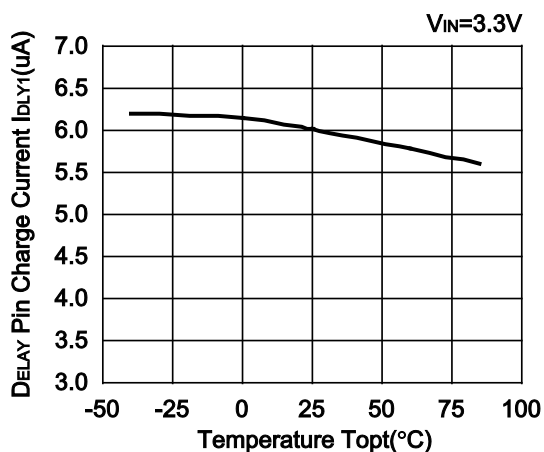

R1212D10xC

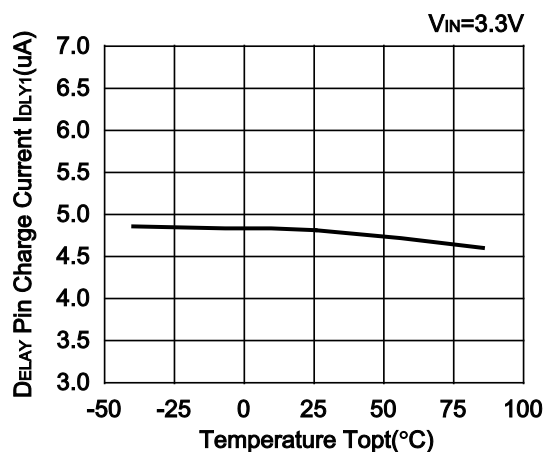

21) DELAY Pin Discharge Current vs. Temperature

R1212D10xx

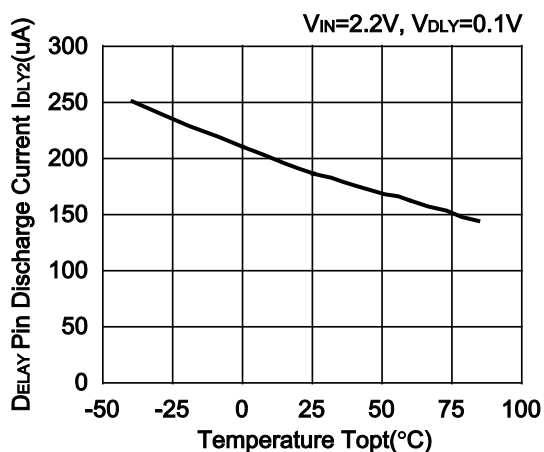

22) VREFOUT Voltage vs. Temperature

R1212D10xx

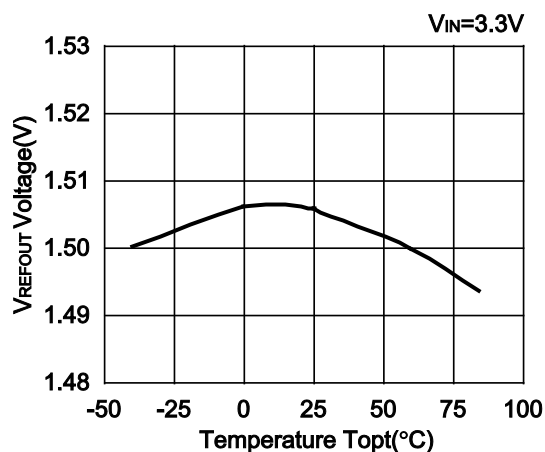

23) VREFOUT Voltage vs. Input Voltage (T<sub>opt</sub> = 25°C)

R1212D10xx

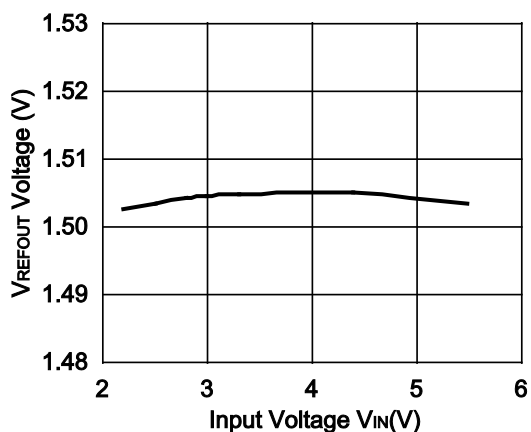

24) VREFOUT Voltage vs. Output Current (1) (T<sub>opt</sub> = 25°C)

R1212D100x

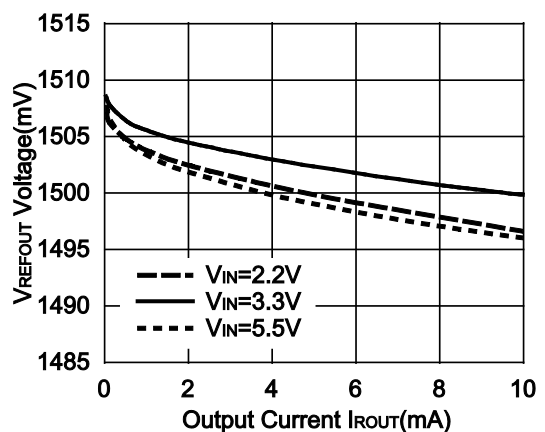



25) VREFOUT Voltage vs. Output Current (2) (Topt = 25°C) 26) Error Amplifier Gain/Phase vs. Frequency (Topt = 25°C)

R1212D100x

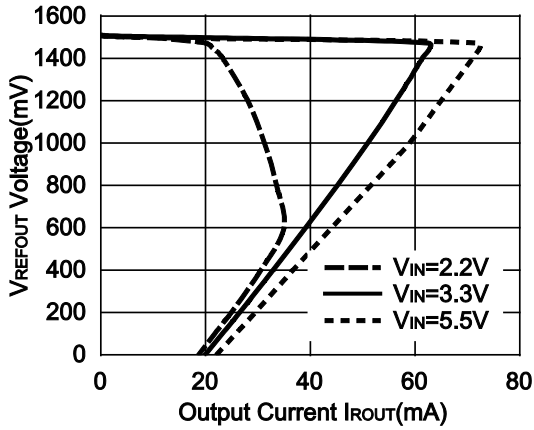

R1212D100xx

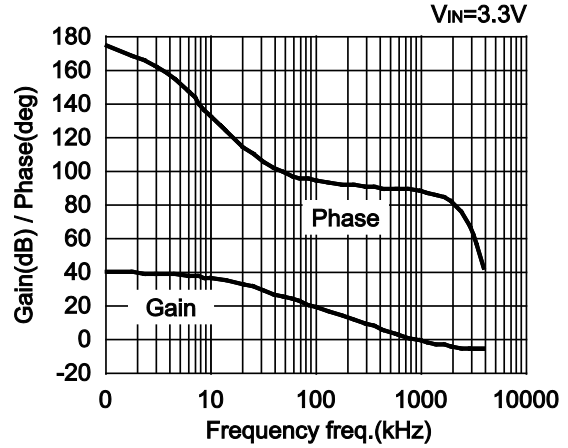

27) Power-on Response (VIN = 3.3 V, Topt = 25°C)

R1212D100A

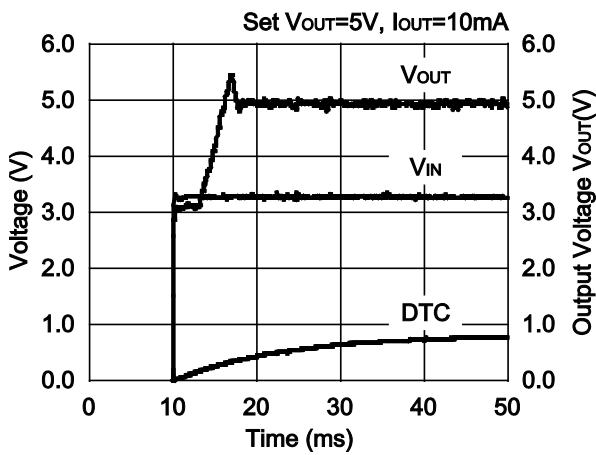

R1212D100A

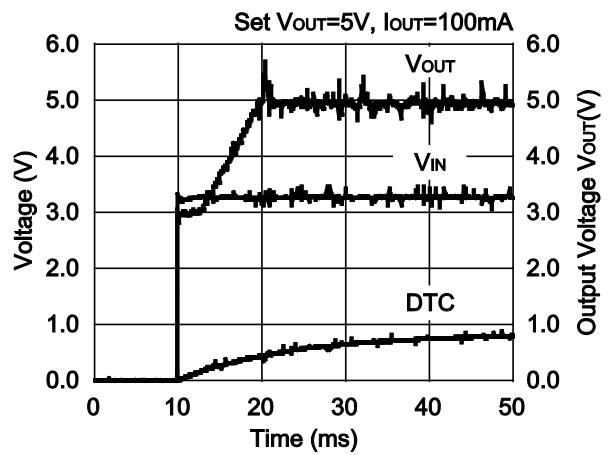

R1212D100A

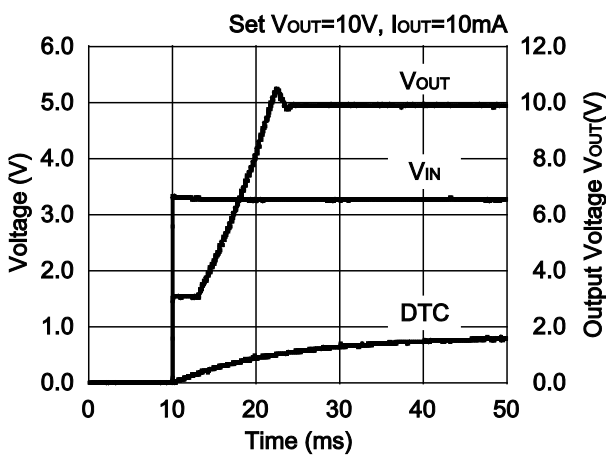

R1212D100A

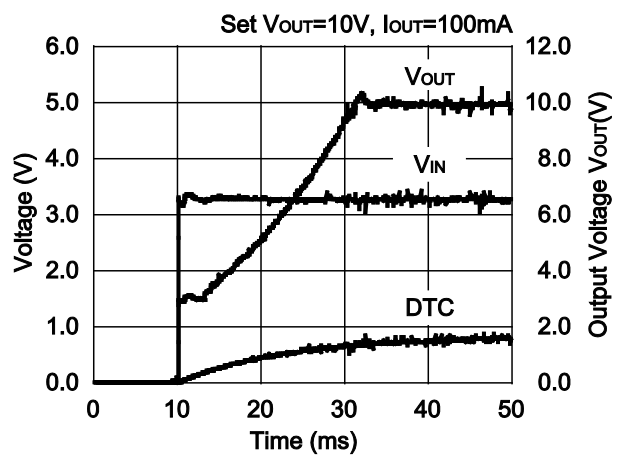

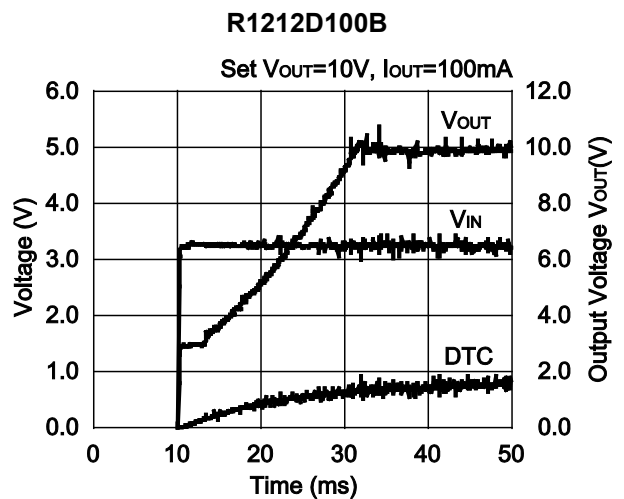
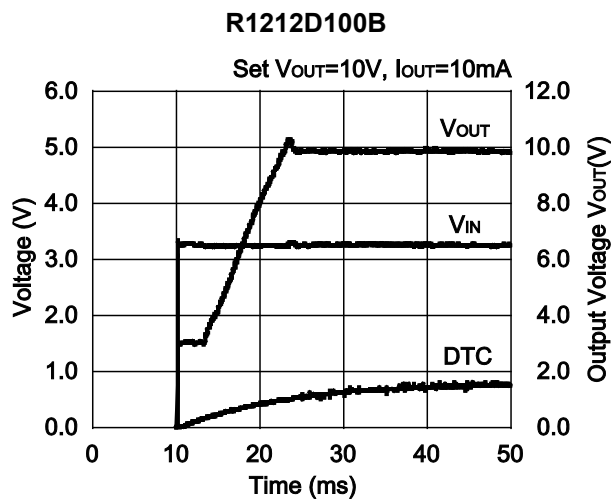
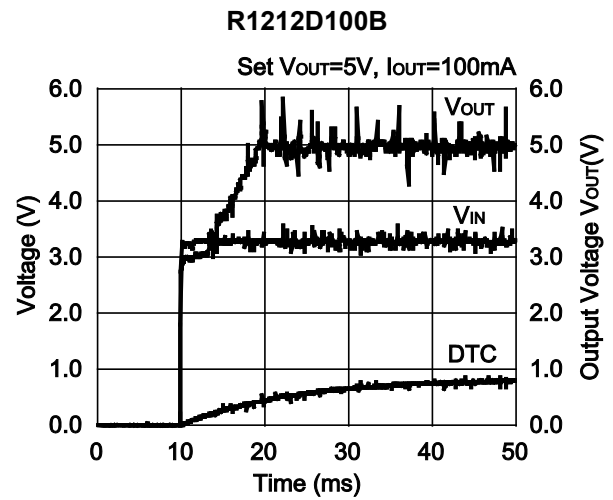
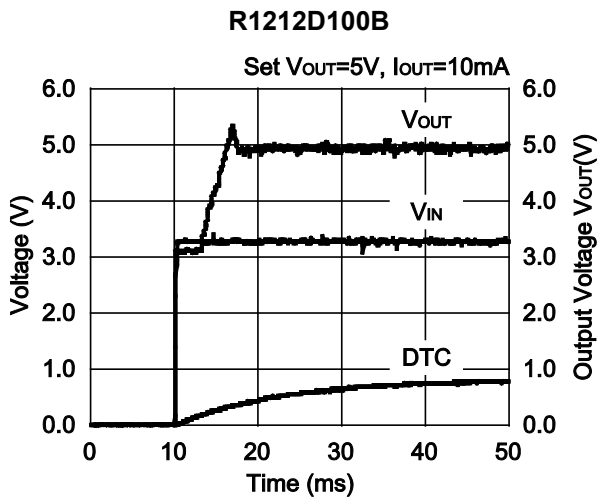
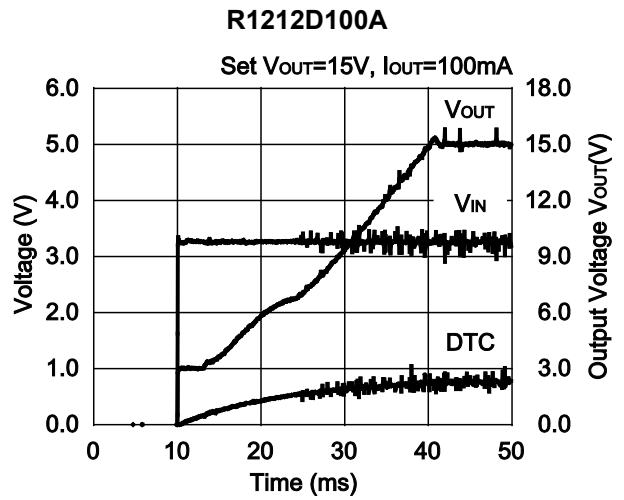
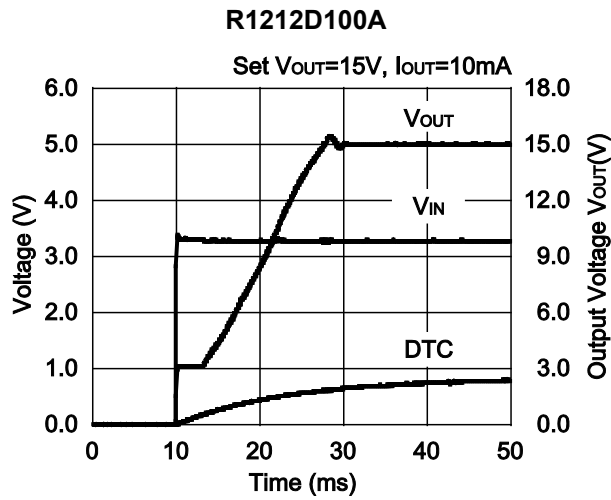

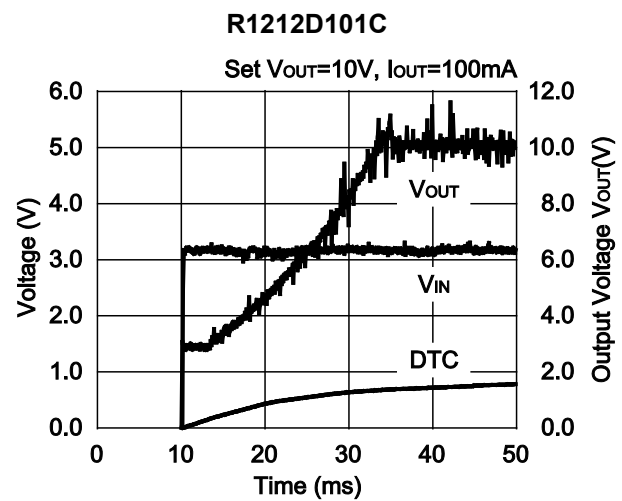
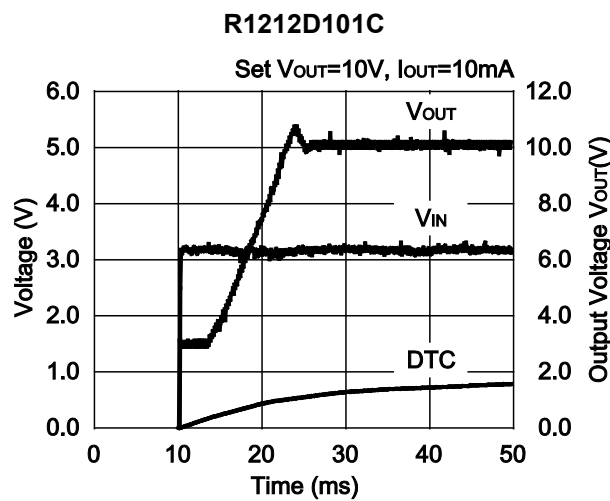
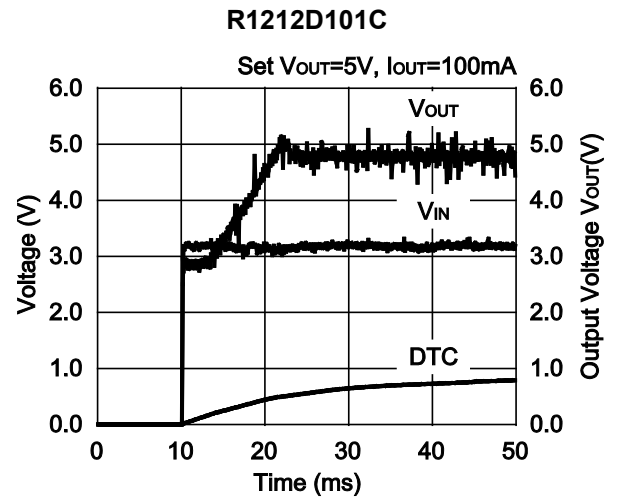
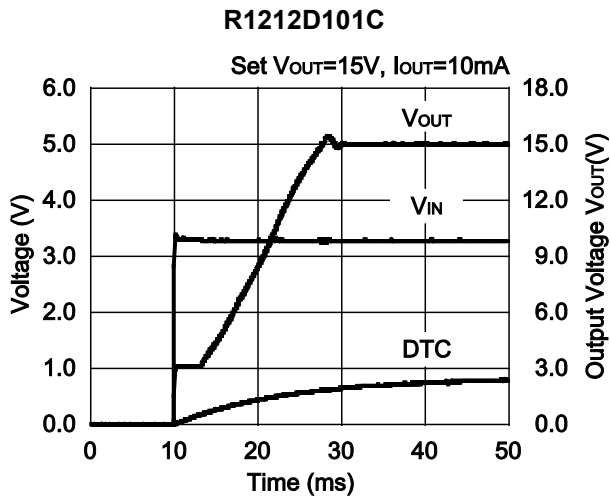
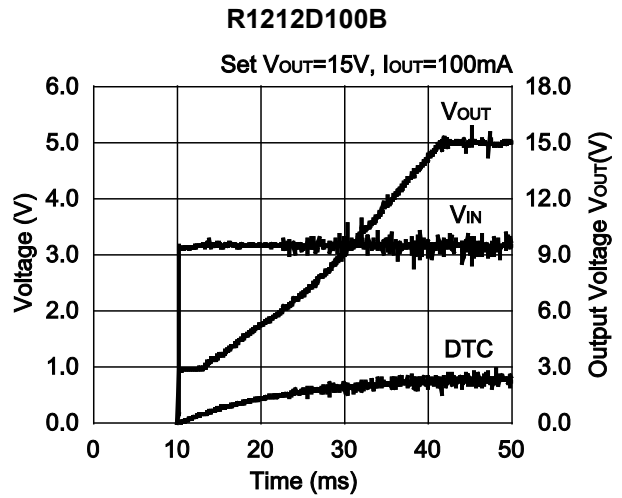
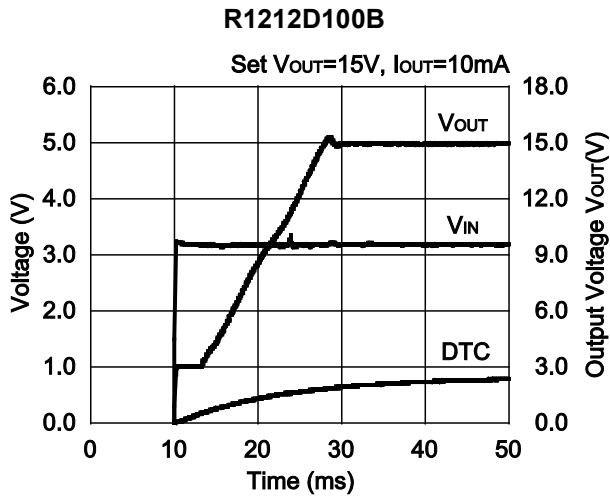

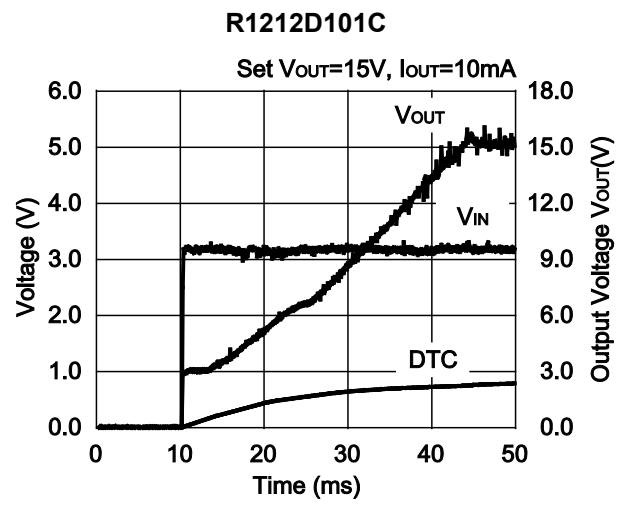
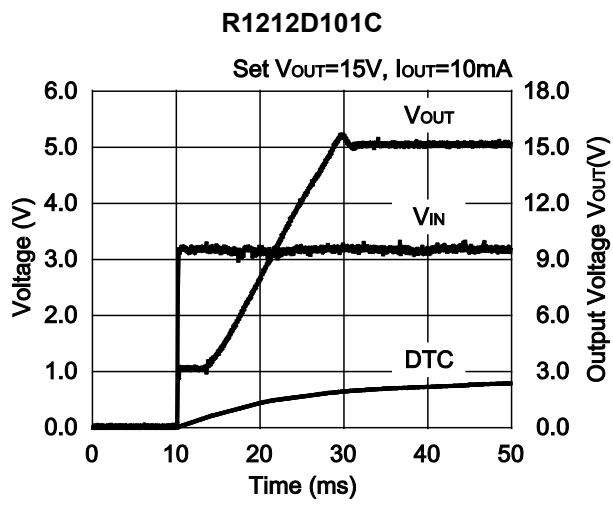

28) Load Transient Response ( $V_{IN} = 3.3\text{ V}$ ,  $T_{opt} = 25^{\circ}\text{C}$ )

R1212D100A

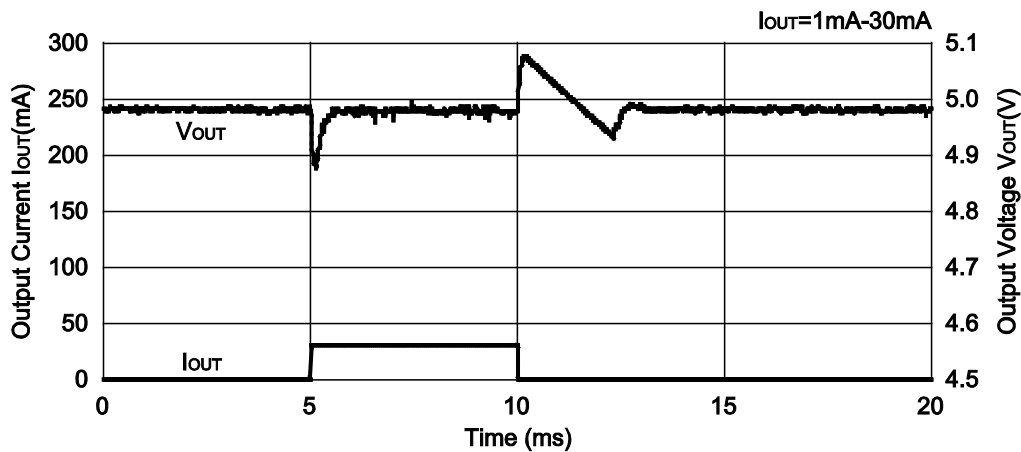

R1212D100A

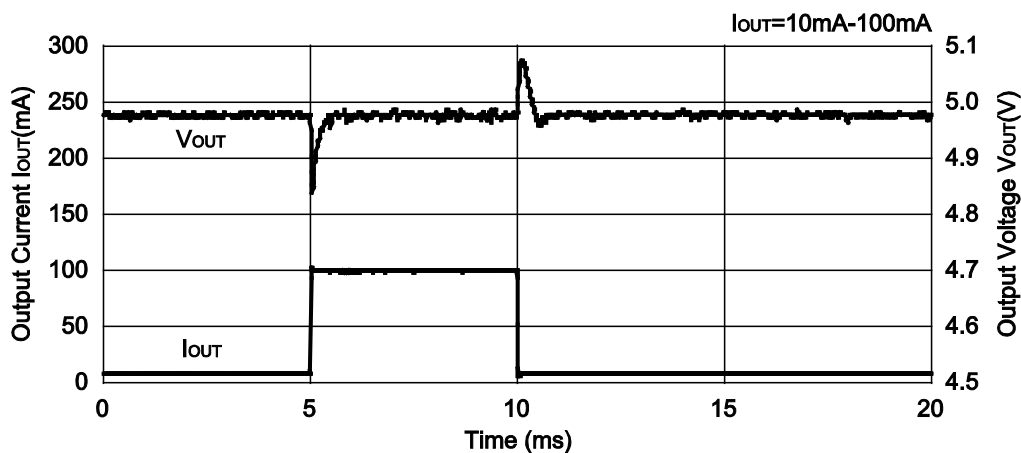

R1212D100A

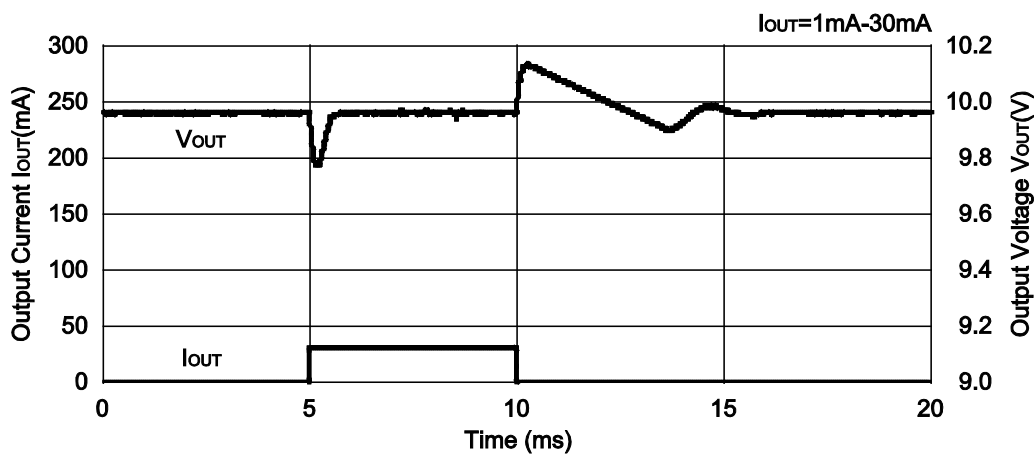

R1212D100A

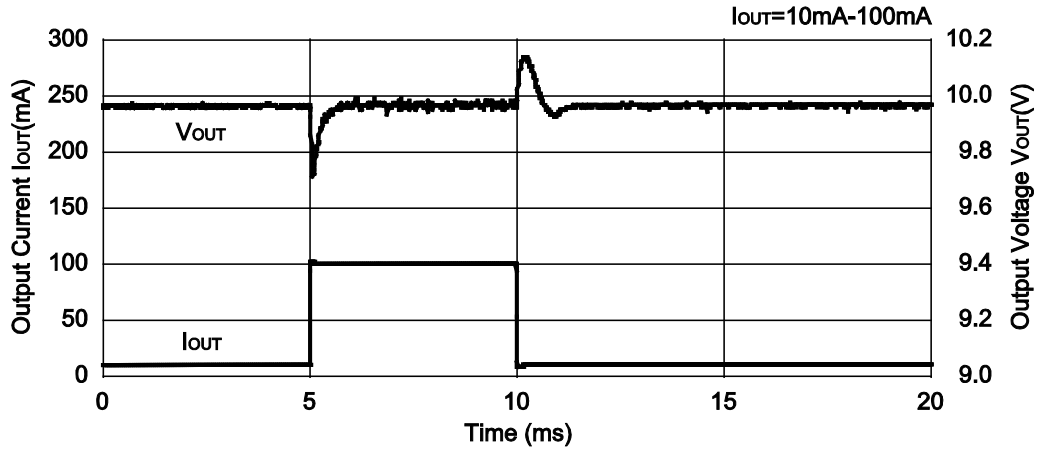

R1212D100A

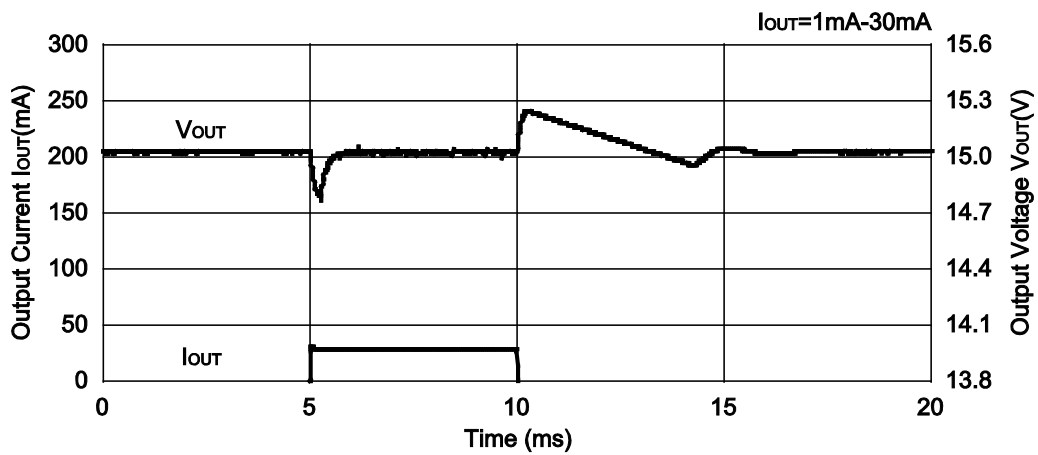

R1212D100A

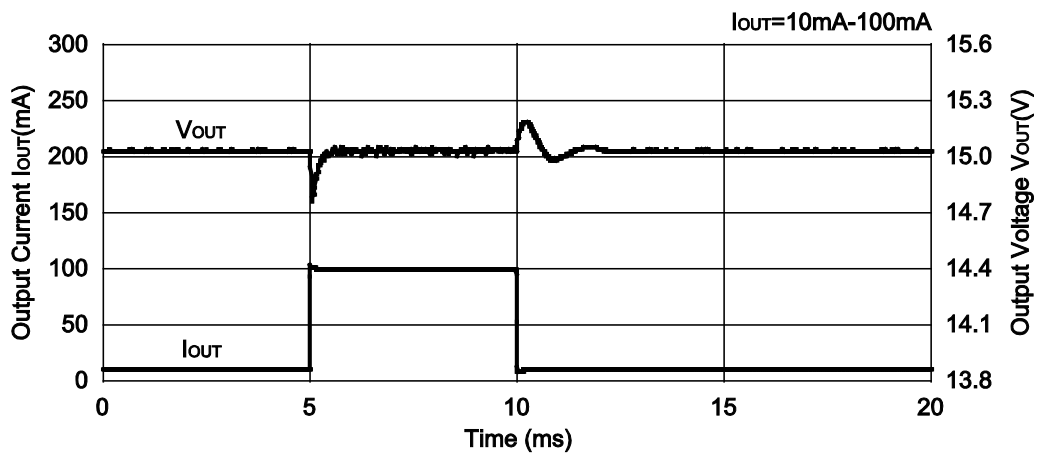

R1212D100A

R1212D100B

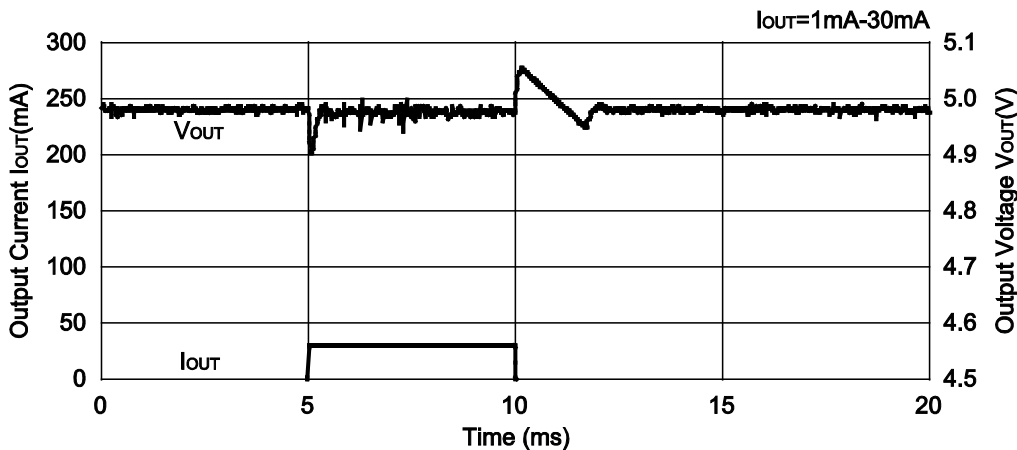

R1212D100B

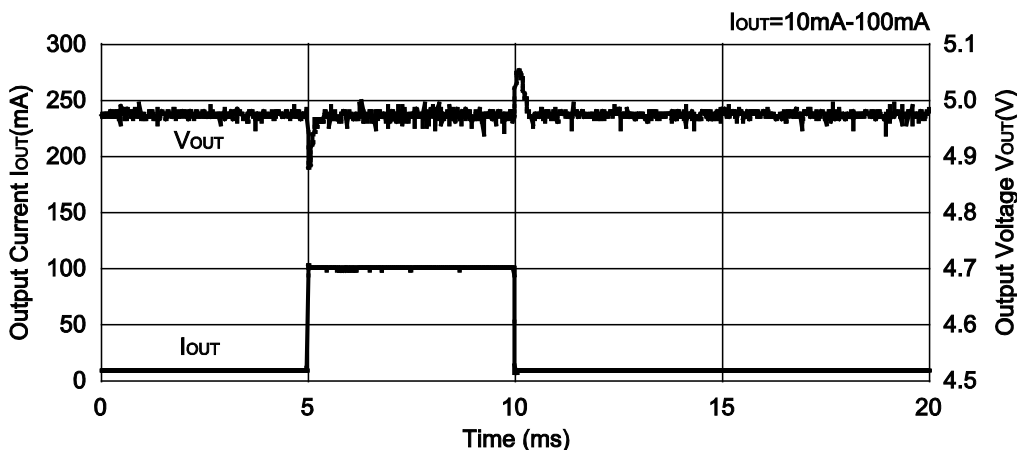

R1212D100B

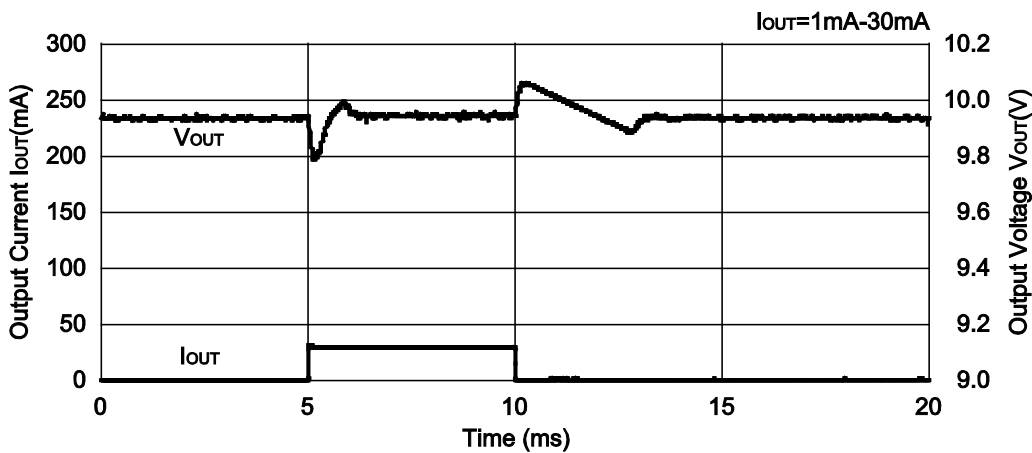

R1212D100B

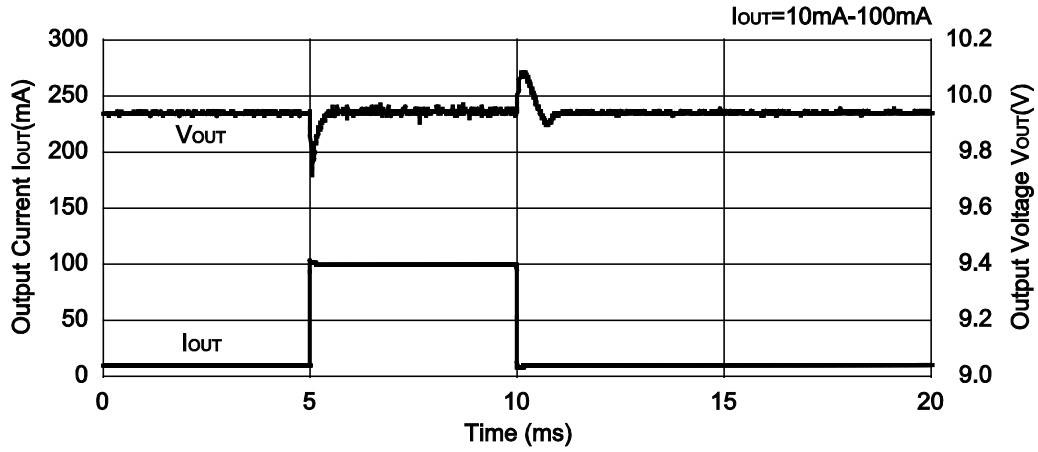

R1212D100B

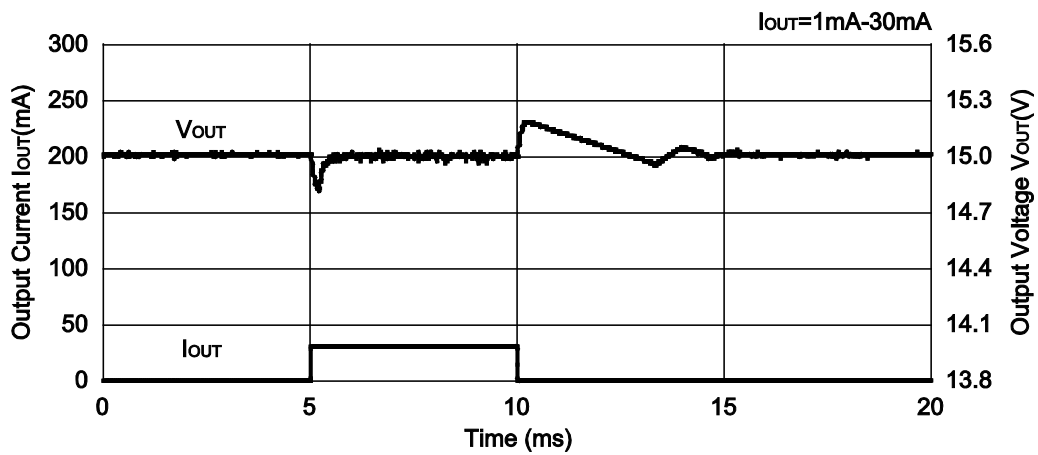

R1212D100B

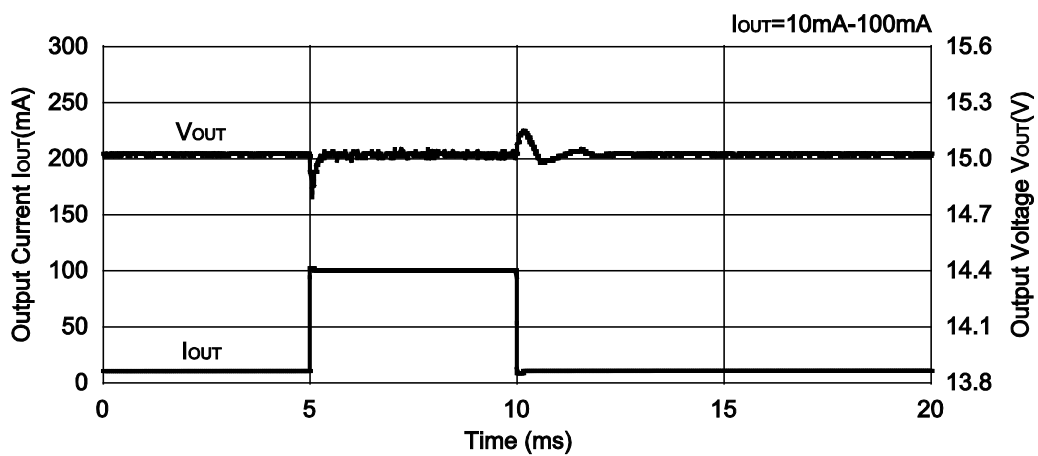



R1212D101C

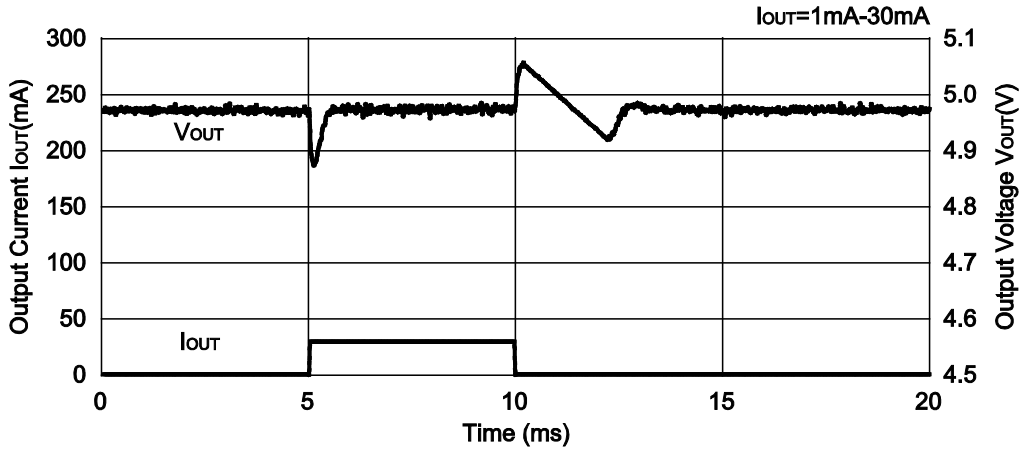

R1212D101C

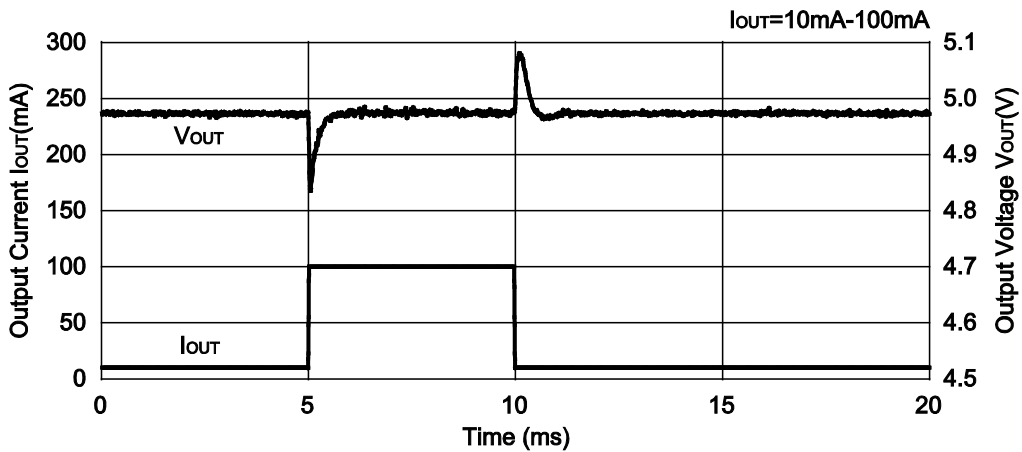

R1212D101C

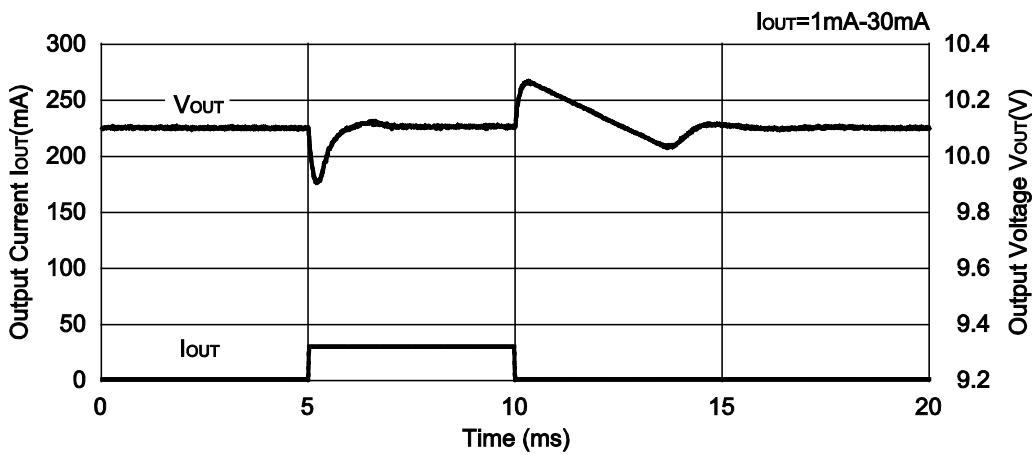

R1212D101C

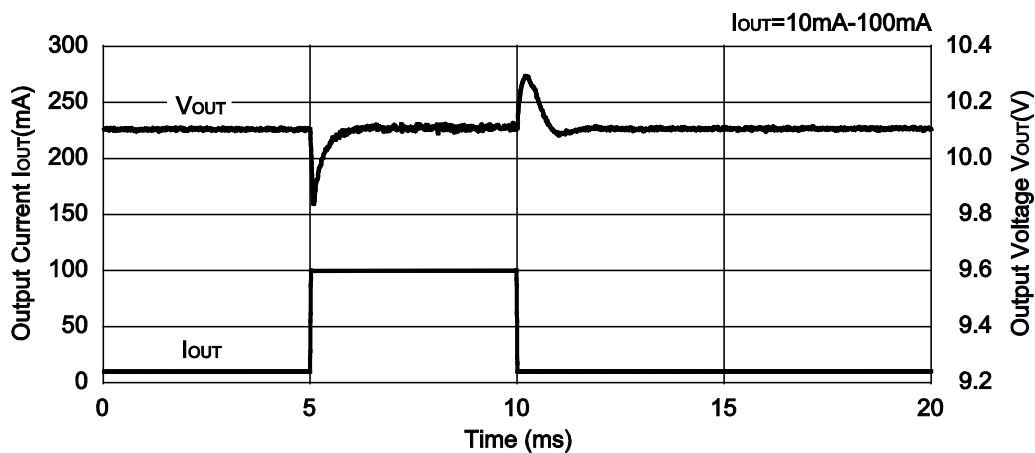

R1212D101C

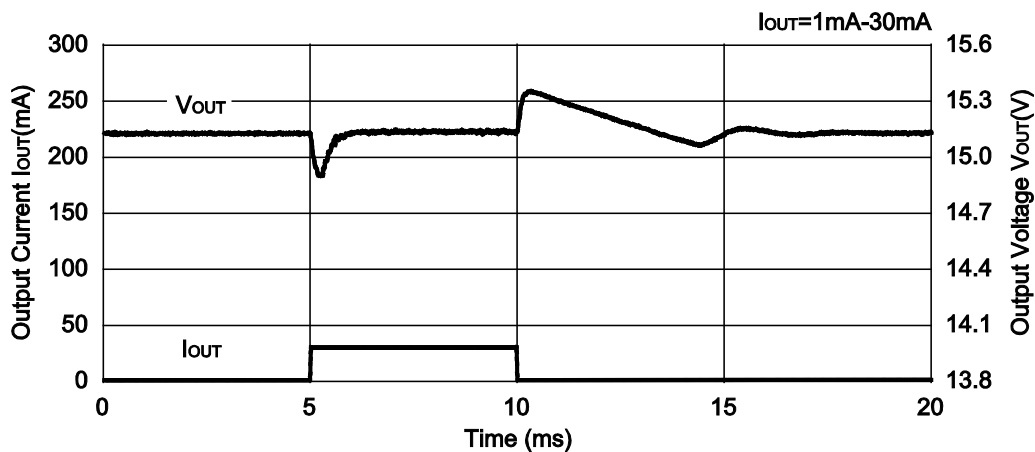

R1212D101C

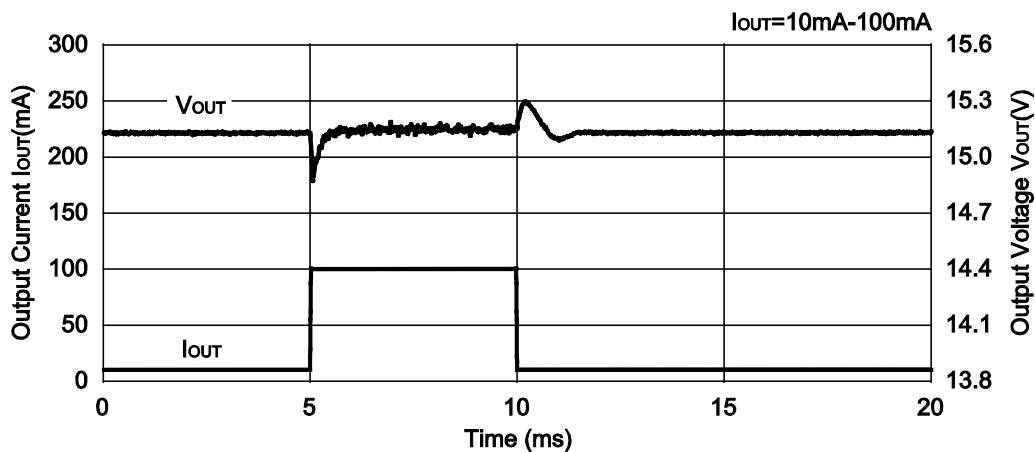

## POWER DISSIPATION

The power dissipation of the package is dependent on PCB material, layout, and environmental conditions. The following conditions are used in this measurement.

### Measurement Conditions

	Standard Test Land Pattern
Environment	Mounting on Board (Wind Velocity = 0 m/s)
Board Material	Glass Cloth Epoxy Plastic (Double-Sided Board)
Board Dimensions	40 mm × 40 mm × 1.6 mm
Copper Ratio	Top Side: Approx. 50% Bottom Side: Approx. 50%
Through-holes	φ 0.5 mm × 44 pcs

### Measurement Result

(Ta = 25°C, Tjmax = 125°C)

	Standard Test Land Pattern	Free Air
Power Dissipation	480 mW	300 mW
Thermal Resistance	$\theta_{ja} = (125 - 25^\circ\text{C}) / 0.48 \text{ W} = 208^\circ\text{C/W}$	333°C/W

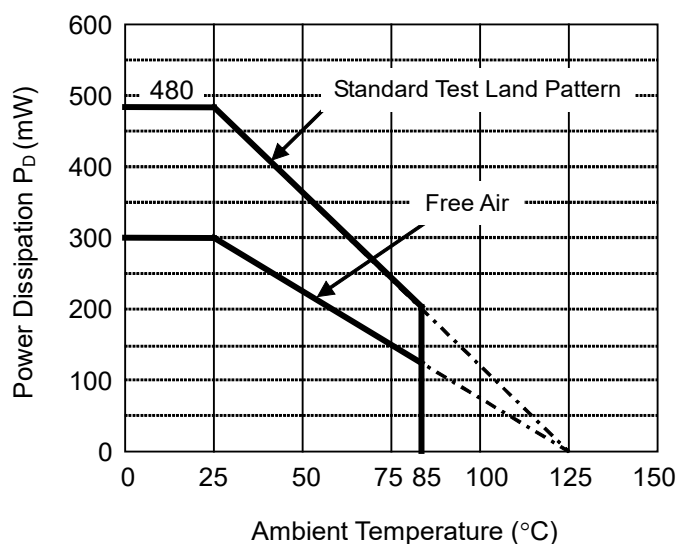

Power Dissipation vs. Ambient Temperature

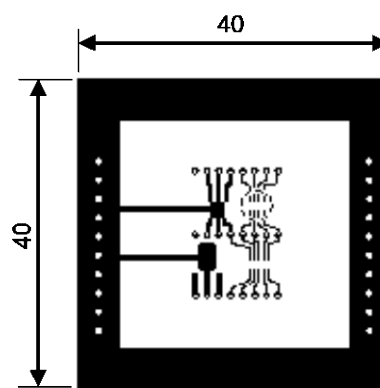

○ IC Mount Area (mm)

Measurement Board Pattern

## PACKAGE DIMENSIONS

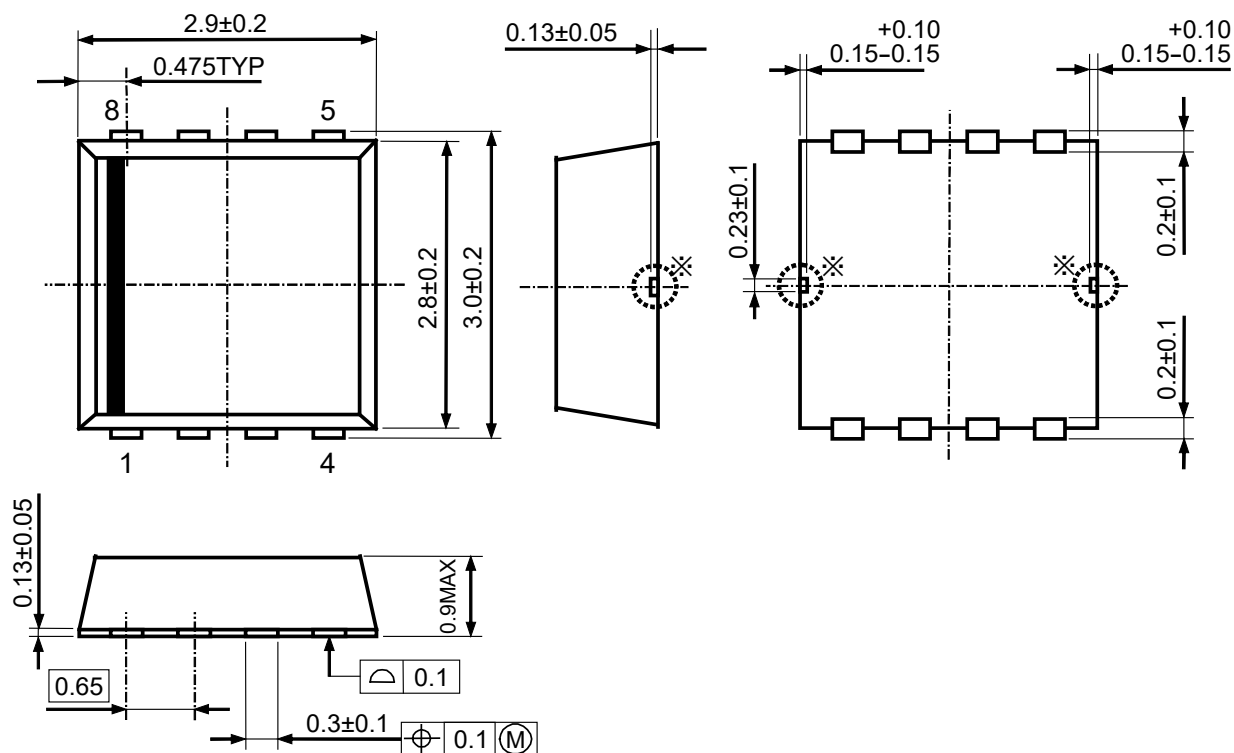

SON-8-18 Package Dimensions (Unit: mm)

\* The tab suspension leads on the bottom of the package is substrate level (GND/  $V_{DD}$ ). It is recommended that the tab suspension leads be connected to the ground plane / the  $V_{DD}$  pin on the board, or otherwise be left floating. Also, the tab suspension leads should not connect to other wires or land patterns.

## PART MARKINGS

①②③④: Product Code ... Refer to *Part Marking List*

⑤⑥: Lot Number ... Alphanumeric Serial Number

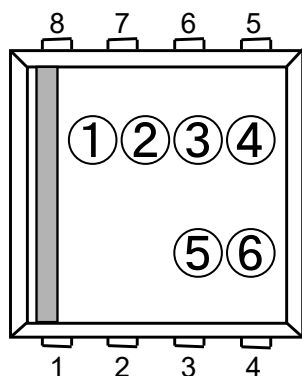

### • Part Marking List

Product Name	①②③④	⑤⑥
R1212D100A	F10A	Lot No.
R1212D100B	F10B	Lot No.
R1212D101A	F11A	Lot No.
R1212D101C	F11C	Lot No.
R1212D102A	F12A	Lot No.
R1212D102C	F12C	Lot No.

### NOTICE

There can be variation in the marking when different AOI (Automated Optical Inspection) equipment is used. In the case of recognizing the marking characteristic with AOI, please contact our sales or distributor before attempting to use AOI.

1. The products and the product specifications described in this document are subject to change or discontinuation of production without notice for reasons such as improvement. Therefore, before deciding to use the products, please refer to our sales representatives for the latest information thereon.
2. The materials in this document may not be copied or otherwise reproduced in whole or in part without the prior written consent of us.
3. This product and any technical information relating thereto are subject to complementary export controls (so-called KNOW controls) under the Foreign Exchange and Foreign Trade Law, and related politics ministerial ordinance of the law. (Note that the complementary export controls are inapplicable to any application-specific products, except rockets and pilotless aircraft, that are insusceptible to design or program changes.) Accordingly, when exporting or carrying abroad this product, follow the Foreign Exchange and Foreign Trade Control Law and its related regulations with respect to the complementary export controls.
4. The technical information described in this document shows typical characteristics and example application circuits for the products. The release of such information is not to be construed as a warranty of or a grant of license under our or any third party's intellectual property rights or any other rights.
5. The products listed in this document are intended and designed for use as general electronic components in standard applications (office equipment, telecommunication equipment, measuring instruments, consumer electronic products, amusement equipment etc.). Those customers intending to use a product in an application requiring extreme quality and reliability, for example, in a highly specific application where the failure or misoperation of the product could result in human injury or death should first contact us.
  - Aerospace Equipment
  - Equipment Used in the Deep Sea
  - Power Generator Control Equipment (nuclear, steam, hydraulic, etc.)
  - Life Maintenance Medical Equipment
  - Fire Alarms / Intruder Detectors
  - Vehicle Control Equipment (automotive, airplane, railroad, ship, etc.)
  - Various Safety Devices
  - Traffic control system
  - Combustion equipment

In case your company desires to use this product for any applications other than general electronic equipment mentioned above, make sure to contact our company in advance. Note that the important requirements mentioned in this section are not applicable to cases where operation requirements such as application conditions are confirmed by our company in writing after consultation with your company.

6. We are making our continuous effort to improve the quality and reliability of our products, but semiconductor products are likely to fail with certain probability. In order to prevent any injury to persons or damages to property resulting from such failure, customers should be careful enough to incorporate safety measures in their design, such as redundancy feature, fire containment feature and fail-safe feature. We do not assume any liability or responsibility for any loss or damage arising from misuse or inappropriate use of the products.
7. The products have been designed and tested to function within controlled environmental conditions. Do not use products under conditions that deviate from methods or applications specified in this datasheet. Failure to employ the products in the proper applications can lead to deterioration, destruction or failure of the products. We shall not be responsible for any bodily injury, fires or accident, property damage or any consequential damages resulting from misuse or misapplication of the products.
8. **Quality Warranty**
  - 8-1. **Quality Warranty Period**

In the case of a product purchased through an authorized distributor or directly from us, the warranty period for this product shall be one (1) year after delivery to your company. For defective products that occurred during this period, we will take the quality warranty measures described in section 8-2. However, if there is an agreement on the warranty period in the basic transaction agreement, quality assurance agreement, delivery specifications, etc., it shall be followed.
  - 8-2. **Quality Warranty Remedies**

When it has been proved defective due to manufacturing factors as a result of defect analysis by us, we will either deliver a substitute for the defective product or refund the purchase price of the defective product.

Note that such delivery or refund is sole and exclusive remedies to your company for the defective product.
  - 8-3. **Remedies after Quality Warranty Period**

With respect to any defect of this product found after the quality warranty period, the defect will be analyzed by us. On the basis of the defect analysis results, the scope and amounts of damage shall be determined by mutual agreement of both parties. Then we will deal with upper limit in Section 8-2. This provision is not intended to limit any legal rights of your company.
9. Anti-radiation design is not implemented in the products described in this document.
10. The X-ray exposure can influence functions and characteristics of the products. Confirm the product functions and characteristics in the evaluation stage.
11. WLCSP products should be used in light shielded environments. The light exposure can influence functions and characteristics of the products under operation or storage.
12. Warning for handling Gallium and Arsenic (GaAs) products (Applying to GaAs MMIC, Photo Reflector). These products use Gallium (Ga) and Arsenic (As) which are specified as poisonous chemicals by law. For the prevention of a hazard, do not burn, destroy, or process chemically to make them as gas or power. When the product is disposed of, please follow the related regulation and do not mix this with general industrial waste or household waste.
13. Please contact our sales representatives should you have any questions or comments concerning the products or the technical information.



**Nisshinbo Micro Devices Inc.**

**Official website**

<https://www.nisshinbo-microdevices.co.jp/en/>

**Purchase information**

<https://www.nisshinbo-microdevices.co.jp/en/buy/>