

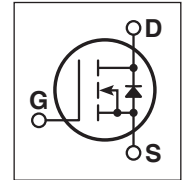

## Super Junction MOSFET

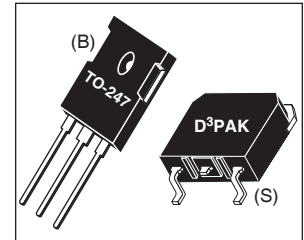

- Ultra Low  $R_{DS(ON)}$
- Low Miller Capacitance
- Ultra Low Gate Charge,  $Q_g$
- Avalanche Energy Rated
- Extreme  $dv/dt$  Rated
- Popular TO-247 or Surface Mount D<sup>3</sup> Package

### MAXIMUM RATINGS

 All Ratings:  $T_C = 25^\circ\text{C}$  unless otherwise specified.

Symbol	Parameter	APT31N60B_SCS(G)	UNIT
$V_{DSS}$	Drain-Source Voltage	600	Volts
$I_D$	Continuous Drain Current @ $T_C = 25^\circ\text{C}$	31	Amps
	Continuous Drain Current @ $T_C = 100^\circ\text{C}$	19	
$I_{DM}$	Pulsed Drain Current <sup>①</sup>	93	
$V_{GS}$	Gate-Source Voltage Continuous	±30	Volts
$P_D$	Total Power Dissipation @ $T_C = 25^\circ\text{C}$	255	Watts
	Linear Derating Factor	2.00	W/°C
$T_J, T_{STG}$	Operating and Storage Junction Temperature Range	-55 to 150	°C
$T_L$	Lead Temperature: 0.063" from Case for 10 Sec.	260	
$dv/dt$	MOSFET $dv/dt$ Ruggedness ( $V_{DS} = 480\text{V}$ )	50	V/ns
$I_{AR}$	Avalanche Current <sup>②</sup>	11	Amps
$E_{AR}$	Repetitive Avalanche Energy <sup>②</sup>	1.2	mJ
$E_{AS}$	Single Pulse Avalanche Energy <sup>③</sup>	800	

### STATIC ELECTRICAL CHARACTERISTICS

Symbol	Characteristic / Test Conditions	MIN	TYP	MAX	UNIT
$V_{(BR)DSS}$	Drain-Source Breakdown Voltage ( $V_{GS} = 0\text{V}, I_D = 250\mu\text{A}$ )	600			Volts
$R_{DS(on)}$	Drain-Source On-State Resistance <sup>②</sup> ( $V_{GS} = 10\text{V}, I_D = 18\text{A}$ )			0.100	Ohms
$I_{DSS}$	Zero Gate Voltage Drain Current ( $V_{DS} = 600\text{V}, V_{GS} = 0\text{V}$ )			10	$\mu\text{A}$
	Zero Gate Voltage Drain Current ( $V_{DS} = 600\text{V}, V_{GS} = 0\text{V}, T_C = 150^\circ\text{C}$ )		TBD		
$I_{GSS}$	Gate-Source Leakage Current ( $V_{GS} = \pm 20\text{V}, V_{DS} = 0\text{V}$ )			±100	nA
$V_{GS(th)}$	Gate Threshold Voltage ( $V_{DS} = V_{GS}, I_D = 1.2\text{mA}$ )	2.1	3	3.9	Volts

 CAUTION: These Devices are Sensitive to Electrostatic Discharge. Proper Handling Procedures Should Be Followed.

 APT Website - <http://www.advancedpower.com>

"COOLMOS™ comprise a new family of transistors developed by Infineon Technologies AG. "COOLMOS" is a trademark of Infineon Technologies AG."

### DYNAMIC CHARACTERISTICS

APT31N60B\_SCS(G)

Symbol	Characteristic	Test Conditions	MIN	TYP	MAX	UNIT
$C_{iss}$	Input Capacitance	$V_{GS} = 0V$ $V_{DS} = 25V$ $f = 1 \text{ MHz}$		3055		pF
$C_{oss}$	Output Capacitance			3260		
$C_{rss}$	Reverse Transfer Capacitance			28		
$Q_g$	Total Gate Charge <sup>⑤</sup>	$V_{GS} = 10V$ $V_{DD} = 400V$ $I_D = 18A @ 25^\circ C$		65	85	nC
$Q_{gs}$	Gate-Source Charge			14		
$Q_{gd}$	Gate-Drain ("Miller") Charge			22		
$t_{d(on)}$	Turn-on Delay Time	<b>RESISTIVE SWITCHING</b> $V_{GS} = 15V$ $V_{DD} = 400V$ $I_D = 18A @ 25^\circ C$ $R_G = 3.3\Omega$		10		ns
$t_r$	Rise Time			5		
$t_{d(off)}$	Turn-off Delay Time			110		
$t_f$	Fall Time			5		
$E_{on}$	Turn-on Switching Energy <sup>⑥</sup>	<b>INDUCTIVE SWITCHING @ 25°C</b> $V_{DD} = 400V, V_{GS} = 15V$ $I_D = 18A, R_G = 4.3\Omega$		290		$\mu J$
$E_{off}$	Turn-off Switching Energy			125		
$E_{on}$	Turn-on Switching Energy <sup>⑥</sup>	<b>INDUCTIVE SWITCHING @ 125°C</b> $V_{DD} = 400V, V_{GS} = 15V$ $I_D = 18A, R_G = 4.3\Omega$		170		
$E_{off}$	Turn-off Switching Energy			100		

### SOURCE-DRAIN DIODE RATINGS AND CHARACTERISTICS

Symbol	Characteristic / Test Conditions	MIN	TYP	MAX	UNIT
$I_S$	Continuous Source Current (Body Diode)			18	Amps
$I_{SM}$	Pulsed Source Current <sup>①</sup> (Body Diode)			93	
$V_{SD}$	Diode Forward Voltage <sup>④</sup> ( $V_{GS} = 0V, I_S = -18A$ )			1.2	Volts
$t_{rr}$	Reverse Recovery Time ( $I_S = -18A, di_S/dt = 100A/\mu s$ )		450		ns
$Q_{rr}$	Reverse Recovery Charge ( $I_S = -18A, di_S/dt = 100A/\mu s$ )		12		$\mu C$
$dv/dt$	Peak Diode Recovery $dv/dt$ <sup>⑦</sup>			4	V/ns

### THERMAL CHARACTERISTICS

Symbol	Characteristic	MIN	TYP	MAX	UNIT
$R_{\theta JC}$	Junction to Case			0.5	$^\circ C/W$
$R_{\theta JA}$	Junction to Ambient			62	

- ① Repetitive Rating: Pulse width limited by maximum junction temperature
- ② Repetitive avalanche causes additional power losses that can be calculated as  $P_{AV} = E_{AR} \cdot f$
- ③ Starting  $T_j = +25^\circ C$ ,  $L = 33.23mH$ ,  $R_G = 25\Omega$ , Peak  $I_L = 11A$
- ④ Pulse Test: Pulse width < 380 $\mu s$ , Duty Cycle < 2%

- ⑤ See MIL-STD-750 Method 3471
- ⑥  $E_{on}$  includes diode reverse recovery. See figures 18, 20.
- ⑦ We do not recommend using this CoolMOS™ product in topologies that have free wheeling load current conducted in the body diode that is hard commutated. The current commutation is very "snappy", resulting in high di/dt at the completion of commutation, and the likelihood of severe over-voltage transients due to the resulting high dv/dt.

APT Reserves the right to change, without notice, the specifications and information contained herein.

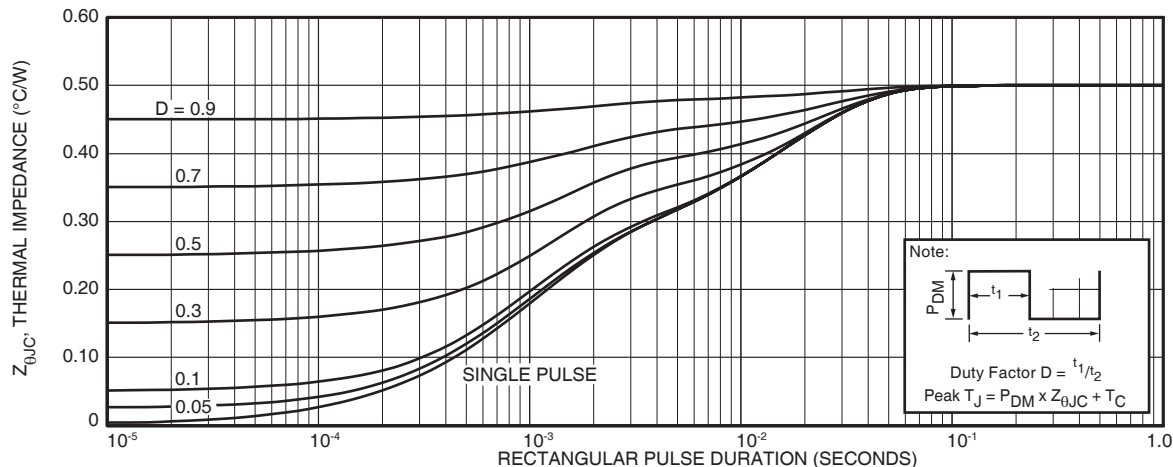

FIGURE 1, MAXIMUM EFFECTIVE TRANSIENT THERMAL IMPEDANCE, JUNCTION-TO-CASE vs PULSE DURATION

# Typical Performance Curves

APT31N60B\_SCS(G)

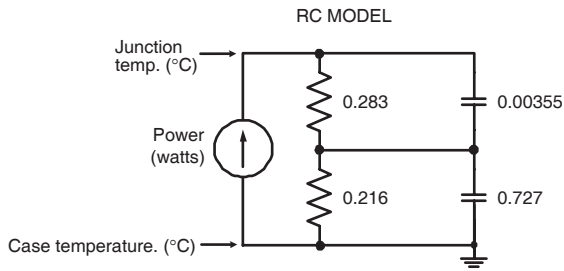

FIGURE 2, TRANSIENT THERMAL IMPEDANCE MODEL

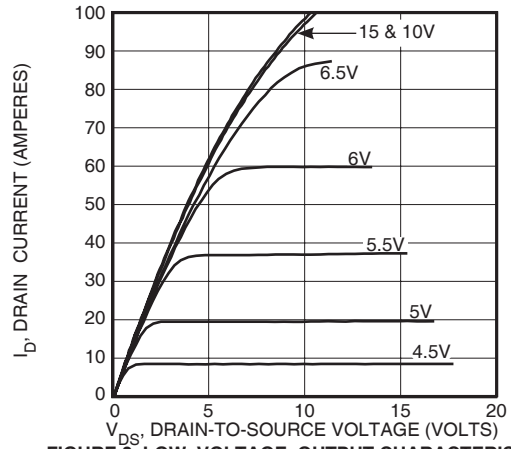

FIGURE 3, LOW VOLTAGE OUTPUT CHARACTERISTICS

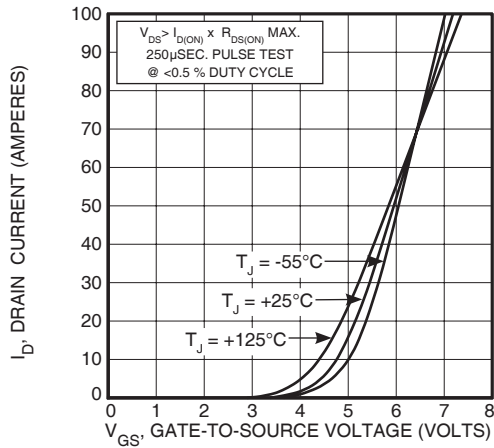

FIGURE 4, TRANSFER CHARACTERISTICS

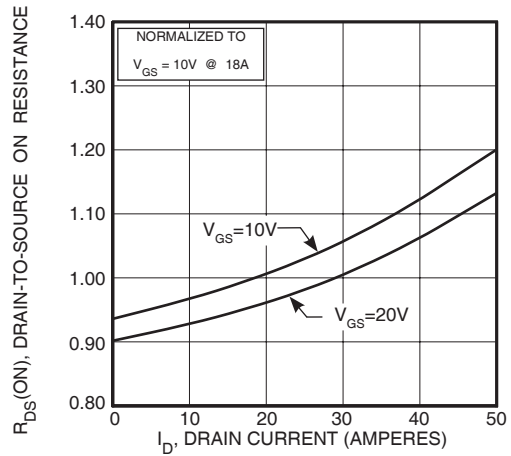

FIGURE 5,  $R_{DS(ON)}$  vs DRAIN CURRENT

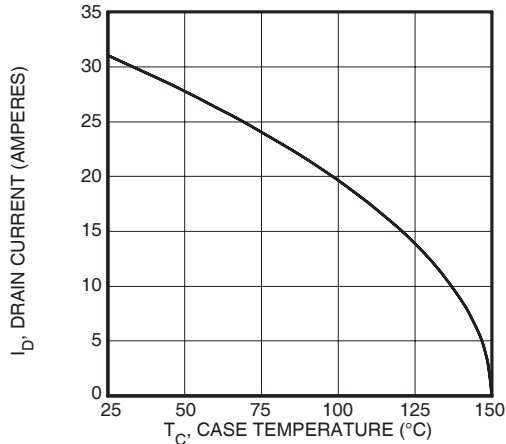

FIGURE 6, MAXIMUM DRAIN CURRENT vs CASE TEMPERATURE

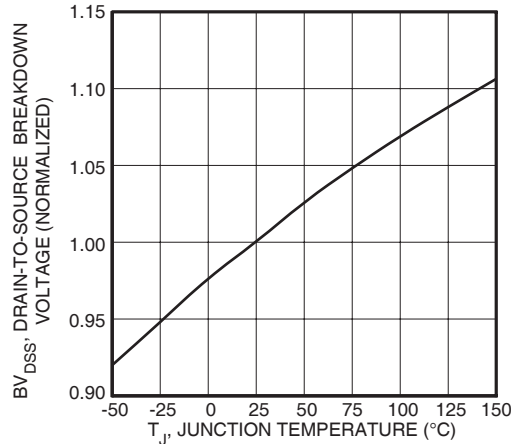

FIGURE 7, BREAKDOWN VOLTAGE vs TEMPERATURE

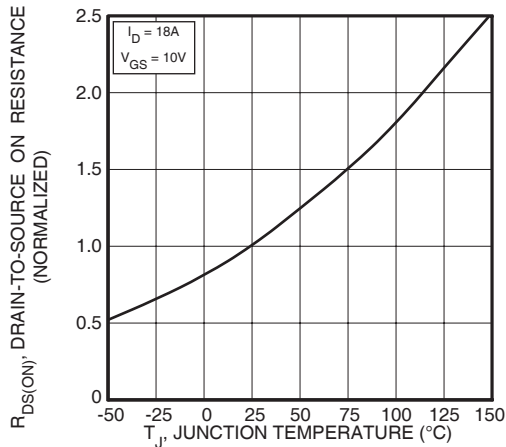

FIGURE 8, ON-RESISTANCE vs. TEMPERATURE

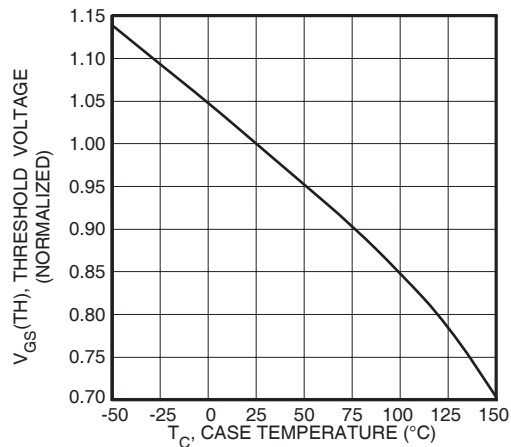

FIGURE 9, THRESHOLD VOLTAGE vs TEMPERATURE

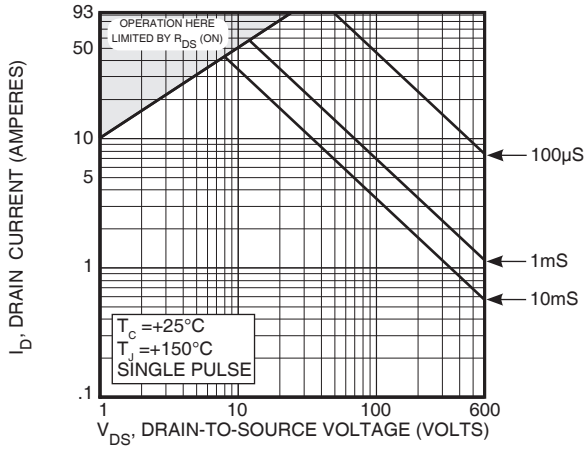

FIGURE 10, MAXIMUM SAFE OPERATING AREA

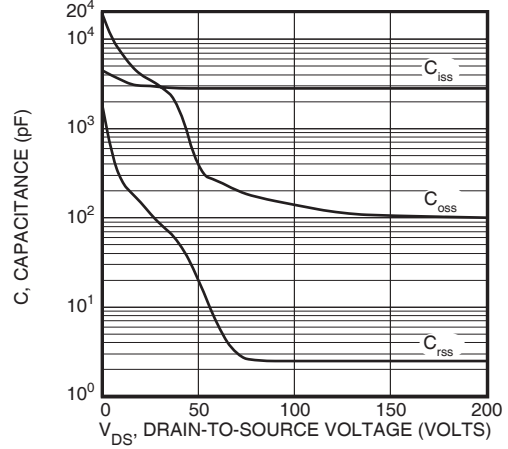

FIGURE 11, CAPACITANCE vs DRAIN-TO-SOURCE VOLTAGE

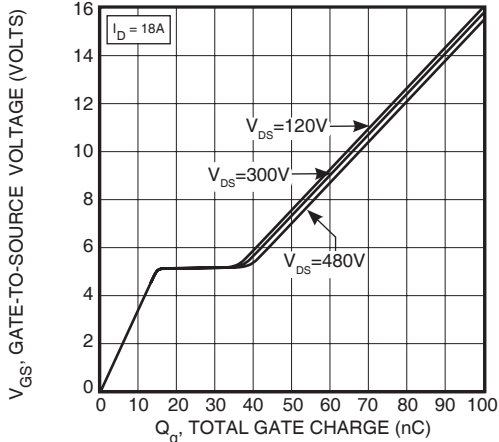

FIGURE 12, GATE CHARGE vs GATE-TO-SOURCE VOLTAGE

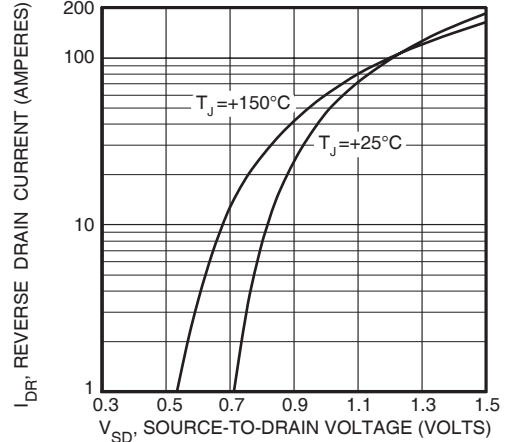

FIGURE 13, SOURCE-DRAIN DIODE FORWARD VOLTAGE

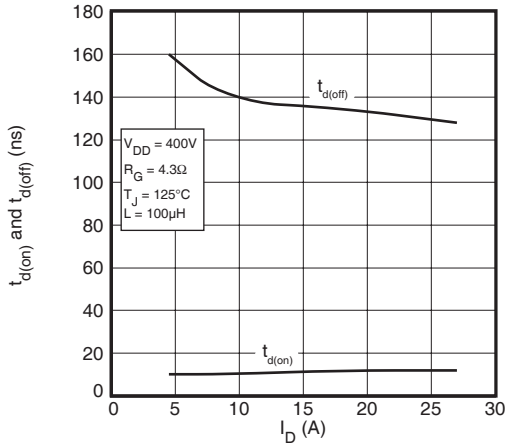

FIGURE 14, DELAY TIMES vs CURRENT

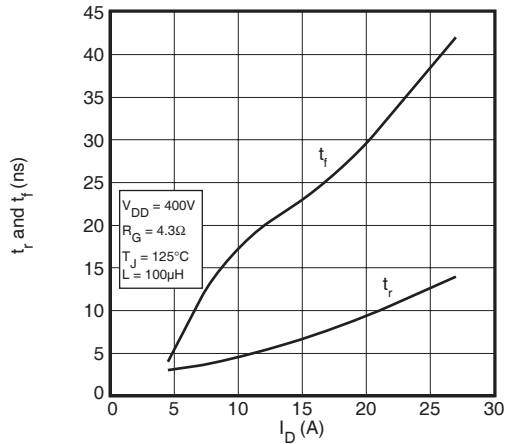

FIGURE 15, RISE AND FALL TIMES vs CURRENT

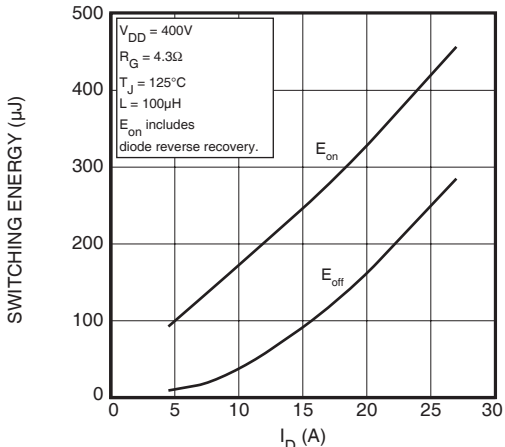

FIGURE 16, SWITCHING ENERGY vs CURRENT

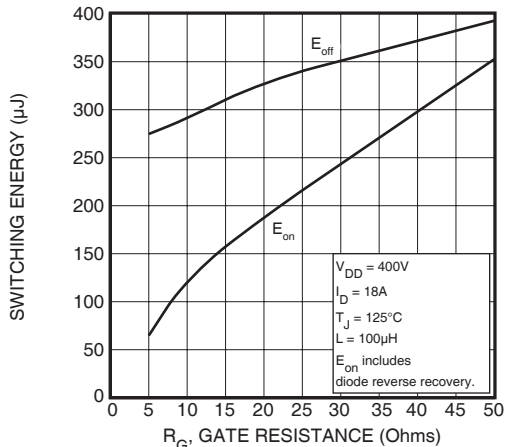

FIGURE 17, SWITCHING ENERGY vs. GATE RESISTANCE

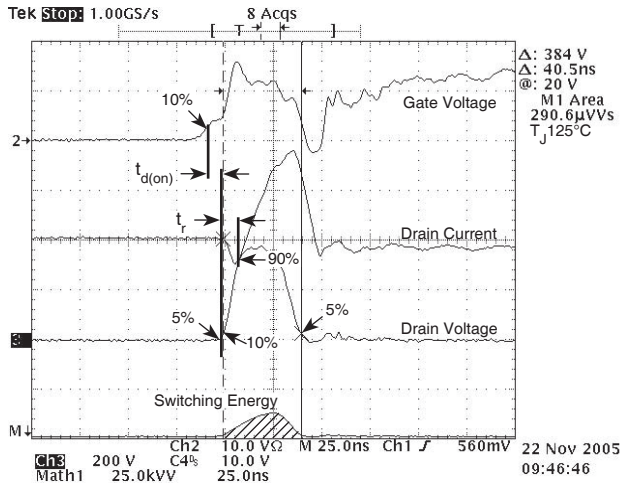

Figure 18, Turn-on Switching Waveforms and Definitions

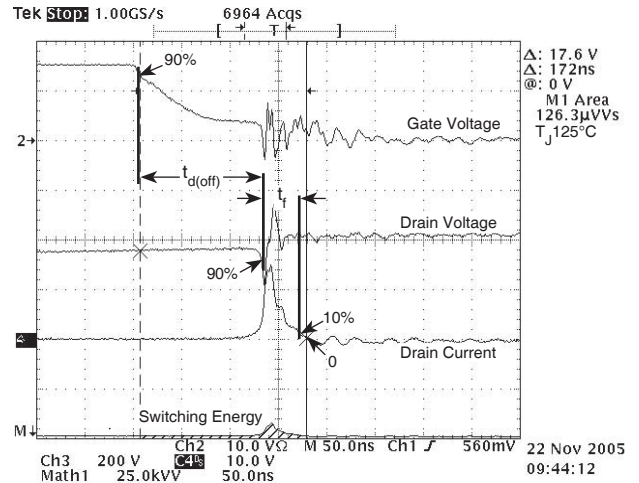

Figure 19, Turn-off Switching Waveforms and Definitions

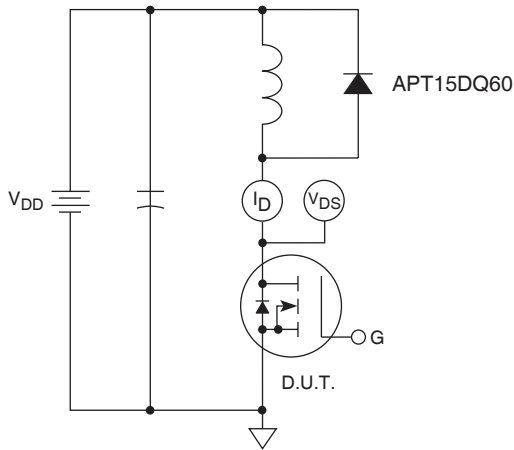
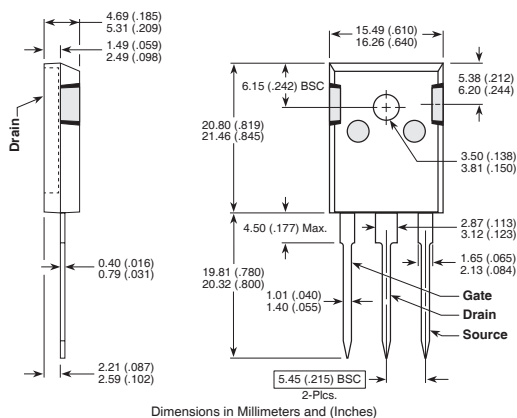

Figure 20, Inductive Switching Test Circuit

TO-247 Package Outline

e1 SAC: Tin, Silver, Copper



Dimensions in Millimeters and (Inches)

APT's products are covered by one or more of U.S. patents 4,895,810 5,045,903 5,089,434 5,182,234 5,019,522

5,262,336 6,503,786 5,256,583 4,748,103 5,283,202 5,231,474 5,434,095 5,528,058 and foreign patents. US and Foreign patents pending. All Rights Reserved.

D<sup>3</sup>PAK Package Outline

e3 100% Sn

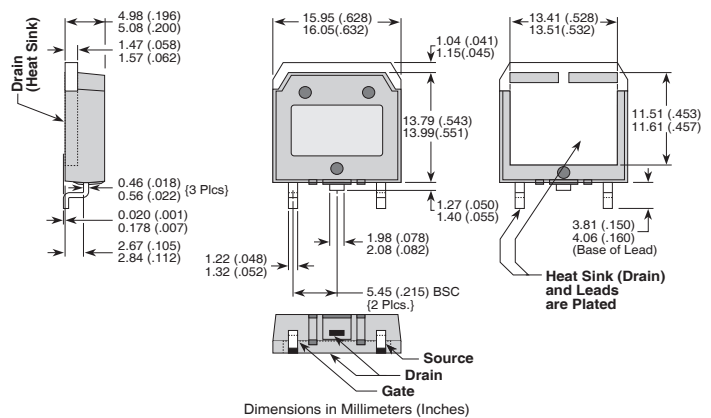

Dimensions in Millimeters (Inches)